



Evaluation of Legal Strategies for the Reduction of Plastic Bag Consumption

Citation

Chasse, Catherine. 2018. Evaluation of Legal Strategies for the Reduction of Plastic Bag Consumption. Master's thesis, Harvard Extension School.

Permanent link

<http://nrs.harvard.edu/urn-3:HUL.InstRepos:42004017>

Terms of Use

This article was downloaded from Harvard University's DASH repository, and is made available under the terms and conditions applicable to Other Posted Material, as set forth at <http://nrs.harvard.edu/urn-3:HUL.InstRepos:dash.current.terms-of-use#LAA>

Share Your Story

The Harvard community has made this article openly available.
Please share how this access benefits you. [Submit a story](#).

[Accessibility](#)

Evaluation of Legal Strategies for the Reduction of Plastic Bag Consumption

Catherine Chasse

A Thesis in the Field of Sustainability and Environmental Management

For the Degree of Master of Liberal Arts in Extension Studies

Harvard University

May 2018

Copyright 2018 Catherine Chasse

Abstract

In the grand scheme of human history lightweight plastic shopping bags have been present for an infinitesimal amount of time. However, their impacts have been substantial. An estimated one trillion plastic bags are used worldwide every year. Their excessive use and short lifespan are linked to many environmental issues such as litter, wildlife deaths and fossil fuel use. For these reasons, many governmental bodies, non-governmental organizations as well as the retail and grocery sectors worldwide have attempted to reduce their consumption of plastic bags in order to lessen their environmental impacts.

This thesis seeks to identify policies and regulations from the local to national levels of government in order to identify the most effective means of reducing the use of plastic bags. More than 450 initiatives were identified, mapped and analyzed throughout the world. Over 100 countries have had or are currently under a strategy aimed at reducing lightweight plastic bag consumption in their nation. A website (<https://chasseccatherine5.wixsite.com/plasticbagregulation>) containing the identified and mapped initiatives was created facilitate access to these strategies. The majority of strategies that have been enacted are locally driven. In the many actions taken to reduce the use of plastic bags, five main strategies were recognized: bans, levies, voluntary actions, recycling programs and bans combined with a levy. Many variations exist within these strategies, such as mandate or suggestion, focus on importer or consumer, provision of alternatives and education, advance consultation, active enforcement, advanced consultation, monitoring of results and responsive adjustment of fees. Some areas have

complete bans on plastic bags whereas others only ban certain types such as non-biodegradable plastic bags, non-compostable plastic bags or plastic bags under a certain wall thickness.

The most effective strategies at each level of government were determined based on reduction in plastic bag use following implementation of the initiatives. The results show that although bans are the most frequently chosen actions, they are not always the most effective at getting reductions. However, based on available data, all strategies analyzed were shown to be effective to some degree. Nevertheless, some had more evidence of success than others. Therefore, a model was constructed based on this evidence. The results suggest that the most effective model consists of a national directive establishing reduction targets or a mandatory national levy, regional levies and local bans. This model was applied to Canada in order to project the expected reduction in plastic bag use within the country if it were to adopt the model. Results suggest that by adopting this reduction strategy, Canada could decrease by at least 80% its use of plastic bags in each province within 10 years.

It is hoped that the results of this thesis will facilitate prudent decision-making with regard to plastic bag management and could be utilized as a framework for many countries.

Dedication

For Mom and Dad whom without, this thesis would not have been possible. Thank you for your constant inspiration, advice and support throughout my life and my academic endeavors. For my siblings and closest friends, whose encouragements, laughter and helpful distractions kept me going.

Acknowledgments

I would like to express my greatest appreciation to all those who offered their support, guidance and advice throughout this research project.

Rick Reibstein, JD. Environmental Attorney and Consultant. Lecturer in Environmental Law at Boston University and Continuing Education faculty at Harvard. As my thesis director, Professor Reibstein provided invaluable advice, guidance and feedback throughout the development of this research project.

Dr. Mark Leighton. Associate director and senior research advisor in the Sustainability Program at the Harvard Extension school. Dr. Leighton provided tremendous support throughout the beginning stages of this thesis. By reviewing multiple versions of the proposal, Dr. Leighton's guidance helped shape this research.

George Clark. Environmental Research Librarian. George's exceptional knowledge of the Harvard research library were of great guidance in the initial research of the thesis.

Table of Contents

Abstract	iii
Dedication	v
Acknowledgments	vi
List of Tables	x
List of Figures	xi
Acronyms and Definitions	xiii
I. Introduction	1
Research Significance and Objectives	1
Background	2
History of Plastic Bags	3
Life Cycle Assessment of a Plastic Bag	5
Environmental Impacts of Plastic Bags	8
Plastic Bag Policies and Regulations	10
National Initiatives	11
International Initiative	13
Regional Initiatives	14
Local Initiatives	16
The Plastic Bag Issue in Canada	17
Research Question, Hypotheses and Specific Aims	19
II. Methods	21
Data Collection	21

Spatial Analysis.....	23
Policy Analysis	28
Application to Canada	32
Research limitations	33
III. Results	34
National Initiatives.....	35
Effectiveness of a Nationwide Ban	38
Effectiveness of a Nationwide Levy.....	41
Effectiveness of National Bans Combined with a Levy.....	48
Effectiveness of National Voluntary Measure	52
Regional Initiatives	56
Effectiveness of a Regional Ban	58
Effectiveness of a Regional Levy.....	62
Effectiveness of a Regional Ban Combined with a Levy.....	64
Effectiveness of Regional Voluntary Measures	65
Effectiveness of Regional Recycling Programs	68
Local Initiatives	70
Effectiveness of a Local Ban	71
Effectiveness of a Local Levy	74
Effectiveness of a Local Ban Combined with a Levy	76
Effectiveness of Local Voluntary Measures	78
Application in Canada	79
Suggested Plastic Bag Reduction Model	80

Projected Effects of the Model in Canada81

IV. Discussion 84

 Conclusion91

Appendix A: Worldwide National Initiatives93

Appendix B: Worldwide Regional Initiatives118

Appendix C: Worldwide Local Initiatives141

References191

List of Tables

Table 1. The environmental impact of a conventional lightweight plastic shopping bag	8
Table 2. National organization: an example of the Excel files	23
Table 3. Local organization: an example of the Excel files	26
Table 4. Variation in levy amounts imposed on consumers at the national level	43
Table 5. Change in plastic bag consumption one year after implementation of a national levy	46
Table 6. Countries having instituted a ban and levy on plastic bags	49
Table 7. Voluntary measures at the national level	52
Table 8. Results from voluntary initiatives led by the retail industry	54
Table 9. Results from voluntary initiatives led by governmental entities	56
Table 10. Variation in levy amounts imposed on consumers at the regional level	63
Table 11. Variation in levies at the local level	75

List of Figures

Figure 1. 1965 Plastic bag patent entitled “Bag with handle of weldable plastic material”	4
Figure 2. Flow diagram of the system boundaries applied in the UK Environment Agency study	6
Figure 3. Relative contribution of different lifecycle stages to the environmental impacts of a conventional lightweight plastic shopping bag	7
Figure 4. Annual per capita consumption of lightweight plastic shopping bags in Europe	14
Figure 5. Statewide policies and regulations in the United States	15
Figure 6. Pop-up window for Australia as shown in the web app	25
Figure 7. The Patton and Sawicki Six-Step Rationalist Model	29
Figure 8. Plastic bag regulations WebApp	34
Figure 9. Current national initiatives	36
Figure 10. Current popularity in decision-making at the national level	37
Figure 11. Proportion of the population subject to national initiatives	37
Figure 12. Trend in national decision-making through time	38
Figure 13. Per capita consumption of plastic bags in Ireland	44
Figure 14. Correlation between the national levy charge and reduction of plastic bags..	45
Figure 15. Changes in per capita consumption of plastic bags in the Maldives	48
Figure 16. Current regional initiatives	57
Figure 17. Trend in regional decision-making through time	58

Figure 18. Distribution of current regional initiatives based on regional population	58
Figure 19. Regional initiatives in Australia	61
Figure 20. Plastic bag reduction in the Northwest Territories and District of Columbia.	64
Figure 21. Regional initiatives in Canada	65
Figure 22. Reduction following voluntary initiatives in Canadian provinces	67
Figure 23. Statewide initiatives in the United States	68
Figure 24. Worldwide local plastic bag regulations	70
Figure 25. Trend in local decision-making through time	71
Figure 26. Plastic bag regulations in the USA	77
Figure 27. Business as usual consumption of plastic bags in Canada	82

Acronyms and Definitions

Biodegradable plastic bag – plastic bag that undergoes degradation resulting from the action of naturally occurring microorganisms such as bacteria, fungi and algae. These bags are made from plant-based materials such as corn and wheat starch.

Compostable plastic bag – plastic bag able to decompose in aerobic environments that are maintained under controlled temperature and humidity conditions to yield CO₂, water, inorganic compounds, and biomass at a rate consistent with other known compostable materials and that leaves no visible, distinguishable, or toxic residue.

High-Density Polyethylene (HDPE) – polyethylene consisting mainly of linear, or unbranched, chains with high crystallinity and melting point, and density of 0.96 or more, produced at low pressure and used chiefly for containers and articles made by injection modeling.

Lightweight plastic shopping bag (LPSB) – plastic shopping bag with a wall thickness between 15 and 100 microns which is intended for single-use.

Low-Density Polyethylene (LDPE) – highly branched polyethylene with low crystallinity and melting point, and a density of 0.91 to 0.94, prepared at very high pressures, and used mainly for sheeting, films, and packaging materials.

Oxo-degradable plastic bag – bags made of conventional polymers to which chemicals are added to accelerate the oxidation and fragmentation of the material under the action of UV light and/or heat, and oxygen.

Reusable shopping bag – checkout bag with handles that is specifically designed and manufactured for multiple reuse. These bags are usually made of cloth or other machine washable fabric that has handles or a durable plastic bag.

Single-use carrier bag – a bag that is not intended for multiple-use which is usually made wholly or mainly from paper or lightweight plastics. These also include biodegradable, compostable and oxo-(bio)degradable plastic bags.

Very lightweight plastic shopping bag – plastic shopping bags with a wall thickness below 15 microns which are required for hygiene purposes or provided as primary packaging for loose food when this helps to prevent food wastage.

Chapter I

Introduction

Lightweight plastic shopping bags (LPSB) are probably amongst the most ubiquitous consumer items on Earth. An estimated one-trillion single-use plastic bags are utilized each year around the world (Larsen & Venkova, 2014). These bags, made from polyethylene, are contributing to many environmental issues, which has become a rising concern for environmentalists. Following their use, LPSBs end up either in landfills or as litter on the landscape and in waterways and oceans. They are not biodegradable and can therefore take hundreds of years to decompose. As they do so, they release dangerous methane and carbon dioxide gases as well as toxic leachate into the soil, air, and water (Scientific American, 2015; Jalil, Mian & Rahman, 2013). For these reasons as well as the overuse and wasteful properties of disposable plastic bags, restrictions or bans on LPSBs have been called for by environmentalists who instead encourage the use of more durable and reusable alternatives.

Governmental authorities from the national to local levels worldwide have started implementing policies and regulations in an effort to reduce the use and impacts of these bags. Local communities in particular are seen by many as indispensable and their empowerment necessary in the fight against global challenges (United Nations, 2005), such as the plastic bag problem.

Research Significance and Objectives

This thesis research seeks to evaluate the effectiveness of policies and regulations

relating to the use and environmental impacts of LPSBs, from a local to national perspective. Effectiveness of a policy or regulation can be defined as “the extent to which a law can do the job it is intended to do and is considered the primary expression of legislative quality” (Mousmouti, 2014). The primary objective of this thesis is to examine the effectiveness of different legal models and determine which has been and would be most effective in reducing the use and environmental impacts of plastic bags. As Canadians consume many plastic bags every year another objective of this thesis is to examine the possible results associated with the implementation of the suggested legal model at different levels of government within this country. This will help gain a sense of the amount of waste and environmental impacts that could be eliminated. It is hoped that this thesis as well as the projected results from Canada will assist informed policymaking and facilitate prudent decision-making with regard to plastic bag management and could also be utilized as a framework for application in other countries.

Background

All around us, can be seen the evidence of the importance of the plastic industry. Plastics help make a wide range of useful, everyday items. Thanks to plastics, “our shampoo bottles don’t shatter in the shower, our cars weigh less and therefore use less fuel, and our home are well insulated and save energy” (Plastics Industry Association, 2017). Canada produces approximately “2% of the total world volume of plastic products” (Government of Canada, 2017). According to the Government of Canada (2017), the demand for plastic products worldwide, and in the country, is expected to continue growing faster than the economy as a whole.

Although they have been shown to have their benefits, plastics are nondurable and cause various environmental problems and litter our streets. One of the most often encountered plastic products polluting our landscapes is plastic bags. These bags are popular with consumers and retailers due to their lightness, convenience, and low costs. They are therefore quite widespread. The majority of plastic bags in circulation are lightweight, single-use, bags that can most often be found in supermarkets (Clean Up Australia [CUA], 2015). These bags are known as high density polyethylene (HDPE) bags. Canadians alone use between nine and 15 billion plastic shopping bags a year, enough to circle the earth 55 times (Suzuki, 2012). This equates to between 13 and 20 bags per household per week, or 5 to 8 bags per person per week. Unfortunately, these bags have a relatively short average useful life, during which they perform their purpose, estimated at 12 minutes (CUA, 2015). But their environmental impacts are long-lasting.

History of the Plastic Bag

LPSBs have been present for less than a century, but their impacts have been substantial. Patents relating to the manufacturing of LPSBs can be found dating back to the 1950s, where they were mostly used for industrial purposes (Rutan Poly Industries Inc., 2015). The plastic shopping bag as we know it today wasn't invented until the mid-1960s, when Swedish engineer, Sten Gustaf Thulin, came up with a method and design that created a tough but simple bag with a good carrying capacity. This new product, made from HDPE, was patented (Figure 1) in 1965 by Celloplast, the same company for which Thulin worked (U.S. Patent No.3,180,557). This allowed Celloplast to start manufacturing the product in Europe and the United States, giving it a virtual monopoly.

It didn't take long for other companies to notice the attraction of these bags and in 1977 the American petrochemical company Exxon Mobil overturned Celloplast's US patent (Rutan Poly Industries Inc., 2015) allowing many US companies to embark on the plastic bag manufacturing wave.

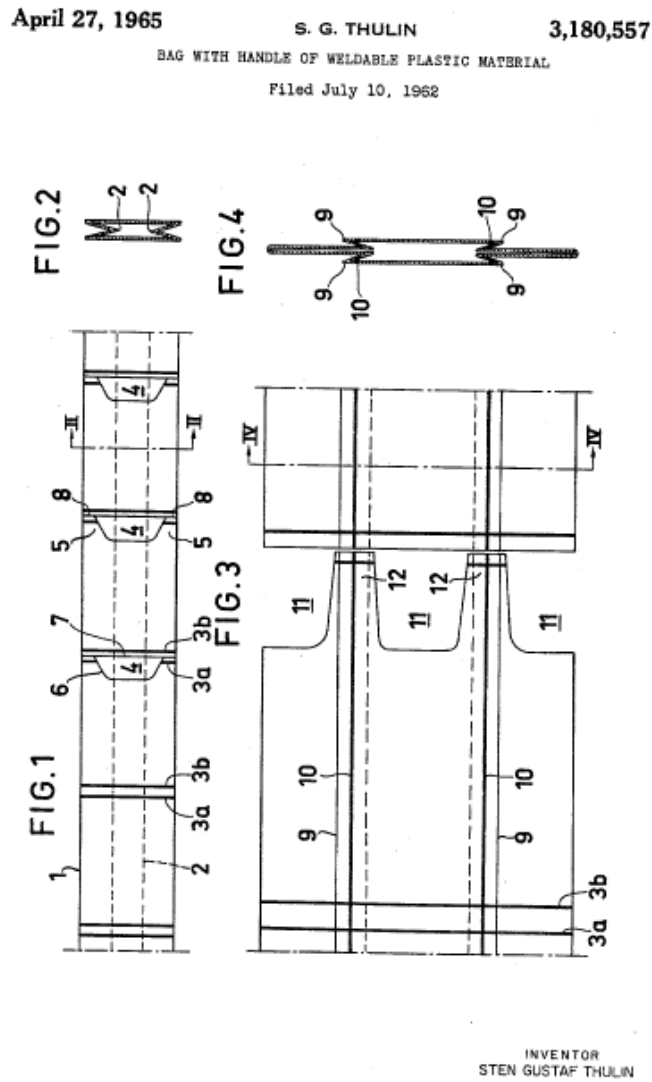

Figure 1. 1965 Plastic bag patent entitled “Bag with handle of weldable plastic material” (U.S. Patent No. 3,180,557)

However, it wasn't until 1982, when two of the largest grocery chains in the United States replaced their paper bags with the newer plastic alternative, that the plastic bag really started to make its mark. Although the introduction of LPSBs in supermarkets caused tremendous controversy, not only for their environmental properties but also due to customer preferences, their convenience won over business owners. By 1985, 75% of American grocery stores offered LPSBs over paper bags (Petru, 2014). Nowadays, LPSBs have become one of the most pervasive consumer items worldwide. It is said that “more [LPSBs] were produced in the first decade of the 21st century than the entire 20th century combined” (Equinox Center, 2013). This exponential growth of LPSBs has caught the attention of many environmentalists and others particularly since publicity about the Great Pacific Garbage Patch emerged in the late 1990s. Plastics in general make up the majority of marine debris. Their durability, low cost, and malleability have caused them to be used in more and more consumer and industrial products. Another reason for their high presence in marine environments is their inability to biodegrade. Instead, plastic breaks down into smaller pieces (National Geographic, 2017). Plastic bags have become such an environmental nuisance that many countries and even cities have taken it upon themselves to reduce their use (Roach, J., 2003).

Life Cycle Assessment of a Plastic Bag

Life Cycle Assessments (LCA) are “a common tool, used to quantify the environmental impacts of products throughout their life cycle” (Equinox Center, 2013). Many LCAs have been performed to assess the environmental impacts of many bag types in the hopes of determining the most environmentally friendly alternative. In 2006, the

United Kingdom Environmental Agency performed such a study to “assess the life cycle environmental impacts of the production, use and disposal of different carrier bags” (Edwards & Fry, 2011). Seven different carrier bags were assessed, among them, the lightweight HDPE shopping bag. Their cradle-to-grave analysis included all significant life stages from raw material extraction to waste management, through manufacturing and distribution. The system boundaries applied in this study (Figure 2) indicate that a comprehensive scope was applied throughout the life stages of HDPE bags. The study quantifies “all energy and materials used, tracked back to the extraction of resources, and the emissions from each life cycle stage, including waste management” (Edwards & Fry, 2011)

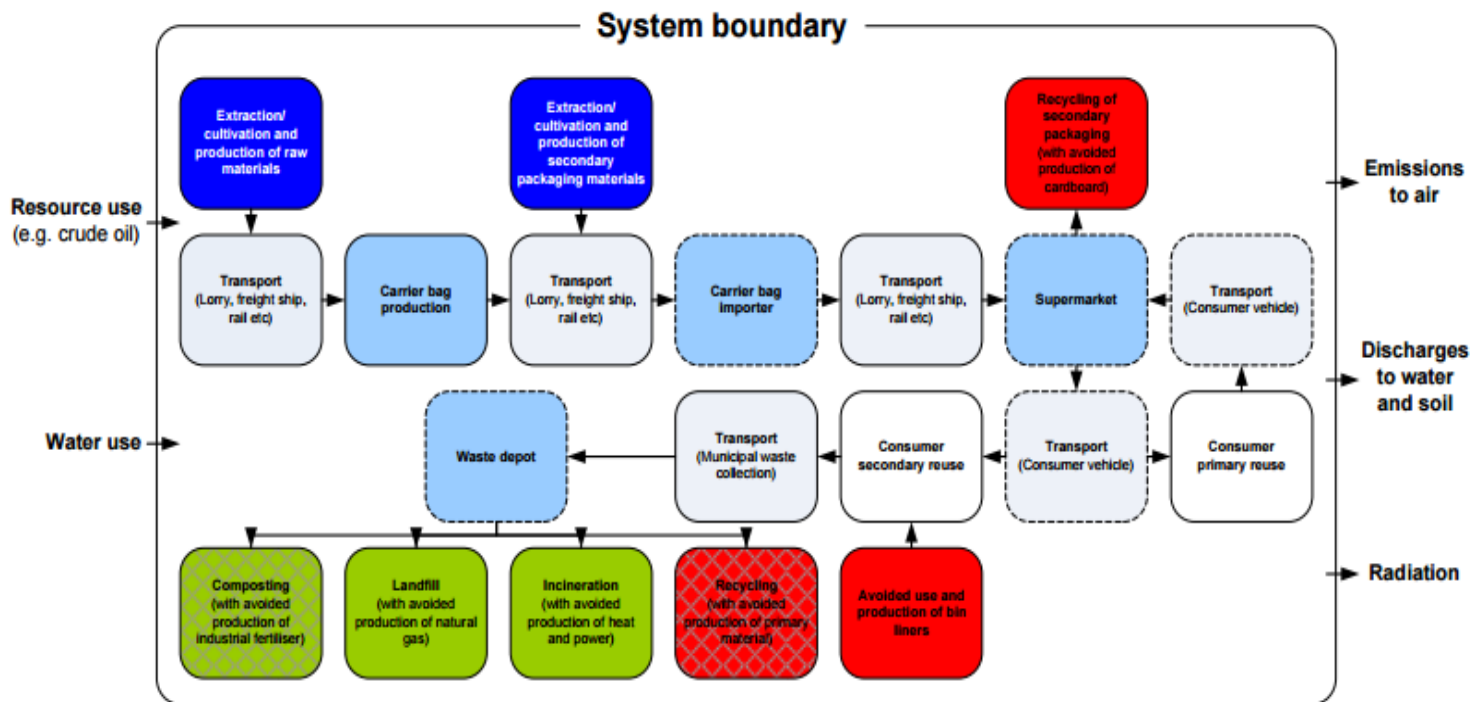

Figure 2. Flow diagram of the system boundaries applied in the UK Environment Agency study (Edwards & Fry, 2011).

The study concluded that the production process had the largest impact in five out of the eight impact categories – acidification, marine aquatic ecotoxicity, human toxicity,

terrestrial toxicity, and fresh water aquatic ecotoxicity (Figure 3). In the other three categories – global warming potential (GWP), abiotic depletion, and eutrophication – extraction/production of raw materials, had the highest impact.

These categories were then further analyzed to measure their specific environmental impacts (Table 1) in terms of their relevant units. For example, a single HDPE bag contributes 1.578kg CO₂eq. This indicates that for each plastic bag manufactured, 1.578kg CO₂eq of greenhouse gases (GHGs) is estimated to be contributed to global warming.

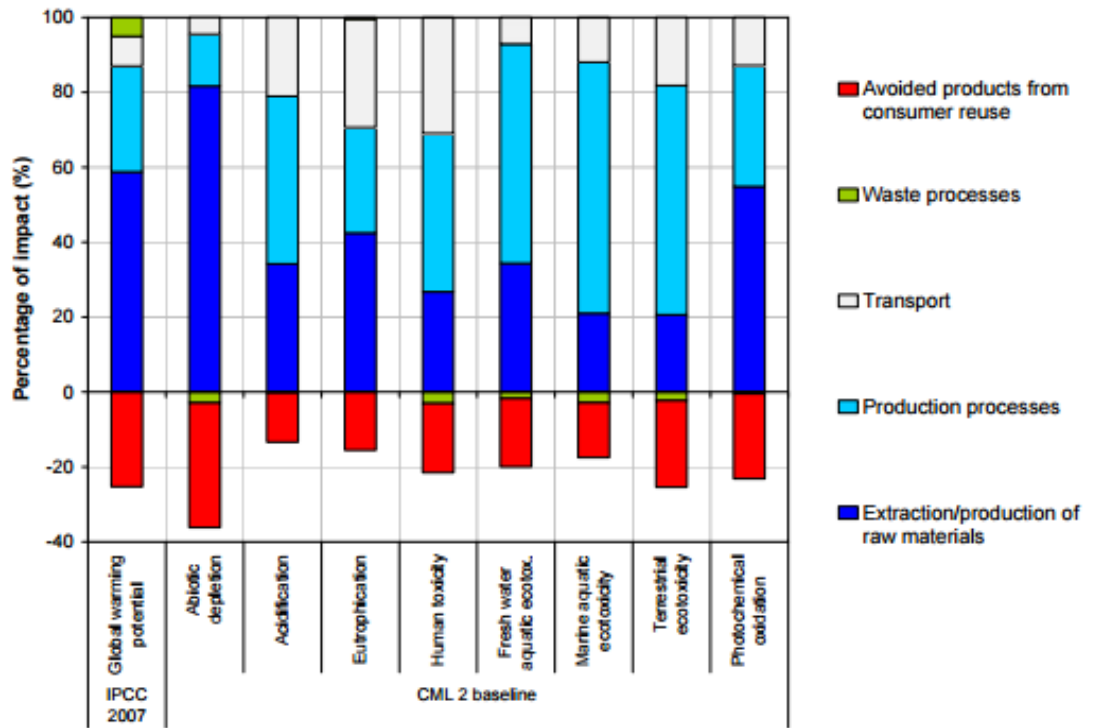

Figure 3. Relative contribution of different lifecycle stages to the environmental impacts of a conventional lightweight plastic shopping bag (Edwards & Fry, 2011)

Table 1. The environmental impact of a conventional lightweight plastic shopping bag

Method	Impact category	Unit	Total
IPCC 2007	Global warming potential	kg CO2 eq	1.578
CML 2 baseline	Abiotic depletion	g Sb eq	16.227
	Acidification	g SO2 eq	11.399
	Eutrophication	g PO4 ⁻⁻⁻ eq	0.775
	Human toxicity	kg 1,4-DB eq	0.211
	Fresh water aquatic ecotox.	g 1,4-DB eq	66.880
	Marine aquatic ecotoxicity	kg 1,4-DB eq	126.475
	Terrestrial ecotoxicity	g 1,4-DB eq	1.690
	Photochemical oxidation	g C2H4	0.531

(Edwards & Fry, 2011)

Throughout their life, plastic bags require many resources. For instance, the production, use and disposal of 1000 plastic bags is estimated to require a total of 457MJ of fossil fuels and feedstock – this includes energy from coal, oil and gas – and 31.15kg of public water supply (Chaffee & Yaros, 2007). When it comes to actual oil consumption, nearly 12 million barrels (1.9 billion liters) of petroleum oil are used to produce 100 billion LPSBs (Kazda, K., (2014). Given what is known about fossil fuel scarcity and the detrimental impacts of fossil fuel extraction and use on the environment, it is devastating to recognize such carelessly waste this limited resource.

Environmental Impacts of Plastic Bags

As demonstrated in the LCA above, plastic bags contribute to environmental issues such as global warming, ocean acidification and raw material use, due in part to the use of fossil fuels to produce them. However, plastic bags have also been shown to pose serious harm to agriculture as well as the marine ecosystem and to wildlife.

Impact on agriculture. Canada is among the world’s largest exporters of agricultural and agri-food products (Agriculture and Agri-Foods Canada, 2016). Unfortunately, discarded

plastic bags finding their way into the ground is damaging and seriously harmful to agriculture. These bags do not biodegrade, they take centuries to break down and when they do, the powdery plastic dusts interfere with the processes of all life forms, plant and animal, micro and macroorganisms by disturbing their metabolism and even choking some organisms (Jalil et al., 2013). These bags have caused tremendous harm to the growth of agricultural produce. Some agricultural crops cannot grow where plastic bags come to rest because their roots cannot move around or pierce the plastic bags in the soil due to their durability (Jalil et al., 2013). Reduction in soil fertility, decrease in nitrogen fixation, loss of nutrients in the soil, decrease in crop harvest, disruption of soil flora and fauna, and release of toxins are among the most significant negative impacts plastic bags pose on the environment (Jalil et al., 2013)

Impacts on marine ecosystems and wildlife. Scientists have identified five regions where debris, plastic included, are most abundant in the oceans. Debris accumulates in ocean gyres, which are areas of stationary, calm water, and can accumulate for years, leading to the name ‘garbage patch’ (National Geographic, 2012). Ten percent of all plastic bags consumed are said to make their way into our oceans (Parker, 2015), which causes devastating impacts on the marine environment. Unfortunately, when they make their way into the water, they can easily be mistaken for jellyfish. This makes them particularly dangerous. Turtles, seals, birds and whales mistakenly ingest these items, which block their intestines and cause the death of these animals (Plastic Waste Solutions, 2012). Plastic bags are among the most commonly ingested type of debris among sea turtles (National Oceanic and Atmospheric Association (NOAA), 2014). NOAA estimates that 100,000 marine mammals and millions of fish and seabirds are

killed every year by plastic debris. More than 10% of all species that have fallen victim to marine debris are said to be threatened with extinction (NOAA, 2014). Recognition of the damaging impacts makes it imperative that reduction strategies be put into place.

Photodegradation, toxicity and bioaccumulation. Instead of biodegrading, plastic bags undergo a process known as photodegradation, in which a substance's chemicals are broken down by the absorption of sunlight. When it comes to plastics, this process can be extremely slow. When they do degrade, however, a variety of toxins are released from most forms of plastic which can be harmful to the areas flora and fauna. Toxic microscopic particles can enter the food chain and concentrate in the food chain in a process known as bioaccumulation. Therefore, from the moment oil is extracted to produce LPSBs to the ingestion of toxins by a species following photodegradation of the plastic bag, LPSBs can have a wide range of environmental impacts.

Plastic Bag Policies and Regulations

Many non-governmental organizations (NGOs) and environmental activists pressure governments to act against LPSBs, often because of litter, harm to wildlife, and pollution (McLaughlin, 2016). Therefore, many countries and cities have started to implement policies and regulations aimed at restricting the use of LPSBs to reduce their impacts. Over the past few decades, there has been evidence of a significant shift in the international norms associated with disposable plastic bags (Clap & Swanston, 2009). There has been a shift in attitude around the world which has led to policies, expectations and new norms. In fact, no continent has been immune to the emergence of the anti-plastic bag movement. Although it has been widespread, the way in which it has been

translated into policy has varied greatly. From voluntary measures aimed at educating retailers and consumers alike, to outright bans on providing plastic bags as well as levies imposed on retailers or consumers, many initiatives have been adopted at all levels of government.

The effects of such policies have been mixed and consumers often debate whether banning or taxing plastic bags is as environmentally friendly as suggested (Hoskings & Tyson, 2007). It is therefore important to provide an analysis of these regulations to determine their effectiveness, and also to educate the public on this matter so that an informed public will call for the right policies. To date, however, few studies have thoroughly tested the effectiveness of such strategies (Chong, Karlan, Shapiro & Zinman, 2010).

This analysis of the regulations is intended to raise consciousness about the problem and about the options available for solving it. To fully understand the extent of the anti-plastic bag norm, it is important to look at the actions taken thus far by various authorities.

National Initiatives

In 2002, Ireland became the first country to enforce a mandatory plastic bag levy on consumers. “It had an immediate effect on consumer behavior with a decrease in [annual] plastic bag usage from an estimated 328 bags per capita to 12 bags per capita in 2014” (Ireland Department of Housing, Planning, Community and Local Government, 2016). Since Ireland’s pioneering act in 2002, many other countries have implemented their own levy on single-use plastic shopping bags. In 2016, the Netherlands instituted a

mandatory fee on plastic bags with a wall thickness superior to 15 microns. This added charge resulted in a 70% decrease in plastic bag consumption after one year of implementation (Pieters, J., 2017).

Many countries, particularly in Africa and Asia, are opting for a ban on plastic bags instead of a levy. The government of Bangladesh introduced a ban on plastic bags in 2002 to combat litter problems. Between 85% and 90% of all plastic bags in Dhaka in 2001 were said to be discarded in city streets after use (CUA, 2015). Plastic bags were also banned in Rwanda in 2008. Due in part to this ban, the country has become one of the cleanest in the world (Ekoualla, C., 2016).

Some countries such as Botswana, South Africa, Mozambique and China have combined the ban and levy approaches into a singular strategy. These countries ban plastic bags below a certain wall thickness and require retailers to charge for thicker plastic bags. The government of Israel instituted a hybrid ban and levy strategy in 2016 which prohibits supermarkets from distributing plastic bags less than 20 microns thick and requires them to charge for the use of thicker plastic bags. The government states that their goal is to “reduce the amount of polluting plastic bags that are produced in Israel, since these bags are very harmful to the environment” (Israel Ministry of Environmental Protection, 2017). After a year, plastic bag consumption decreased by 80%.

Unfortunately, the strategies at the national level have not always been successful (H.R. 2091, 2009; IRIN, 2011). This has been the case in the United States, where a plastic bag reduction act was introduced in Congress in 2009 but was not passed (H.R. 2091, 2009). However, policymakers in the United States have not been discouraged. A Trash Reduction Act was introduced in 2013 and 2015 by representatives from the

Democratic Party as an attempt to reduce the amount of plastic bags discarded in the country. Following their introduction in the House of Representatives, these bills were referred to the Committee on Ways and Means, and to the Committee on Natural Resources who then referred them to other subcommittees for further review. Both bills eventually died in Congress (H.R. 1686, 2013; H.R. 3977, 2015).

International Initiative

Although not all national governments have been able to implement bans or levies, action has been taken at the international level. In April 2015, the European Union (EU) issued a directive which requires member states to drastically reduce consumption of LPSBs. Countries are free to choose which means of reduction they desire to implement. However, consumption of LPSBs must not exceed an annual 90 bags per-capita by December 31st, 2019 and 40 bags per-capita per year by 2025 (European Union, 2015). Some member states such as Hungary and Poland have a long way to go (Figure 4), whereas others such as Denmark and Finland are already well below the threshold value imposed by the EU.

Due to this new law, countries all around Europe are actively seeking to reduce their consumption of LPSBs. For example, Estonia, which is among the largest consumers will now impose a fee on plastic bags (Republic of Estonia Ministry of Environment, 2016).

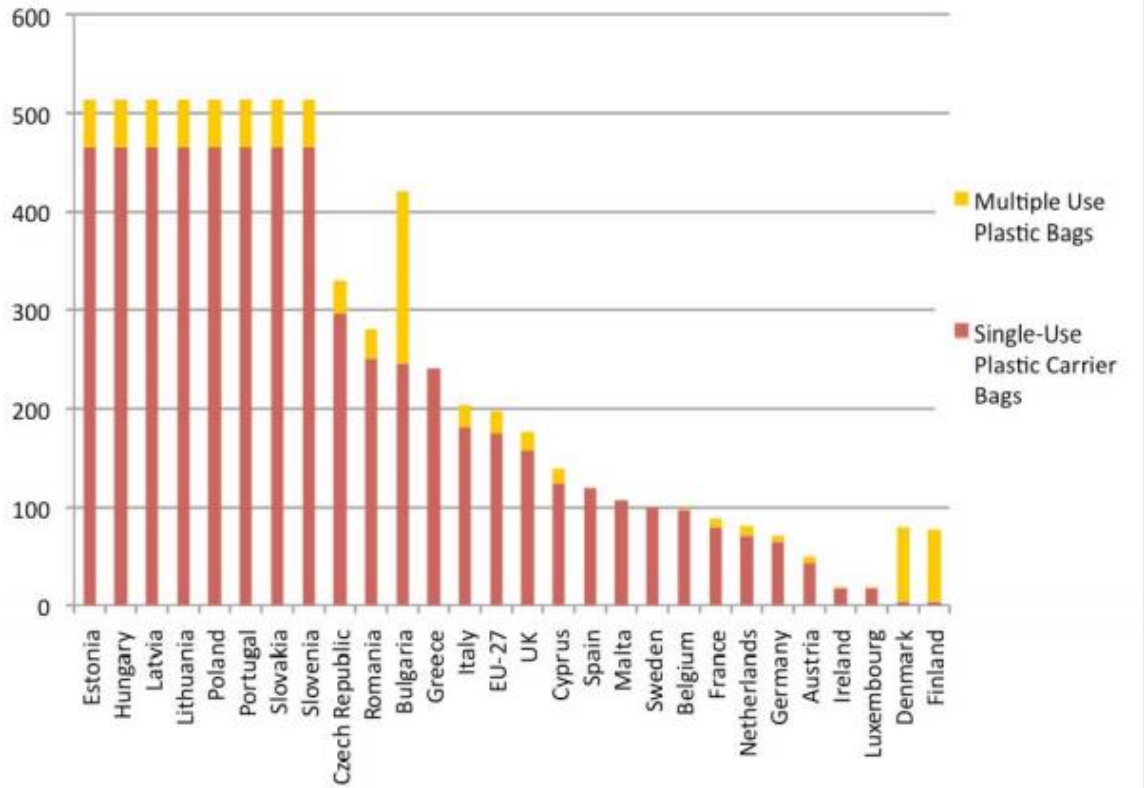

Figure 4. Annual per capita consumption of lightweight plastic shopping bags in Europe (Barbieri, 2015)

Regional Initiatives

While action is being taken at the national level, provinces and states take additional action to reinforce their needs. Where there is no national activity, some regions have also decided to take action of their own. These authorities may impose their own bans, levies or voluntary measures in an effort to mitigate the plastic bag problem within their territories. For example, even though Australia is quite active when it comes to reducing LPSB consumption, many of its states have taken action of their own and have decided to ban plastic bags. South Australia was the first state or territory to do so. They even impose a fine on retailers for selling or providing HDPE plastic bags (CUA,

plastics is particularly interesting. The state has a de facto statewide ban due to initiatives taken at the county level which prohibit non-biodegradable plastic bag distribution at checkouts (NCSL, 2016).

Local Initiatives

Most environmental norms are said to be adopted once an international agreement has been signed. However, due to community involvement, the norm can originate as “an ad hoc series of bottom-up events occurring simultaneously at different jurisdiction levels around the world” (Clapp & Swanston, 2009). In fact, it can originate as the result of policy adopted into law or through changes in behavior. Notwithstanding the example of the EU’s top-down establishment of policy, top-down evolution has not been the standard method of procedure when it comes to plastic bag reduction efforts. When it comes to LPSB consumption, much effort has been bottom-up. An international widespread agreement that this issue requires action is emerging as a result of a combination of actions taken at various levels of government. Communities have been particularly important actors in the emergence of the anti-plastic bag norms.

A popular measure being adopted by local communities is an outright ban on plastic bags. In 2007, San Francisco became the first city in the United States to ban plastic shopping bags (Scientific American, 2015). The San Francisco Department of Environment (2016) states that this law “will reduce litter and waste, as well as contamination in recycling and composting programs. [...] In addition, the law will improve water quality in the Bay and the ocean by reducing pollution”. Many other cities

in the US, such as Cambridge, Austin, and Seattle, have followed San Francisco's lead and enacted a plastic bag ban (NCSL, 2016).

In 2003, a few years before San Francisco's ban, Coles Bay in Tasmania became the first town in Australia to ban the infamous bags. Coles Bay sits on the edge of Freycinet National Park which is loaded with natural assets and many whales pass through during their migration season. The ban was implemented to reduce stress on wildlife and nature (Frickling, D., 2003). These examples show that local communities are concerned about the impacts they pose on their immediate environment and can have the power to act towards reducing their stress on natural habitats and resources.

The Plastic Bag Issue in Canada

The regulation of single-use plastic shopping bags in Canada is primarily a matter of waste management, which falls under municipal jurisdiction. The trend in Canada has therefore been to promote product stewardship, namely the 3R's – Reuse, Recycle, Reduce (Canadian Plastics Industry, 2012). Due to a lack of formal policy from the federal government, retailers, provinces, territories and cities are stepping in and implementing strategies of their own to reduce the use of LPSBs.

In 2009, Loblaw, a major grocery store chain, decided that they would no longer provide free plastic bags to their customers in an effort to reduce the environmental impact of these bags. All stores must now charge \$0.05CAD for each plastic bag requested. Part of the proceeds gained are given to the World Wildlife Fund (WWF) Canada to support their program aimed at helping Canadians reduce their environmental footprint by adopting simple planet-friendly actions, such as reducing their consumption

of single-use plastic bags (World Wildlife Fund Canada, 2009). In 2013, the chain reported that it had avoided giving 5 billion plastic bags and had donated \$5 million to WWF-Canada (Larsen & Venkova, 2014). Many other Canadian retailers have followed suit. These include IKEA Canada, Sobey, and Metro who have reported similar success in their reduction strategies (Larsen & Venkova, 2014). More recently, Walmart Canada also stopped providing free plastic bags to their customers. They hope to also remove plastic from their packaging processes and part of the proceeds from the bag fee will be used to support a plastic film recycling initiative (Walmart Canada, 2016).

Provincial governments have also implemented reduction strategies. The provincial norm seems to be a strategy aimed at the 3Rs approach. For example, in 2007, the Ontario government formed the Ontario Plastic Bag Reduction Task Group. Their goal was to “build a strong framework for reducing the number of carry-out plastic bags distributed in Ontario through application of the 3Rs approach” (Ontario Plastic Bag Reduction Task Group, 2010). Initiatives such as improved bagging practices, increased availability to reusable bags, more in-store recycling collection points, increased recycled content in plastic bags as well as greater consumer awareness of the 3Rs were key factors contributing to the reduction effort.

The task group hoped to reduce plastic bag distribution by 50% by 2012. In 2010, they announced that the goal was achieved with a 58% reduction over three years. Other provinces have also implemented similar initiatives. In Alberta, “four industry associations representing the major retailers of consumer products in Canada reached an agreement with the Government of Alberta to implement a province-wide strategy to reduce the distribution of single-use plastic bags” (Alberta Environmental and Parks,

2012; Retail Council of Canada, 2008). The three retail industry associations and their members collectively committed to achieve a 50% reduction in the number of plastic bags distributed by the end of 2013. They unfortunately did not meet their goal, having only reduced the distribution of LPSBs by 28%.

The Saskatchewan government considers that a 3Rs approach is the way to go. They state that “education about switching to reusable shopping bags and promotion of recycling of plastic bags is a more effective management method than a direct ban as it changed behavior and encourages recycling of plastic shopping bags” (Saskatchewan Association of Rural Municipalities, 2014). Instead of a 3Rs approach, the Northwest Territories decided to impose a \$0.25CAD on all non-reusable plastic and paper bags in 2010 (Canadian Plastics, 2011).

When it comes to municipal initiatives, many cities are adopting an outright ban. Leaf Rapids, Manitoba was the first city in Canada to ban single-use plastic bags in 2007 (Larsen & Venkova, 2014). This has influenced many other cities to do the same. These include Wood Buffalo Regional Municipality, Fogo Island, Huntingdon, Thompson, Varennes, Sainte-Julie, Brossard – a suburb of Montreal -, and even Montreal, which banned plastic bags in January 2018 (City of Montreal, 2016).

Research Question, Hypotheses and Specific Aims

What policies and/or regulations have been, or would be, the most effective at reducing the use and environmental impacts of LPSBs at a local to national level? This thesis seeks to determine the most successful strategies that have been or could be used to reduce the impacts associated with LPSB consumption. Effectiveness is measured by the

rate of decline in per-capita use following the implementation of a specific policy, when data is available, as well as public perception and awareness of the policy.

Although a hypotheses-driven research is not conventional when it comes to policy analysis, some results can be expected. For instance, at the local level, the decline in use of plastic bags is expected to be most effective when a ban is in place due to the smaller and more confined enforcement boundaries. However, at the provincial and national levels, levies are expected to be the most effective strategy. In fact, levies are expected to be most effective at these levels of government due to their potential to change consumer behavior on a larger scale. Enforcement is also expected to be less difficult than a ban within these jurisdictions due the expected difficulty of enforcing a ban on a larger area.

In order to see if this hypothesis is correct, it is necessary to examine scientific, social and legal aspects, including the logic behind the policies, the values and perspectives of the communities and the results of the implemented programs.

Specific Aims

The aims of this research are to identify policies and regulations at the local to national levels and to determine and understand the effect of these polices and regulations on the environment. This research also aims to determine the reasons behind policy failures to help in identifying the most effective policies and regulations. A final aim of this thesis is to produce a viable model for effective legislation.

Chapter II

Methods

The methods section of this thesis includes information on data collection as well as the three main components of this research: spatial analysis, policy analysis and the application of the selected policies in Canada. Research commenced with the collection of policy information at the international, national, regional and local levels worldwide. Once this collection of information was completed, a spatial analysis was conducted using ArcGIS Online and ArcGIS Pro to identify possible trends in decision-making. ArcGIS Online was also used to provide an accessible tool comprising a wide range of information on LPSB management around the world at all kinds of governmental levels. Then, based on the Patton and Sawicki six-step model, a policy analysis was conducted to identify the best practices in the reduction and management of LPSB consumption. The spatial and policy analyses were completed simultaneously. The final component of the research process was conducted by comparing a business-as-usual (BAU) scenario to the expected results following the implementation of the selected policies in Canada. Research limitations are also included at the end of this chapter.

Data Collection

The data collected throughout the research process came from a wide range of different sources. Firstly, national areas were identified based on the countries and dependencies listed in the Central Intelligence Agency (CIA) *World Factbook*. The CIA World Factbook is a one-stop reference site that provides “information on history, people,

government, economy, geography, communications, transportation, military and transnational issues for 267 world entities” (Central Intelligence Agency, 2017). Within these 267 world entities, 205 were selected as national entities based on their independence relative to other countries. Regional areas were then identified as the administrative divisions associated with each selected national entity in the CIA *World Factbook*. Regional areas include states, provinces, governorates, departments, regions, administrative atolls and administrative districts. Municipalities, counties, cities, towns and villages were considered as local units.

Once these entities were identified, information provided in bills, ordinances and regulations was collected using governmental websites and reports from all levels of government. These included sources such as the Cabo Verde Council of Ministers (national), the General Court of the Commonwealth for Massachusetts (regional) and the City of Montreal (local). News articles, peer-reviewed journals, conference presentations, non-governmental organization (NGO) websites and reports as well as company websites and reports were also used to identify other types of policies, such as voluntary initiatives and agreements, as well as consumption data.

The data collected was then organized using Microsoft Excel. Separate Excel files were created for each governmental level. These files (Table 2) incorporate information on population size as well as the presence of a plastic bag regulation and its type, status, year of enactment and a description of the policy. These files were later used to transfer the information gathered to ArcGIS Online for the spatial representation and analyses of the different policies.

Table 2. National organization: an example of the Excel files

FID	COUNTRY	ISO_CODE	POPULATION	PB_REGULATION	TYPE_of_REG	STATUS_OF_REG	YEAR	DESCRIPTION	PICTURE_URL	URL
1	Afghanistan	AF	33332025	No	-	-	-			
2	Albania	AL	3038594	No	-	-	-			
3	Algeria	DZ	40263711	No	-	-	-			
4	Andorra	AD	85660	Yes	Ban_Fee	Enacted	2012	In 2012, the gov	http://flagged	https://ww
5	Angola	AO	25800000	No	-	-	-			
6	Antigua and Barbuda	AG	93581	Yes	Ban	Enacted	2016	As of July 1st, 2	http://www.w	http://ww
7	Argentina	AR	43886748	No	-	-	-			
8	Aruba	AW	113648	Yes	Ban	Enacted	2017	In late June 201	https://uploac	http://ww
9	Armenia	AM	3051250	No	-	-	-			
10	Australia	AU	22992654	Yes	Voluntary	In progress	2017	Since 2013, the	http://wideba	https://ww
11	Austria	AT	8711770	Yes	Voluntary	Enacted	2017	Following the E	http://www.al	https://oc
12	Azerbaijan	AZ	9872765	No	-	-	-			
13	Bahamas	BS	327316	No	-	-	-			
14	Bahrain	BH	1378904	No	-	-	-			
15	Bangladesh	BD	156186882	Yes	Ban	Enacted	2002	In the late 1990	https://uploac	http://ww
16	Barbados	BB	291495	Yes	Voluntary	Enacted	2017	The Future Cen	https://uploac	http://futu
17	Belarus	BY	9570376	No	-	-	-			
18	Belgium	BE	11409077	Yes	Levy	Enacted	2007	In 2007, the Bel	https://i.ebay	http://dya
19	Belize	BZ	353858	No	-	-	-			

Spatial Analysis

ArcGIS Online was predominantly used to perform the spatial representation of plastic bag policy types around the world and to identify possible trends in decision-making by creating a web map which was published as a web app. ArcGIS Online is part of the ArcGIS web GIS platform. It provides a complete cloud-based geographic information system of the world in which users can deliver authoritative maps, analytics and geographic information to a wide audience (Fu, P. 2016). The ArcGIS web GIS platform also allows access to the Living Atlas of the World and ArcGIS Open Data which include thousands of datasets and web services that have been shared from around the world.

National and Regional Layer Creation

The methodology used to create the national and regional layers to be included in the web map and app was essentially comprised of the same overall steps. First, the Excel files, shown in table 2, were saved as CSV files to allow their importation into the web

map. However, these files did not provide location attributes and could therefore only be added as tables. To create polygon layers in which countries and regions could be color-coded depending on policy types the tables needed to be joined to corresponding polygon layers. Appropriate layers were found and added to the map using ArcGIS Open Data. The World Countries (Generalized) layer by ESRI, a polygon layer which provides country level boundaries was chosen to perform the national level analysis. Many features were provided within this layer. However, the most important ones were the country names and ISO codes. To perform the join features analysis, the national plastic bag regulations table was joined to the World Countries (Generalized) layer using a one-to-one analysis based on ISO codes. This created a new layer which incorporated both the information from the World Countries (Generalized) layer and the national plastic bags regulations table. This resulting layer was then saved as the “National Plastic Bag Regulations” layer.

When it comes to the regional analysis, eight separate layers were created in the same manner as for the national layer. The regional analysis was separated in different layers for added simplicity and organization. Therefore, layers were created for policies and regulation within Canadian provinces, USA states, Mexican states, Argentinian provinces, Indian states, Australian states, Malaysian states and a final layer for the remaining administrative divisions. To do so, the following layers from ArcGIS Open Data were used:

- Provinces and Territories of Canada by esri_canada
- USA States (Generalized) by esri
- Mexico Estado Boundaries 2014 by esri_dm

- Argentina Provincia Boundaries 2014 by esri_dm
- India States Boundaries 2016 by esri_dm
- WIL_TWT_ch11_Australia_Features by Maps.com_carto
- (Malaysia) Mean Household Income by demobd
- World First Order Administrative Boundaries 2016 by esri_dm

Corresponding tables were joined with the appropriate layers using a one-to-one analysis based on either ISO codes or location names, depending on what was most appropriate in each case, to create original layers with plastic bag regulation information at the regional level.

Once all original polygon layers were saved, countries and regions were color-coded based on policy or regulation types using the symbology tool. Pop-ups (Figure 6) were also enabled and configured so that clicking on a location in the web app would provide information on the country or region as well as its corresponding policy or regulation, when applicable. A link to additional information on the policy or regulation, when applicable, is also available in the pop-up window.



Figure 6: Pop-up window for Australia as shown in the web app

Local Layer Creation

The local layers were created as point feature layers instead of polygon feature layers. To do so, latitude and longitude coordinates were added in the local CSV files in addition to other features also found in the national and regional files (Table 3). The CSV files were imported to the web app as layers and the symbology tool was once again used to distinguish between policy and regulation types. Pop-ups were also configured such as in the national and regional layers.

Table 3. Local organization: an example of the Excel files

Country	City	Type	Year	Details	URL	Latitude	Longitude
Albania	Tirana	Voluntary	2017	A three-w	https://oc	41.32755	19.8187
Greece	Alonnisos	Ban_Fee	2015	The "Plast	http://tha	39.19686	23.89417
England	Modbury	Ban	2007	In May 200	https://w	50.34872	-3.89113
Belize	Belmopan	Voluntary	2014	In Novem	https://w	17.25101	-88.759
Belize	San Pedro	Voluntary	2015	In January	https://w	17.92137	-87.9611
Canada	Brossard	Ban	2016	In Februar	http://ww	45.45144	-73.4619
Canada	Calixa-Lavallee	Ban	2018	Conventic	https://w	45.7461	-73.2817
Canada	Contrecoeur	Ban	2018	Conventic	https://w	45.86541	-73.2413
Canada	Deux-Montagnes	Ban	2009	On July 1s	http://ww	45.54181	-73.8932
Canada	Huntingdon	Ban	2008	In January	https://w	45.08672	-74.1747
Canada	Montreal	Ban	2018	A ban on p	http://vill	45.50169	-73.5673
Canada	Saint-Amable	Ban	2018	Conventic	https://w	45.65638	-73.3004
Canada	Saint-Anselme	Ban	2009	A ban on e	https://w	46.62974	-70.9697
Canada	Sainte-Julie	Ban	2018	Conventic	https://w	45.5925	-73.3427
Canada	Sainte-Martine	Ban	2010	A ban on e	http://ww	45.25324	-73.7977
Canada	Varenes	Ban	2018	Conventic	https://w	45.68103	-73.4375
Canada	Vercheres	Ban	2018	Conventic	https://w	45.77334	-73.3527
Canada	Mont-Saint-Hilaire	Ban	2018	Plastic sho	https://w	45.56404	-73.179

Once all the national, regional and local layers were finalized, the visibility range of these layers were configured in a way that at a world glance, only national initiatives are shown. However, when zooming to a country, the national initiatives disappear to show in their stead, the regional and local initiatives.

Creating the Web App

When all layers were completed and configured adequately in the web map, the map was saved and shared by creating a web GIS app. A web GIS app is an application based on the web map that share both information and data and that is readily available on desktop, tablets, and smartphones. The web GIS app was created using Web AppBuilder for ArcGIS which offers various bits of functionality such as layouts and color schemes as well as a multitude of widgets such as legends, bookmarks and a search tool. Bookmarks were created for countries with a multitude of initiatives, such as Canada, Australia and the United States of America to provide richer functionality to the app.

Identifying Possible Trends

To determine if there were trends in decision-making at each level of government, bar graphs were created using Microsoft Excel. A total count of the occurrences of each type of initiative was conducted and corresponding graphs were created at the national, regional and local levels. Policies and regulations that have been proposed but have not yet passed were not included in the graphs.

Creating PDF Versions of the Map Layers

In order to include visual representations of the layers created in ArGIS Online in this thesis, PDF versions of the layers had to be created. To do so, ArcGIS Pro was used. ArcGIS Pro is the premier professional desktop GIS application from ESRI (ESRI, 2017). The “portal” feature of ArcGIS Pro connects to ArcGIS Online to allows users to retrieve

layers and maps created online and transfer them to the desktop application. Therefore, the layers created online at the national, regional and local levels were transferred to ArcGIS using this feature. Using the layout feature, legends, scale bars and north arrows were added to the individual layers to create individual maps. These maps were then exported to PDF in order to include them in the results section of this thesis.

Policy Analysis

Policy analysis is the “process through which we identify and evaluate alternative policies or programs that are intended to lessen or resolve social, economic, or physical problems” (Patton and Sawicki, 1986). A policy analysis was conducted to identify and evaluate policies related to the plastic bag consumption issue. The Patton & Sawicki six-step rationalist model (Figure 7) was chosen to undertake this analysis. This model is an extremely useful, structured method for dissecting the critical elements of policy in order to develop appropriate, logical, defensible recommendations and solutions.

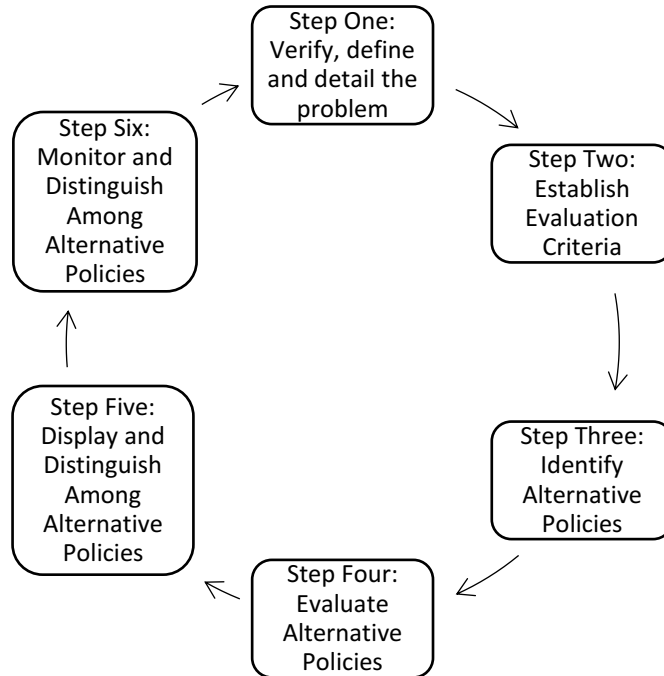

Figure 7: The Patton and Sawicki Six-Step Rationalist Model (Patton & Sawicki, 1986).

Verify, Define, and Detail the Problem

One of the key steps in this process is to adequately define the problem. It is the foundation for an efficient and effective outcome of the whole analysis. In this particular work, much of the defining and detailing of the problem was done in the introductory chapter. Extensive literature research was conducted to fully understand the problem and to identify its scope. It was shown that LPSBs, which have quickly become omnipresent consumer products, are causing environmental harm to the planet throughout their life cycle. Many policies have therefore emerged throughout the years, in an effort to combat this problem, but not all have been effective. Finding a more adequate way to tackle the issue is necessary in order to help reduce this particular environmental crisis.

Establish Evaluation Criteria

In order to compare, measure and select among alternatives, relevant criteria must be established. Factors such as effectiveness, legality and political acceptability must be considered. Effectiveness and political acceptability were determined based on consumer and retailer compliance as well as the reduction of LPSB consumption following the implementation of the different policies in terms of percent reduction. Level of enforcement and public awareness were also taken into consideration to discover if these were determining factors related to the success or failure of the various alternatives. Finally, due to the fact that this study was conducted with a worldwide perspective, cultural norms, such as government types and environmental concerns, also needed to be considered during the evaluation of the different policies.

Identify Alternative Policies

When generating alternatives, it is important to avoid settling prematurely on a certain number of options. Even the most seemingly insignificant alternative must be taken into consideration. In fact, when identifying possible alternative policies, many options must be considered before settling on a reduced few. This broad approach helps the policy maker – or citizen - to think outside the business as usual box to find possible alternatives that have not been thought of before, such as combining a few alternatives that could generate better results than the conventional approaches. Therefore, when researching alternatives, different factors were identified such as the types of plastic bags involved in the policies, governmental involvement levels as well as public awareness and education leading to, and following, the policy implementation. An alternative that

must always be considered is the status quo, or “do nothing”, alternative. This helps determine the baseline if there is no policy in place to alleviate the problem.

Evaluate Alternative Policies

This step consists of evaluating how each alternative benefit the criteria previously established. Additional data was collected from literature reviews, governmental websites and other reliable websites and sources. This data was used to determine the annual reduction rate of plastic bags for each initiative. If the data permitted it, linear graphs were created using the reduction data previously identified. This allowed for a better comprehension of the ultimate effectiveness of each policy and the result that is most significant. Case studies were then conducted to determine key factors in the success or failures of the policies. These included a more detailed analysis of the initiatives in Ireland, Rwanda, California, the Australian States as well as multiple towns in the United States, Canada and Australia.

Display and Distinguish Among Alternative Policies

Once the evaluation of alternatives was completed, the results were used to distinguish which alternatives, or key factors were most effective. These results list the degree to which criteria are met for each alternative. Within a strategy may also exist a variation in the key factors. Therefore, to fully determine the proper alternative to consider as the most effective, it was important to distinguish not only the types of policies but also the key factors within these policies. These included factors such as the

amount of the levy, and applicability, such as according to wall thickness or bag composition and means of implementing the policy, where appropriate.

Monitoring the Implemented Policy

An important part of policy analysis takes place once the policy has been implemented. This consists of monitoring the policy in order to identify its success or if modifications should be made to ensure better compliance. In fact, according to Patton and Sawicki (1986):

Even after a policy has been implemented, there may be some doubt whether the problem was resolved appropriately and even whether the selected policy is being implemented properly. These concerns require that policies and programs be maintained and monitored during implementation to assure that they do not change form unintentionally, to measure the impact they are having, to determine whether they are having the impact intended, and to decide whether they should be continued, modified, or terminated.

This analysis produced an assessment of which approach to the problem has been most effective, and this was then applied to Canada in order to project what might be expected following the implementation of the LPSB reduction strategies that experience suggests would be most effective. Although this is not a concrete monitoring of an existing policy model, it provides a crude approximation of expected success.

Application to Canada

The final component of this research was to select the best approach in order to build a model which was applied to Canada to project possible LPSB reduction in the next ten years if the country was to adopt the proposed policy model. To do so, it was important to identify the number of plastic bags used in the country at present. Plastic bag

consumption on a per-capita basis was then determined in order to determine the expected amount of LPSBs consumed in the next decade while taking into consideration the projected population growth. This status quo scenario was then used to identify the environmental impacts these bags could have on the Canadian environment if no action is undertaken. This includes determining the greenhouse gases (CO₂) released, fossil fuel and feedstock required as well as consumption of water and crude oil.

Scenarios were then created to determine the number of plastic bags saved and hence environmental impacts avoided when the national, regional and local initiatives are applied.

Research Limitations

The research was limited by the amount of available data relative to the reduction of LPSBs following the implementation of a policy or regulation. In fact, due to the fact that many policies have been enacted in the past few years only, long-term data was not readily available. Few governmental bodies require compliance monitoring and there are few official reports on the results of their initiatives.

Chapter III

Results

The results section of this thesis presents the outcomes of the three main components researched: spatial analysis, policy analysis and application to Canada. The first part of this thesis consisted of identifying as many policies as possible within all levels of government throughout the world. An online platform incorporating all these policies within a map was created to provide a one-stop access for governmental bodies, NGOs, and/or the general public interested in the reduction of LPSB consumption. The app (Figure 8) provides information to help interested bodies identify policies in their area, but also includes information related to the types of policies implemented throughout the world. It consists of three main layers: national initiatives, regional initiatives and local initiatives.

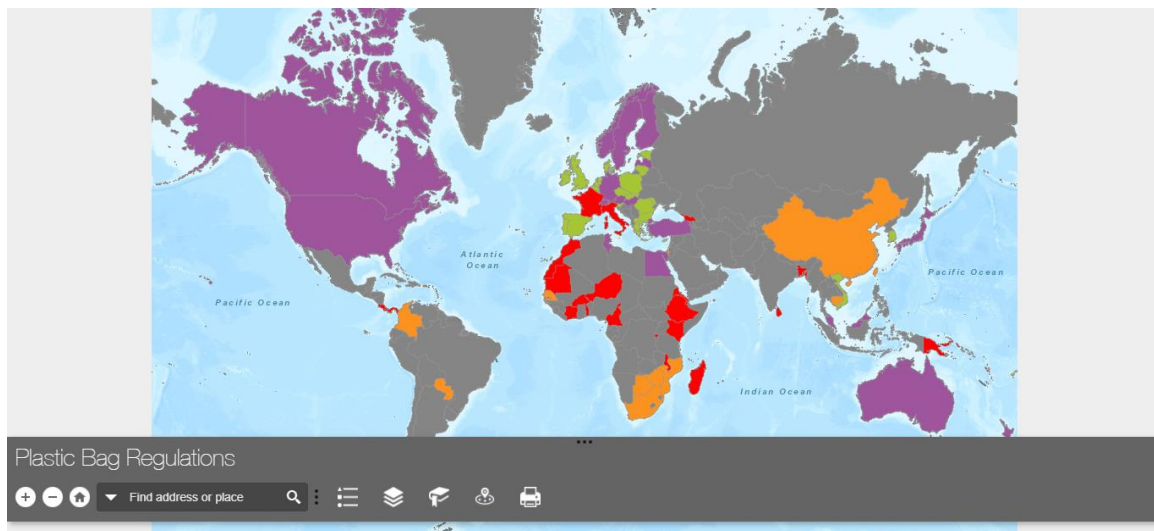

Figure 8: Plastic bag regulations WebApp

This online map can be found at the following URL for those with an ArcGIS account:
<http://harvard-cga.maps.arcgis.com/apps/webappviewer/index.html?id=d1be2b2b034946b1898b9b837b4d594e>

For those without an ArcGIS account, a website was created to allow a more widespread access to this tool. The map can therefore also be found at the following address: <https://chassecatherine5.wixsite.com/plasticbagregulation>

National Initiatives

Many countries have instituted strategies in an effort to curb plastic bag consumption in their nation (Appendix A). Some of these have been successful, whereas others have limited or no visible success. The oldest measure taken at the national level is attributed to Denmark, which has imposed a tax on plastic bags with a holding capacity of at least five liters since 1994. This has helped the country become one of the smallest consumers of LPSBs with a per-capita consumption of only four single-use plastic bags per person per year (Barbieri, 2015). Compared with the EU average of roughly 200 plastic bags per person, this is significantly low. Based on their current population, Denmark consumes 22 929 200 plastic bags annually. This means that 0.08% of the population contributes to approximately only 0.00002% of the annual worldwide consumption of plastic bags.

Since Denmark initiated their tax, more countries have followed suit trying to obtain similar results as Denmark. Over 80 countries are currently subject to some form of reduction strategy (Figure 9). For instance, in 1999, the country of Bhutan attempted to ban plastic bags, however, lack of available alternatives resulted in poor results. The ban was reintroduced in 2005, and this time some alternatives such as cloth bags and biodegradable plastics were put in place. However, plastic bags continue to proliferate, especially in larger urban centers. The Waste Prevention and Management Regulation

was established in 2012 to try to mitigate the issue, but lack of enforcement continues to be a problem (Phuntsho, S., 2013). When it comes to national bans, lack of enforcement and available alternatives often results in very limited success of the regulation. In fact, combining strong enforcement with availability of alternatives seems to increase success of the regulations.

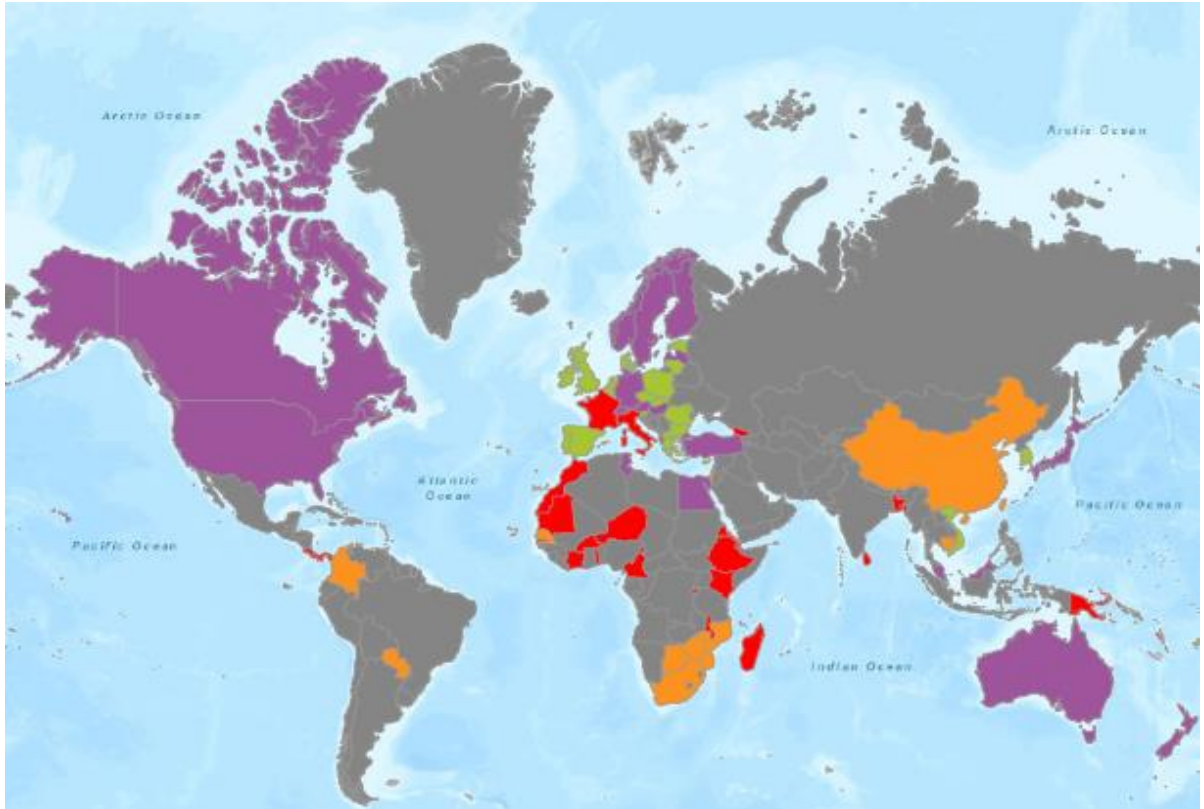

Figure 9. Current national initiatives.

Four main types of initiatives were recognized at the national level. These consist of bans, levies, voluntary actions and hybrid band and levy strategies. Bans are the most frequent with 40.2% of the countries having chosen to apply this particular strategy, whereas a ban combined with a fee is the least frequent initiative at 14.6% (Figure 10). However, when population is taken into consideration, more people are subject to a ban combined with a fee than any other type of initiative and although more countries have

decided to adopt the lone ban approach, they only account for 9% of worldwide population (Figure 11). Unfortunately, there remains half of the world population that is not under any type of national action aimed at reducing consumption of LPSBs.

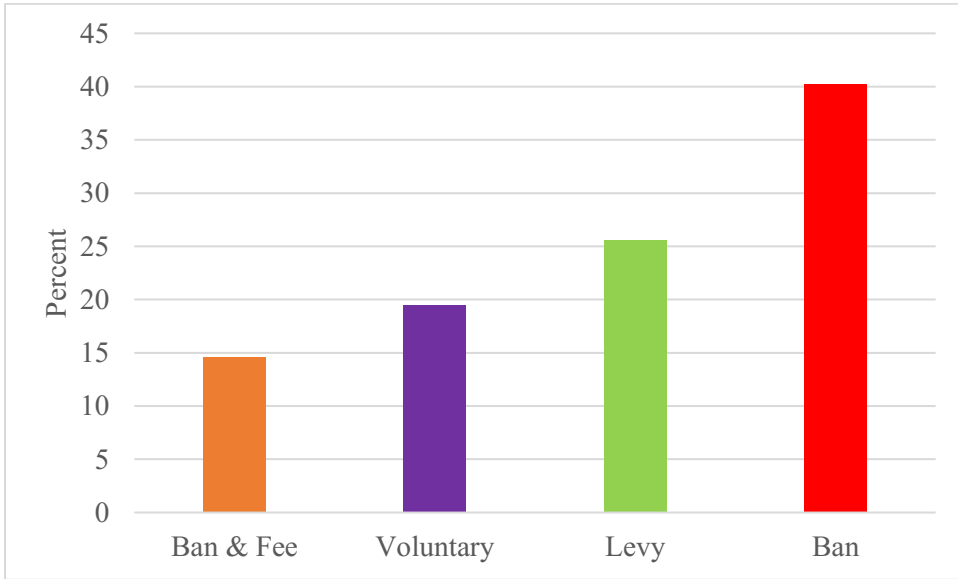

Figure 10. Current popularity in decision-making at the national level

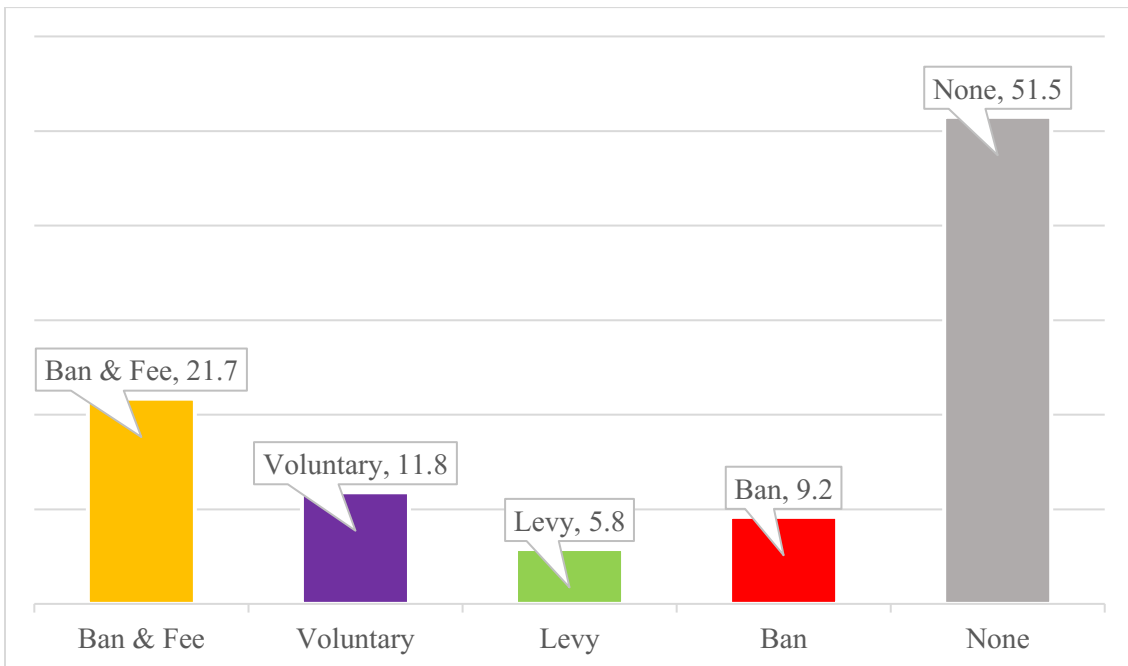

Figure 11. Proportion of the population subject to national initiatives

This popularity of bans has only recently emerged. For the majority of the past 15 years,, levies have been the preferred mode of action (Figure 12). Since the introduction of a levy in Ireland in 2002, the number of countries introducing a similar regulation steadily increased yearly. Since 2015, the number of countries subject to a ban has increased exponentially. In fact, in 2014 only 11 countries were subject to a ban whereas by 2018, 35 countries will have instituted a nationwide ban on LPSBs.

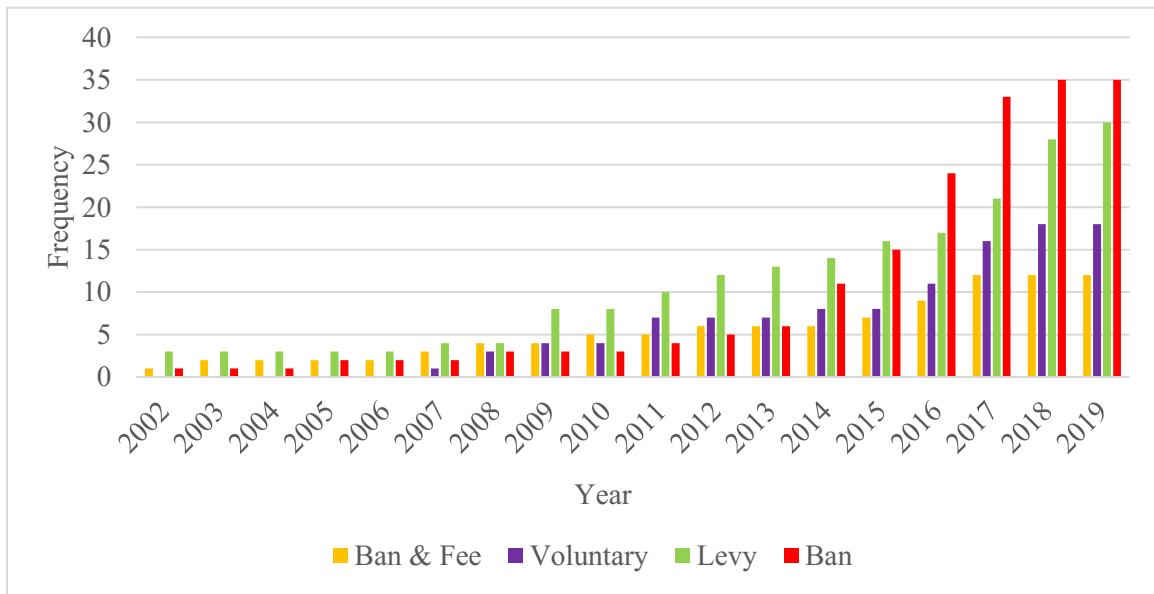

Figure 12. Trends in national decision-making through time

Effectiveness of a Nationwide Ban

There are multiple types of bans being enacted into law at the national level. Some laws only ban certain types of plastic bags whereas others have instituted a complete ban on all types of plastic shopping bags. Partial bans differ in terms of bag composition as well as wall thickness. Some countries, such as Djibouti, Papua New Guinea and the Cook Islands have instituted bans on non-biodegradable plastic bags whereas other countries have concentrated their efforts on bags below a certain wall

thickness, which they consider to be single use. For instance, Georgia has banned plastic bags less than 10 microns thick since September 2017 and will extend the ban to bags below 15 microns thick in 2018 (Menabdishvili, M., 2017) whereas Malawi instituted a ban on plastic bags less than 60 microns in 2015 (Muluzi, A., 2015). France and Monaco, on the other hand, have multiple restrictions. In 2016, both banned plastic bags between 15 and 50 microns thick and have extended the ban to bags below 15 microns thick in 2017. Most countries do not ban these latter types of bags due to the fact that they are often used for hygienic purposes such as protecting certain types of food. France's ban also extends to non-biodegradable and non-compostable plastic bags. Over 40% of the countries that have instituted bans have decided to prohibit all types of plastic bags regardless of composition or wall thickness.

Although bans have been identified as the most frequent type of regulation enacted at the national level, it is reasonable to observe thus far that these regulations have often not met their intended objectives. However, such as observation is provisional as the determination of their effectiveness was greatly limited by the fact that over 50% of countries have only enacted their regulations within the last two years and have not yet released reports on results. Information from countries that have released evidence following the implementation of their ban shows that over 76% of them have not been very successful in doing the intended job. Lack of enforcement, lack of alternatives and opposition from producers and policy makers are often linked to the ineffectiveness of the bans. The Bangladesh ban is one of these regulations that seem not to have been at all successful, because although plastic bags were outlawed in 2002 following massive flooding caused in part by these items which choked the drainage system, plastic bags

continue to be used to date in great quantities. There is also no clear evidence that plastic bag consumption has decreased in the country. Therefore, the ban has not met its objective and cannot be considered a success. Activists have suggested that lack of enforcement as well as the absence of a cost-effective alternative are responsible for the failure to eradicate or even substantially reduce plastics from the marketplace (IRIN, 2011). Cameroon and Burkina Faso have also both had difficulties in successfully implementing their bans on plastic bags less than 60 and 30 microns thick, respectively. In fact, the presence of plastic bags continues to be readily observable throughout these countries.

Many reasons have been suggested for the continuous use of plastic bags. In Cameroon, producers and distributors argued that the transition period given to phase-out the outlawed plastic bags was insufficient, however, they were given over a year between the date of publication of the law and the enactment of the ban. Awareness campaigns and availability of alternatives were also not perceptible, which has also contributed to the ineffectiveness of the ban. Concerning Burkina Faso, a year after the implementation of the ban, it was suggested that lack of awareness and lack of alternatives as well as difficulty in distinguishing between the prohibited and allowed bags resulted in an ineffective measure (Ekoualla, C., 2016).

Only a handful of countries have managed to significantly reduce plastic bag consumption following the enactment of a ban. These include Rwanda, Eritrea and Morocco. Rwanda has been particularly successful in implementing an outright ban on all types of plastic bags. In fact, since the entry into force of this ban, Rwanda has become one of the cleanest countries in the world. Its capital, Kigali, has been named Africa's

cleanest city by the United Nations. The World Travel Guide also classifies Kigali as the third greenest destination in the world (Ekoualla, C., 2016). Reduction in plastic bag use in the country has greatly contributed to these titles. The success of the ban has been attributed to both strong enforcement and assistance – the combination of measures such as plastic bag confiscation at airports and country borders, the tracking down of trafficking networks as well as the distribution of more environmentally friendly alternatives. When it comes to bans, combining them with strong enforcement as well as availability of alternatives seems to increase the success of the regulation.

Effectiveness of a Nationwide Levy

At this writing, 30 countries have instituted some sort of fee on plastic bags. Since Denmark instituted its tax on importers and distributors in 1994, new countries started to implement their own fee on plastic carrier bags every few years, increasing exponentially the number of such initiatives. 50% of the current initiatives have appeared within the last three years and will all be effective by 2019. This exponential growth in the number of levies being applied can be linked to action being taken within Europe following the adoption of the EU Directive 2015/720 in June 2015. The directive requires that all member states take measures to achieve a sustained reduction in the consumption of lightweight plastic bags (less than 50 microns thick) on their territory. The directive also states that:

The measures taken by Member States shall include either or both of the following:

- a) The adoption of measures ensuring that the annual consumption level does not exceed 90 lightweight plastic bags per person by 31 December 2019 and 40 lightweight plastic carrier bags per person by 31 December 2025, or equivalent targets set in weight.

- b) The adoption of instruments ensuring that, by 31 December 2018, lightweight plastic carrier bags are not provided free of charge at the point of sale of goods or products, unless equally effective instruments are implemented. (European Parliament and the Council of the European Union, 2015)

Due to these requirements, many Member States have complied with the directive by instituting a levy on LPSBs. Eleven European countries have introduced levies since 2016, nine of which will be effective in 2018 or 2019. These new regulations mean that Europe constitutes 73% of all worldwide national levies.

As with bans, there exists some variation in the types of levies implemented. Some levies are applied to all bags whereas others only apply to bags of a certain wall thickness (most countries in Europe apply a charge on plastic bags less than 50 microns thick). There is also a wide variation in terms of the decided amount of the levy as well as the persons or organizations to whom the charge applies. For example, some charges apply to importers and/or distributors and/or producers, such as in Vietnam, whereas others apply to consumers at the point of sale, such as in England, Ireland and the Netherlands.

When it comes to charging consumers at the point of sale, plastic bags cost between 0.02USD and 0.56USD depending on the countries (Table 4). Romania and Macedonia charge the least per plastic bag whereas plastic bags in Denmark supermarkets are the most expensive, ranging from 0.32USD to 0.56USD. When the charge is too low, plastic bag consumption does not seem to decrease significantly due to the fact that consumers simply get accustomed to paying the small fee. This was the case in Romania, where an initial fee was instituted at 0.05USD, but later decreased to 0.02USD per bag. The initial fee resulted in a 30% decrease in plastic bag consumption, however, when the fee was

decreased, consumption started to rise once again. In fact, since 2010, the revenue collected from the charge on plastic bags has risen to 9 021 600USD compared to the initial 2 335 360USD collected in the first year of the ban (Brenuic, I., 2015). This suggests that the low fee is serving more as a tax, generating revenue, than a fee designed to meet the goals of decreasing single-use plastic bag consumption while encouraging the use of reusable alternatives.

Table 4. Variation in levy amounts imposed on consumers at the national level

Charge (in USD)	Countries
0.02	Macedonia Romania
0.04	Greece (to be implemented in 2018)
0.05	Fiji Romania
0.06	Hong Kong Spain (for smaller bags – to be implemented in 2018) Slovakia
0.07	England Northern Ireland Scotland Wales
0.08	Greece (to be implemented in 2019)
0.10	Bulgaria Netherlands (average cost decided by retailers) Portugal Slovakia
0.18	Ireland Malta Spain (for larger bags – to be implemented in 2018)
0.26	Ireland
0.30	Netherlands (suggested by the government, but retailers are free to decide what they want to charge)
0.32 – 0.56	Denmark (in supermarkets)

When the charge is set higher, this appears to encourage consumers to opt for more environmentally friendly alternatives such as using reusable bags and decreases most significantly the per capita consumption of single-use plastic bags. It could be argued that Denmark's high fees in supermarkets has greatly contributed to the country's very low number of single-use plastic bags used per person each year. Another example of this phenomenon is Ireland, where from 2002 to 2015, the country has gone from 328 plastic bags consumed per inhabitant annually to only 12 (Figure 13). There was a slight increase in consumption a few years after the levy was introduced, but the government responded to this spike by increasing the levy from 0.18USD to 0.26UD for each bag provided to customers, which helped decrease consumption once again. The levy has not changed since its increase in 2007, however, per capita consumption has remained extremely low, compared to the average European, who uses almost 200 single-use plastic bags annually (Barbiere, 2015).

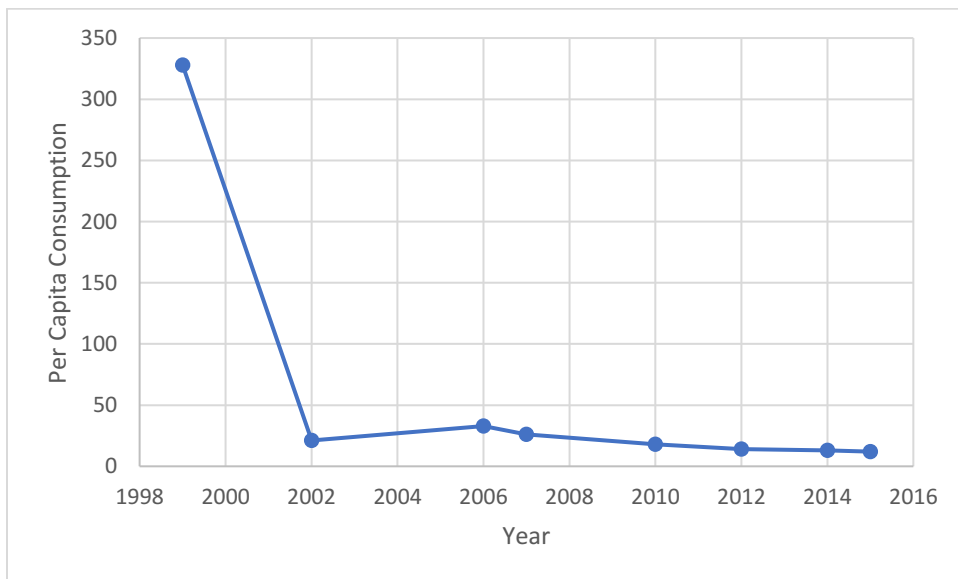

Figure 13. Per capita consumption of plastic bags in Ireland

There is also a significant correlation between the charge imposed on customers and the percent decline after one year of implementation. A linear regression analysis resulted in a p-value of 0.012, which suggests that there is a strong relationship between costs per bags and their reduction (Figure 14). In fact, the higher the charge, the better the chances of decreasing the use of plastic bags. Belgium was not included in this analysis because price per bag was not available.

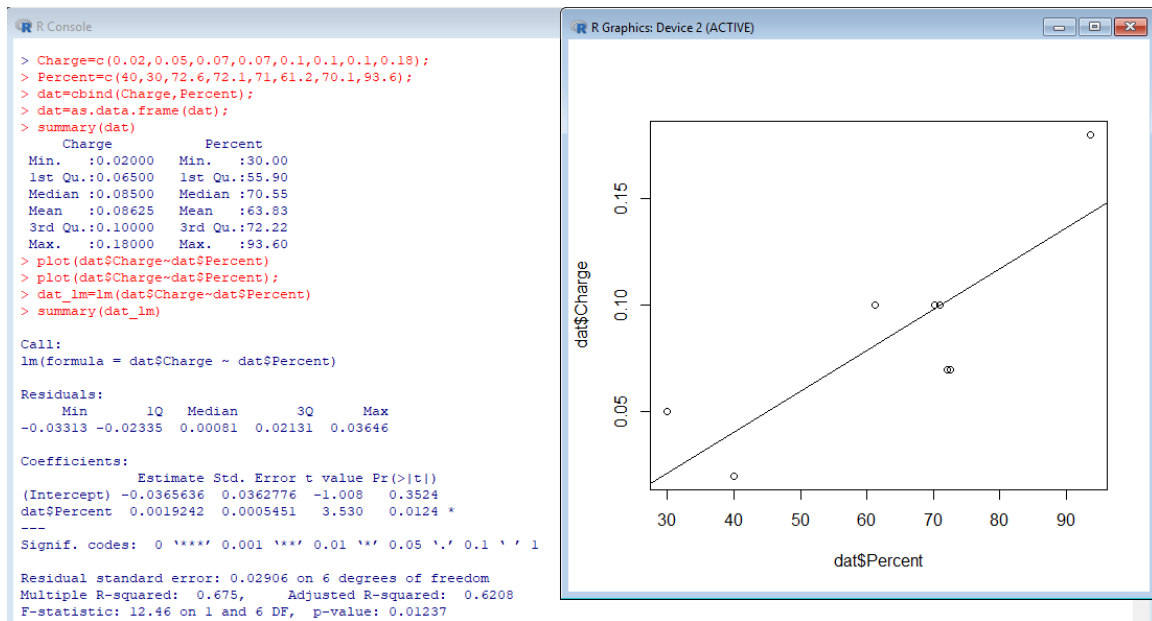

Figure 14. Correlation between the national levy charge and reduction of plastic bags

LPSB consumption is also shown to decrease significantly during the first year of the charge regardless of the amount (Table 5). The lowest reduction percentages are found in the two countries having the lowest fee, i.e. Romania and Macedonia, at 30% and 40% respectively. On the other hand, reduction rates do not vary greatly between countries who have moderate fees. Countries that have instituted a 0.07USD levy or a 0.10USD levy, have relatively the same reduction outcomes at around 60 to 70%. Although the Netherlands have a suggested 0.30USD levy, their reduction has been slightly inferior to England, which only charges 0.07USD per bag. This is likely due to

the 0.30USD levy in the Netherlands only being a suggestion. In fact, shopkeepers are free to fix their price. Therefore, some supermarkets have adhered to the suggestion, but other retailers have not. Retailers are actually charging an average of 0.10USD per plastic bag (Pieters, J., 2017). These averages are therefore consistent with the charges imposed by England, Northern Ireland and Portugal.

Table 5. Change in plastic bag consumption one year after implementation of a national levy

Country	Per capita consumption prior to levy	Per capita consumption one year later	Percent change
Belgium	163	98	-60%
Bulgaria	421	163	-61.2%
England	156	38	-75.6%
Ireland	328	21	-93.6%
Macedonia	-	-	-40%*
Netherlands	177	53	-70.1%
Northern Ireland	165	46	-72.1%
Portugal	466	135	-71%
Romania	327	252	-30%
Average	271	100	-63.8%

*Mudgal, Lyons, Kong, André, Monier & Labouze (2011) Assessment of impacts of options to reduce the use of single-use plastic carrier bags. Bio Intelligence Service. September 11th, 2011, p.125.

Data relating to the reduction of LPSBs after a year in Wales and Scotland was not available. However, the Welsh government has estimated that reduction of all single-use carrier bags has dropped 71% between 2011 and 2014 (Welsh Government, 2016). Although this report also considers reduction in single-use paper bags, it remains similar to the 67% reduction in LPSBs witnessed in Northern Ireland from 2013 to 2016 (Northern Ireland Department of Agriculture, Environment and Rural Affairs, 2017). Scotland has, for its part, reported that consumption of single-use carrier bags in the seven major grocery retailers had fallen 80% in the first year of implementation.

Levies, may also be imposed, as mentioned earlier, on producers, importers and/or distributors. This is the case in Denmark, Belgium, Vietnam and the Maldives. In Denmark and Belgium, however, the tax is transferred to customers to not only reduce plastic bag use in the country, but also stimulate behavioral changes in consumers. Vietnam takes the approach of imposing a 1.78USD per kilo tax on importers and producers. Considering that there are between 100 and 200 plastic bags in a kilo, this equates to 0.0089USD to 0.018USD per plastic bag. Even with this tax, stores are typically still able to provide their customers with free plastic bags which has therefore meant that plastic bags are still heavily used across the country and the initial goal to reduce consumption by 40% has not been reached (Tuoi Tre News, 2017). In the Maldives, on the other hand, a high tax rate on the importation of non-biodegradable plastic bags has resulted in a significant reduction of these bags in the country (Figure 15).

To encourage the use of biodegradable plastic bags, the Maldives Customs Services does not impose a tax for their importation, whereas the importation of non-biodegradable plastic bags is taxed at a rate of 400%. These differentiated tax rates have resulted in a 76% reduction in the importation of non-biodegradable plastic bags from 2012 to 2017, whereas the importation of biodegradable went from 354 532 bags in 2012 to 63 379 193 bags in 2017. Per capita consumption has fallen 79% for non-biodegradable plastic bags and increased dramatically for biodegradable plastic bags. In fact, importation of biodegradable plastic bags in 2012 was equivalent to only 0.9bags per person, whereas in 2017 this went up to 156 bags per person. The consumption of overall single-use plastic bags has fallen 26% from 300.9 bags per person in 2012 to

225.5 bags per person in 2017 with the great majority of these bags being biodegradable. Hence, the high tax rate on non-biodegradable plastic bags has been quite successful in reducing their use. However, this has also resulted in an increased use of biodegradable plastic bags, which are also single-use. These bags may also be problematic when discarded as they may interfere with recycling programs. Therefore, proper education regarding their appropriate disposal would be indispensable.

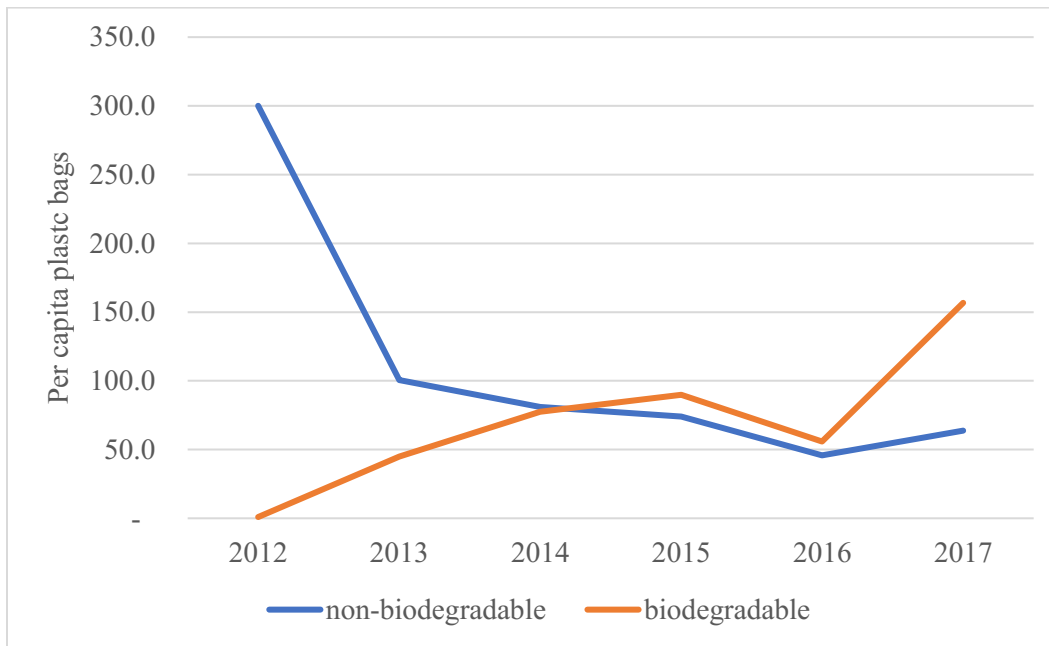

Figure 15. Changes in per capita consumption of plastic bags in the Maldives.

Thus, combining the strategies of charging consumers at the point of sale as well as imposing high tax rates on producer, distributors and importers has proven to be effective in reducing national consumption of conventional LPSBs.

Effectiveness of National Bans Combined with a Levy

Since Taiwan, in 2002, introduced a law which banned plastic bags less than 60 microns thick while also requiring that a fee be imposed on the accepted plastic bags

eleven more countries have instituted similar laws (Table 6). For the most part, bans apply to plastic bags between 20 and 30 microns thick depending on the country. When it comes to the levies, these charges apply to customers at the point of sale in order to change the public's throwaway consumer habits and encourage environmentally-friendly alternatives. Just like for the levy strategy analyzed earlier, there is a variation in the costs of plastic bags. In fact, consumers are charged between 0.007USD and 0.18USD for the thicker plastic bags.

Table 6. Countries having instituted a ban and levy on plastic bags

Country	Ban	Levy (per bag)
Andorra (1 st regulation)	Single-use plastic bags	0.02USD for bags in the food industry
Andorra (2 nd regulation)	Less than 50 microns thick	0.12USD for bags made with more than 80% recycled materials 0.18USD for bags made with less than 80% recycled materials
Botswana	Less than 24 microns thick	Free to decide Typically between 0.035USD and 0.07USD
Cambodia	Less than 25cm wide	0.12USD in supermarkets
China	Less than 25 microns thick	Free to decide
Colombia	Less than 23 microns thick Area inferior to 30cm x 30cm	20COP (0.007USD) in first year 10COP (0.0035USD) increase every year
Israel	Less than 20 microns	0.10USD for bags between 20 and 50 microns thick
Mozambique	Less than 30 microns thick	Not specified
Paraguay	Less than 25 microns thick effective January 2019 Gradually phased-out with levy until then	Small (less than 1000cm ² – min. 15microns) – 0.02USD Medium (between 1000 and 1500 cm ² – min. 18 microns) – 0.03USD Large (between 1500 and 2000 cm ² – min. 20 microns) – 0.04USD Extra-large (more than 2000cm ² – min. 22microns) – 0.05USD
Senegal	Less than 30 microns thick	Not specified

South Africa	Less than 30 microns thick with a permitted 20% latitude, so in practice it became 24 microns or less	0.02USD for bags with small holding capacity (12 liters) 0.04 USD for bars with larger holding capacity (24 liters)
Taiwan	Less than 60 microns thick	Free to decide Typically between 0.03USD and 0.10USD
<i>Zimbabwe</i>	Less than 30 microns thick	0.08USD

For the most part, the ban portion of the regulation has failed for similar reasons to those in the countries that only implement a ban. For instance, in Zimbabwe, retail shops and consumers considered that there was not adequate consultation on the part of stakeholders and the general public. There has therefore been resistance when it comes to the implementation of this regulation. Some shops have smuggled smaller plastic shopping bags from Mozambique and people are gradually resorting back to flimsy plastic bags. In the long run, China has also had issues in implementing its plastic bag regulations. At first, plastic bag consumption fell by 66%, which was considered quite a success. However, nowadays, small shops are flouting the ban and provide free plastic bags whereas larger shops no longer encourage the use of reusable alternatives and the charge has become more of a business than an environmental measure. Mao Da, the founder of Zero Waste Beijing has suggested that after so many years, adjustments are required, as the public has become accustomed to paying for plastic bags and is desensitized to the harmful effects of plastic bags (You, L., 2017).

The levy portion of this measure has helped yield similar results than the lone levy strategy. In fact, just like with the lone levy strategy, countries instituting higher levies have yielded better reduction levels than those with relatively low levies. In Andorra and Colombia, where levies are low, consumption of thicker plastic bags fell by less than 30%: by 28% in Andorra after 2 years of implementation and 27% after 5-months of

implementation in Colombia. In Israel, where the levies are set higher, an 80% reduction in the use of thicker plastic bags was recorded after a year. In South Africa, plastic bag use fell sharply (76%) in the first few months following the implementation of a charge. However, a reduction of the levy portion of the regulation following pressure from the plastic bag manufacturers resulted in a rise in consumption (Dikgang, Leiman & Visser, 2012), such as was the case in Romania following the reduction of their lone levy. The hybrid ban and levy strategy seems to yield similar results to those of a lone levy however, results are more significant than a lone ban. Combining both strategies does have the potential to yield better results than the lone strategies, however, better enforcement and education is needed to ensure the respect of the ban portion of the law.

The Taiwan Environmental Protection Administration [EPA] has also deemed its hybrid plastic bag regulation a success. In fact, only six months after its implementation, plastic bags use fell 80% in the affected retail establishments. However, after some time, plastic bag use rose, but has been maintained at 1.43billion annually. This corresponds to a 58% reduction compared to the annual 3.435billion bags consumed in 2002. Unfortunately, although the affected retailers managed to reduce their distribution, overall plastic bag use has continued to increase in Taiwan. This is likely due to the fact that the 2002 regulation only applies to approximately 20 000 stores. The Taiwan EPA has therefore recently decided to expand restrictions, which would result in 80 000 more stores being affected by the ban and levy (Taiwan Environmental Protection Administration [EPA], 2003; Taiwan EPA, 2017).

Effectiveness of National Voluntary Measures

The remaining countries recognized as taking measures towards reducing the use of plastic bags in their nation have voluntary strategies in place (Table 7). These voluntary measures are either initiated by the retail sector or are led by governments in the form of sustained programs or short-term activities. Some measures consist of instituting a voluntary fee in retail establishments, others have completely banned plastic bags. In some countries, such as Malaysia and Brunei, bans or fees are instituted on certain days of the week only. Other countries have multiple kinds of voluntary measures in place. For instance, in New Zealand, some stores require customers to pay for plastic bags, others encourage the use of reusable alternatives by providing rebates to customers who bring their own bags, and some have taken part in the “Soft Plastic Recycling Program” initiated by the grocer ‘Countdown’ which encourages customers to recycle their single-use plastic bags in specially marked bins.

Table 7. Types of voluntary measures at the national level

Country	Government led	Retailer/ NGO led	Eliminate	Fee	Eliminate & Charge	Awareness/ Bring your own bag
Australia		X	X			
Austria	X			X		
Barbados		X		X		
Brunei	X		X			
Canada		X	X	X		
Egypt	X					X
Finland	X				X	
Germany	X			X		
Hungary		X		X		
Iceland	X			X		
Japan		X		X		
Malaysia	X			X		

New Zealand		X		X		X
Norway		X		X		
Sweden		X		X		X
Switzerland	X			X		
Tunisia	X				X	
Turkey		X		X		X
USA		X	X			X

Although voluntary measures at the retail level have been shown to work individually (IKEA, 2008; World Wildlife Fund, 2009; AEON, 2015), the small scale of these initiatives does not seem to help to reduce overall national consumption (Table 8.). In fact, only small dents are made by each retailer even if they manage to completely eliminate plastic bags in their stores, such as is the case for IKEA in Canada and the USA. In fact, the elimination of plastic bags in these stores contributed to less than 1% annual reduction in Canadian and American national consumption. Even when the largest retailers reduce their distribution, such as Loblaws in Canada and AEON in Japan, no more than 9% overall reduction under voluntary measures is witnessed. Although there are no mandatory national programs in place, national estimates of plastic bag consumption can be found for some countries. For example, Canadians are estimated to use approximately 12 billion plastic bags per year (Suzuki, 2012), whereas Americans are estimated to use approximately 100 billion plastic bags per year (Conserving Now, 2018). These types of estimates were used to determine contribution to national reduction.

Table 8. Results from voluntary initiatives led by the retail industry

Country	Retailer	Type	Results	Contribution to annual national reduction
Canada	IKEA	0.04USD fee at first, followed by a complete elimination	90% reduction in first six months. As of 2009, banned completely	-25,000,000 bags annually Approx. 0.2%
	Loblaw	0.04USD fee	10 billion less bags between 2007 and 2016.	-1,100,000,000 bags annually Approx. 9%
Hungary	Supermarkets	Fee (not specified)	N/A	Although supermarkets charge for plastic bags, Hungary remains one of the top LPSB consumers in Europe
Japan	AEON	Between 0.02USD and 0.04USD	65% reduction between 2010 and 2016	-2,770,580,000 bags in 2016 Approx. 9%
Latvia	Supermarkets	Fee (not specified)	N/A	Although supermarkets charge for plastic bags, Latvia remains one of the top LPSB consumers in Europe
New Zealand	The Warehouse	0.07USD fee	67% reduction since 2009	-3,081,617 on average annually Approx. 0.2%
	New World	Reusable bag rebate	10-20% reduction in 2017	N/A
	Soft Plastic Program	Recycling program	25 million bags recycled in 2016	Approx. 1.5% of all plastic bags used in the country
Norway	Supermarkets	0.12USD fee	N/A	Norwegians still use an average of 190 plastic bags annually
Sweden	Coop	Eliminate & Charge	100% reduction of oil-based plastic bags, but continue to provide other types of single-use plastic bags	Although oil-based plastic bags are no longer provided, customers use an average of 2.2 new single-use plastic bags a week

USA	Wholefoods	Eliminate	No longer provide plastic bags	-150,000,000 bags annually Approx. 0.15%
	IKEA	Eliminate	No longer provide plastic bags	-70,000,000 bags annually Approx. 0.07%
	Kroger	Offer reusable bags and encourage their use. Better bagging practices	1 billion plastic bags saved since 2007	-125,000,000 bags annually Approx. 0.13%
	Sea World	Eliminate	No longer provide plastic bags	-4,000,000 bags annually Approx. 0.004%
	Target	0.05USD discount for each reusable bag used	475 million plastic bags saved since November 2009	-67,857,143 Approx. 0.07%

When voluntary initiatives are led by governmental entities, a more significant reduction in national reduction can be seen compared to above (Table 9). However, most initiatives of this type have surfaced in 2016 or later. Therefore, mostly short-term data is available. Malaysia and Brunei have the oldest initiatives in this category. Both have similar initiatives, which consist of discouraging the use of plastic bags on certain days. These have been shown to work on the allocated days, but this does not help in changing consumer behavior on other days of the week. In the case of the other countries, it is still too early to tell if there has been a reduction due to lack of data. However, it has been shown in Austria and Germany that the voluntary agreements have reduced consumption, but with a 15% and 33% reduction, respectively, after a year, this suggests that reduction is not as significant as when a mandatory levy is imposed.

Table 9. Results from voluntary initiatives led by governmental entities

Country	Type	Results	National reduction
Austria	Free to decide	Reduction of nearly 89 million plastic bags in first year (in 2016)	15% reduction. Per capita consumption decreased to 30.
Brunei	No plastic bag weekend	See a reduction on days of campaign, but not on weekdays	Plastic bag habits yet to change fully
Egypt	Encourage use of reusables	Launched in late 2017	Too early to tell
Finland	Ban & Fee	Report to come out in 2019	Too early to tell
Germany	Levy	2 billion plastic bags less in first year (in 2016)	Per capita consumption decreased by 33%.
Iceland	Levy	No data available	Too early to tell
Malaysia	Levy on Saturdays	Some supermarkets see a reduction on that day, others don't	Still use an average of 300 plastic bags a year in supermarkets and hypermarkets
Tunisia	Ban & Fee	Launched in March 2017	Too early to tell

Regional Initiatives

Many regions around the world are currently fighting overconsumption of LPSBs (Appendix B). At least 100 regions within 21 countries have taken it upon themselves to reduce plastic bags in their area through various initiatives (Figure 16).

Five main initiatives were recognized at the regional levels. Just like at the national level, some areas have bans, levies, voluntary measure or a hybrid ban and levy strategy. However, a fifth initiative was recognized in the United States: recycling programs which aim to encourage customers to bring back their bags for recycling at certain retail establishments. These recycling programs are either required by law or are voluntary.

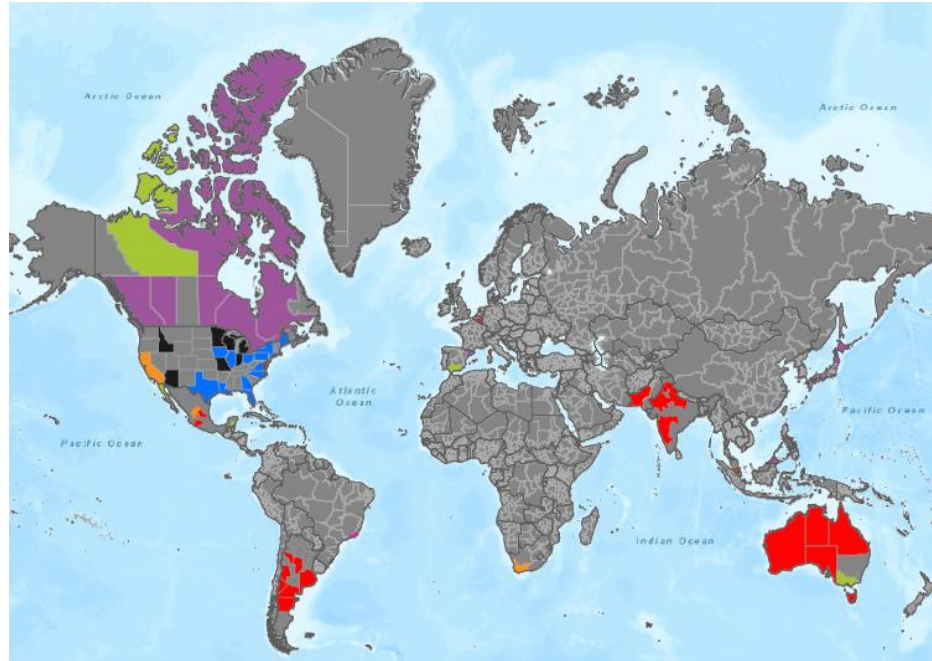

Legend
 None Ban Voluntary Levy Ban & Fee Recycling Ordinance Ban

Figure 16. Current regional initiatives

Just like at the national level, bans are the most frequent measures taken, at 43.5%, whereas bans combined with a levy are the least frequent at 4%. Bans have gradually increased through time whereas voluntary measures spiked between 2008 and 2010 and have since then stayed stable, due to many prefectures in Japan and provinces in Canada instituting governmentally led or retailer led voluntary programs (Figure 17). When population is taken into consideration within these regions, the trend changes slightly. In fact, bans remain the most popular measure, however, the second most popular becomes recycling programs due to high populations in the United States, and the least popular becomes levies (Figure 18). The state of Maine led the way in terms of regional initiatives. Since 1991, they require all stores that provide plastic bags to locate inside their stores or within 20 feet of the main entrance, a receptacle for collecting any used plastic bags, which will then be recycled.

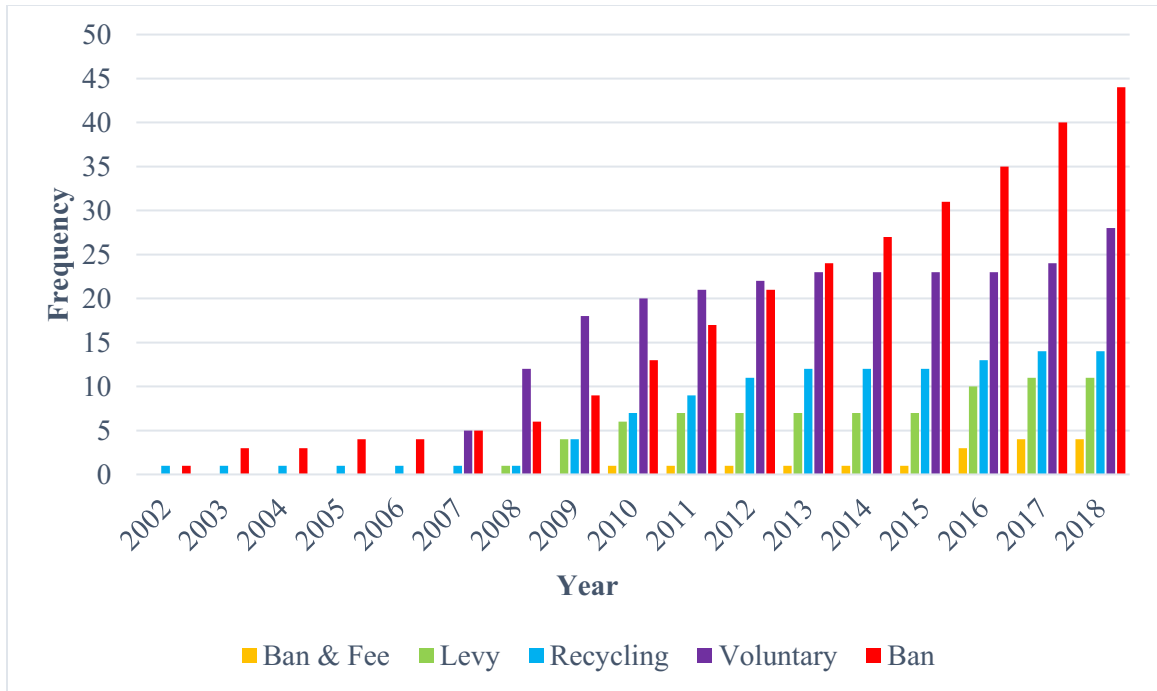

Figure 17. Trend in regional decision-making through time

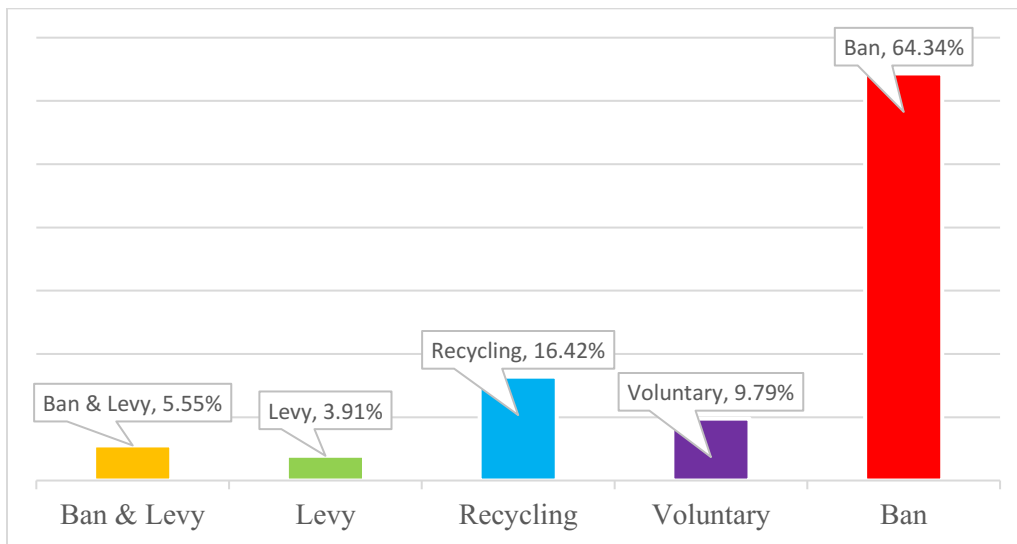

Figure 18. Distribution of current regional initiatives based on regional population

Effectiveness of a Regional Ban

Just like at the national level, there are multiple types of bans enacted into law at the regional level. These regulations range from a few partial bans on bags with a certain

wall thickness, to bans on non-biodegradable plastic bags and total bans. LPSBs banned based on wall thickness are usually bags with a thickness between 30 and 50 microns. Most regulations however consist of complete bans or bans on non-biodegradable plastic bags.

The first region to ban plastic bags completely was the island of Corsica, France in 2003. The ban was enacted through a referendum following a four-year awareness campaign to reduce the use of plastic bags on the island (Orru, Boyer and Jaraudias, 2005). The ban has been deemed successful with plastic bag consumption decreasing 100% in supermarkets in only a year resulting in an overall 80% decrease throughout all stores on the island (Briet, S., 2004). Other regions to have completely banned plastic bags include Rajasthan, India; Yap, Micronesia; Uttar Pradesh, India; Karnataka, India; Punjab, India; Uttarakhand, India; and Balochistan, Pakistan. These bans have not been shown to be as successful as in Corsica. In Rajasthan, for example, the ban has only been partly successful. Most large establishments have stopped distributing plastic bags to their customers but smaller vendors have not. A study by the Central Pollution Control Board has suggested that despite the ban on plastic bags, LPSB use in the Rajasthan capital of Jaipur has remained quite high compared to other metro cities with plastic bag bans but remains lower than other state capitals without bans (The Times of Jaipur, 2014). Other Indian states with complete bans also seem to be less successful in reducing their plastic bag use. In fact, although these states have complete bans, plastic bag waste continue to litter their streets and some vendors within these states have started smuggling hundreds of tonnes of plastic bags in their stores every month (The Tribune India, 2017). In Uttar Pradesh, which banned plastic bags in 2015, use continues to be

high as authorities have yet to enforce the ban (Rajput, V., 2017). Yap and Balochistan have also had difficulty enforcing their ban due to lack of alternatives as well as opposition from manufacturers and consumers (Mir, R., 2018).

When it comes to partial bans, lack of enforcement and alternatives have also resulted in less successful implementation of the regulations. This has been the case for regions such as Mendoza, Argentina; Mayotte, France (Les Naturalistes de Mayotte, 2014); Cordoba, Argentina; Islamabad Capital Territory, Pakistan (Anwar, S., 2015); Maharashtra, India (Hussai, S., 2017). However, other regions with partial bans have been more successful. For instance, in Goa, India, plastic bags with a wall thickness below 40 microns were first banned in 2002, this resulted in an increased use of thicker bags and therefore the ban was extended in 2017 to plastic bags with wall thickness less than 50 microns and to an expected complete ban by late 2018 (The New Indian Express, 2017). This gradual extension of the ban suggests that although banning thinner bags is successful in reducing these types of bags, it can also result in an increased use of thicker plastic bags. Therefore, consumer behavior did not seem to change relative to plastic consumption in result to a partial ban.

Two regions in Belgium have also been quite successful in implementing a ban. Plastic bags less than 50 microns thick are banned in both Brussels and Wallonia. In Brussels, a few months after the implementation of the ban was enacted, an inspection was made by the Environmental Administration to ensure compliance and they found that the majority of retailers were complying with the new legislation (Bruxelles Environnement, 2018). The partial ban has also been successful in Wallonia, where large retailers have stopped distributing these bags completely since December 2016. Smaller

retailers continue to distribute plastic bags due to a grace period which allows these retailers to distribute LPSBs until December 2017 (Corroenne, O., 2017).

Other partial bans have been implemented in most states of Australia (Figure 19). In fact, through these partial bans, Australia has almost reached a nationwide ban on plastic bags less than 35 microns thick.

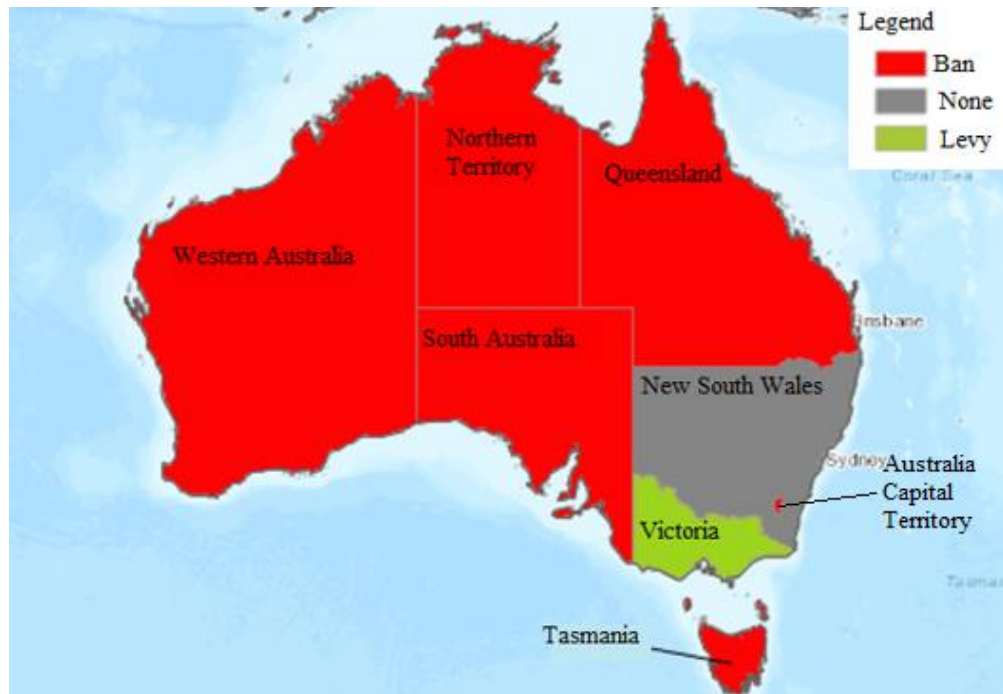

Figure 19. Regional initiatives in Australia

The bans in the states of Queensland and Western Australia will become effective in July 2018 whereas Victoria is the latest state in Australia to have announced a partial ban. In fact, although the state only had a trial levy in 2008, it was announced in October 2017 that the government will be banning single-use plastic bags, but the date of implementation is yet to be announced. Once this ban comes into effect, New South Wales will be the only state without any type of restriction on single-use plastic bags which will result in 68% of the Australian population being under a plastic bag ban. When it comes to the states which have had a ban for a few years (i.e. South Australia,

Northern Territory, Tasmania and the Australian Capital Territory), results have been mixed. South Australia was the first state to ban plastic bags less than 35 microns thick back in 2009. A review conducted two years after the ban was implemented concluded that the ban provided significant benefit to the community. In fact, over 90% of retailers were shown to comply with the ban (Sharp & Wheeler, 2012). Consumer behavior has also change, with almost 90% of people bringing reusable bags when shopping on most occasions compared to 60% before the ban (Zero Waste Australia, 2011). In the Australian Capital Territory and Tasmania, the ban was successful in decreasing the consumption of lightweight plastic bags (less than 35 microns), however, consumption of thicker plastic bags was shown to have increased significantly (Hayne, J., 2017; Waste Management Review, 2017). Consumer behavior relative to the overall negative impacts of plastic bags had not fully changed. Finally, in the Northern Territory, the ban has not been deemed a success. In fact, for five consecutive years, the number of plastic bags has continuously increased. Therefore, the regulation has failed in its intent to reduce unwanted litter (Keep Australia Beautiful, 2017).

Effectiveness of a Regional Levy

Few regions have opted to impose a mandatory charge on plastic bags. In fact, only eleven regions were found to have implemented such a strategy, at some point in the past ten years. The regulations vary from a trial tax of 4-weeks in Victoria, Australia to charges on all plastic bags throughout the region as well as charges on certain days of the week only, such as in Penang and Selangor, Malaysia. Although the methods differ from region to region, the amount of the charge is quite consistent (Table 10). Most regions

have a mandatory fee between 0.05USD and 0.08USD. The Northwest Territories in Canada have the highest regional fee at 0.20USD. In Catalonia, Spain, there is no maximum or minimum amount: business owners are free to charge what they consider to be most appropriate. In both regions of Mexico where a mandatory levy is imposed, the specific amount of the levy was not specified.

Table 10. Variation in levy amounts imposed on consumers at the regional level

Charge (in USD)	Regions
0.05	Azores (Portugal) District of Columbia (USA) Penang (Malaysia) Selangor (Malaysia)
0.06	Andalucia (Spain) Cantabria (Spain)
0.08	Victoria (Australia)
0.20	Northwest Territories (Canada)
Free to decide	Catalonia (Spain)
Not Specified	Baja California (Mexico) Quintana Roo (Mexico)

Unfortunately, reports and data were not available for all regions. However, results from the Northwest Territories, the District of Columbia, Victoria, and the Azores suggest that a regional levy has similar effects to a national levy. In fact, in its four-week trial, the state of Victoria reduced plastic bag consumption by 79%. In the Northwest Territories and the District of Columbia, plastic bag consumption fell by over 80% in the first year and has increased slightly over time since then, however, reduction has continued to be quite significant, with the least annual reduction being set at 72.8% in the Northwest Territories (Figure 20).

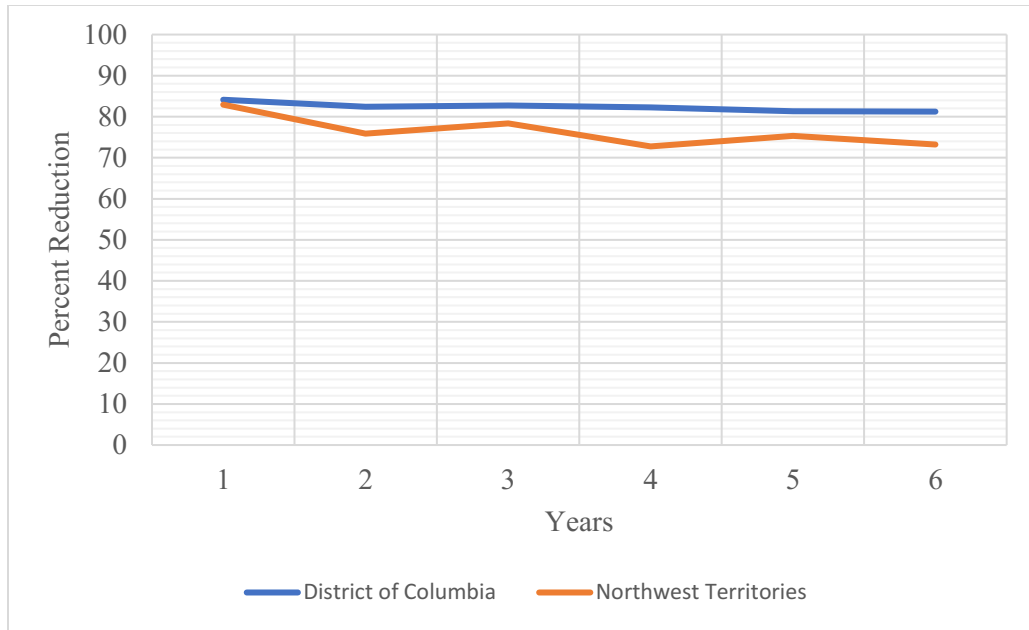

Figure 20. Plastic bag reduction in the Northwest Territories and District of Columbia

In the nine months following the entry into force of a plastic bag fee in large commercial areas of the Azores, 12.6 million plastic bags were saved (Governo dos Açores, 2017). This equates to consumers reducing their plastic bag use in large commercial areas by a little over 50 bags per person in the nine-month period. The reduction is expected to have increased in 2017 due to the fee being expanded to other retail areas in April 2017.

Effectiveness of Regional Bans Combined with a Levy

Only four regions have opted for the combined ban and levy option in order to reduce LPSB consumption in their area. These are the Western Cape in South Africa, Zacatecas in Mexico, as well as the state of California and the territory of Puerto Rico in the United States. All these initiatives, with the exception of Zacatecas, took effect in 2016 or later. In fact, although South Africa has a ban and levy on LPSBs since 2003,

the provincial government of the Western Cape passed a motion in October 2017 which strengthens the national requirements. Plastic bags in the province now need to be 100% recyclable as well as made with 100% recycled-materials and must be biodegradable. The motion also stated that a provincial levy be instituted on these bags. Unfortunately, data is seriously lacking to determine the effectiveness of this strategy at the regional level.

Effectiveness of Regional Voluntary Measures

Many voluntary initiatives have surfaced throughout the years. These initiatives are mostly concentrated in Canada and Japan where agreements between governments and the retail sector have aimed to reduce plastic bag consumption through various methods such as awareness campaigns, charges on plastic bags and reduction incentives.

Unfortunately, no data was found concerning Japan. However, data was available for Canada where six provinces took it upon themselves to reduce plastic bags through voluntary measures between 2007 and 2010 (Figure 21).



Figure 21. Regional initiatives in Canada

In 2007, Ontario became the first province to take action by committing to reduce plastic bags by 50% in five years through a strong framework based on the 3R's strategy led by the Ontario Plastic Bag Task Group which was led by major stakeholders. Following their lead, the major stakeholders in Quebec adopted the "Voluntary Code of Best Practices for the Use of Shopping Bags" which aimed to reduce single-use plastic bags by 50% between 2008 and 2012, through various measures such as implementing a charge on these items. In 2008, 2009, and 2010, British Columbia, Alberta and Manitoba, respectively, also pledged to reduce single-use plastic bags by half in five years through various measures such as encouraging the 3R's strategy, incentivizing the use of reusable bags, efficient bagging practices as well as facilitating access to more environmentally-friendly alternatives. Results varied depending on the province (Figure 22). Not all provinces achieved their 50% reduction target, however, in all these provinces, plastic bag consumption did decrease. Alberta achieved the least reduction at only 28.41% difference after five years, whereas Nunavut achieved the most at 74% after five years. The provinces of Ontario and Quebec reached their 50% target ahead of schedule, after only three years. These show that voluntary initiatives at the regional level have the potential for success.

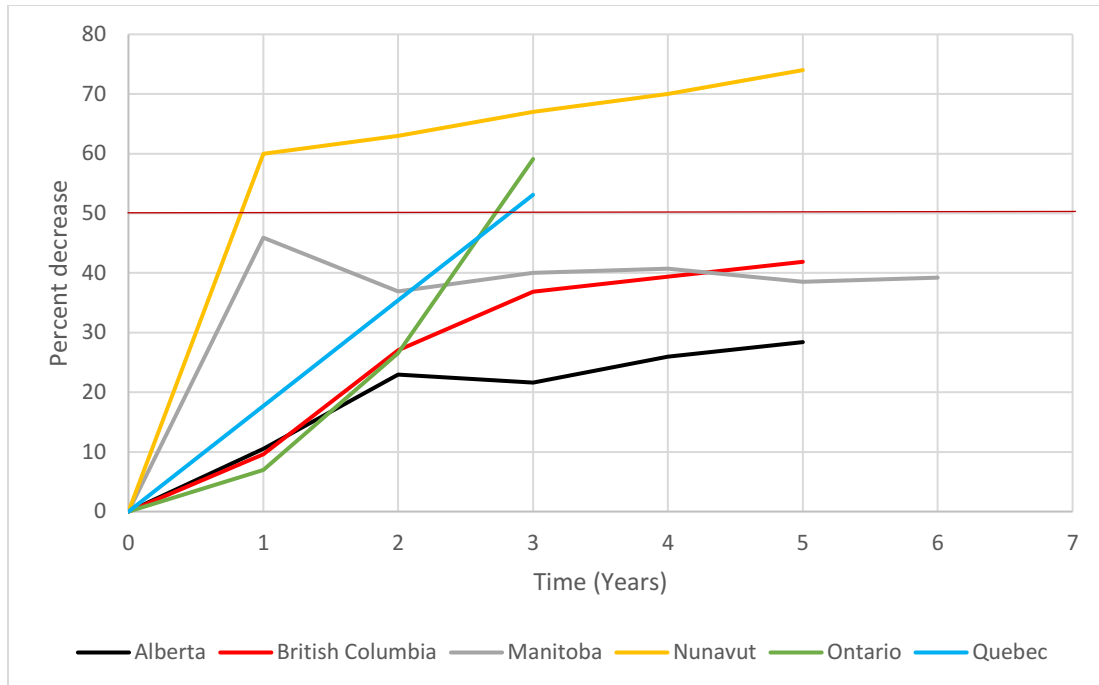

Figure 22. Reduction following voluntary initiatives in Canadian provinces (red line represents target set by provinces)

Catalonia and Bali are two other regions which have reduced plastic bag consumption through voluntary measures. Following the implementation of an agreement between the Waste Agency of Catalonia and various stakeholders, which consisted of reducing the consumption of plastic bags by 20% by 2010 and 50% by 2012, per capita consumption of single-use plastic fell 52% by 2012 (Gallo, F., 2016). In Bali, a campaign initiated by teenagers convinced the government to say no to plastic bags by 2018. Through persistence, the “Bye Bye Plastic Bag” campaign performed beach clean-ups, school presentations, and awareness campaigns throughout the island. The campaign even reached the airport, where no plastic bag is delivered free of charge thanks to the campaign. More recently, the “Bye Bye Plastic Bag” initiative launched the One Island One Voice campaign which highlights efforts of plastic bag free shops, restaurants, hotels and other retailers on the island.

Effectiveness of Regional Recycling Programs

Most initiatives taking place in the United States consist of recycling programs (Figure 23). For the most part, plastic bags are not accepted in curbside recycling programs due to the fact that they clog recycling machines which costs a lot of time and money to the recycling companies. Therefore, statewide recycling programs have emerged in the United States, mostly in the eastern region, to encourage citizens to recycle plastic bags in appropriate locations. Some of these measures are required by law or led by governmental authorities whereas others are voluntary initiatives initiated by retailers and NGOs.

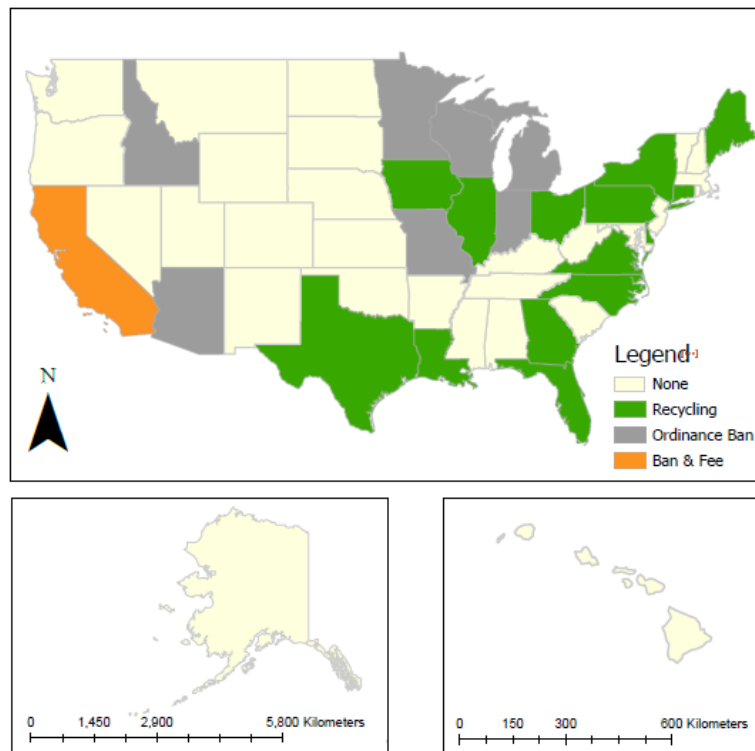

Figure 23. Statewide initiatives in the United States

Maine was the first state in 1991 to require all stores which offer plastic bags to their customers to provide inside their store, or within 20 feet from the main entrance, a receptacle for collecting any used plastic bags to encourage their recycling. It took years

before similar programs emerged in neighboring states. In fact, it wasn't before 2009 that New York, Delaware and Ohio became the next states to initiate recycling programs. New York and Delaware require that stores over a certain retail area provide in-store plastic bag recycling as well as label their plastic bags in a manner that encourages their recycling. Ohio on the other hand provided plastic recycling bins to retailers through a voluntary initiative by the Ohio Grocers Foundation and the Ohio Department of Natural Resources. Since then, ten other states have instituted plastic bag recycling programs. Governments, NGOs and retail associations in Florida, Georgia, Louisiana, North Carolina, Pennsylvania, Texas and Virginia have recently joined the "A bag's life" initiative which identifies hundreds of locations throughout these states where plastic bags can be returned for recycling.

These measures only encourage collecting for recycling, but do not incentivize consumers to reduce plastic bag use. They help reduce, somewhat slightly, the negative environmental impacts of these bags and may not affect consumer behavior significantly. In New York State alone, although there is a recycling program in place, 23 billion plastic bags are used annually across the state and only a very few are recycled. In Delaware, per capita recycling of plastic bags fell by 22% between 2014 and 2016, going from 253 tons of plastic bags recycled in 2014 to 201 tons in 2016. Considering that an average single-use plastic bag weighs 5g, this corresponds to 49 bags per person in 2014 and 38 bags per person in 2016. On average, a person in the United States uses 500 single-use plastic bags annually. By applying this average to the State of Delaware, only 7.6% of plastic bags were recycled in 2016.

Local Initiatives

Over 300 cities around the world have taken it upon themselves to reduce plastic bag consumption in their city limits (Appendix 3). A great majority of these initiatives are taking place in the United States, North America and in coastal cities (Figure 24). Just like at the national level, four main strategies were identified: bans, levies, combined ban and levy, as well as voluntary initiatives. Bans are once again the most frequently chosen initiative at 164 locations worldwide, whereas a ban combined with a levy is the second most frequent at 124 locations worldwide (Figure 25). Before the state of California implemented its combined ban and levy regulation in 2016, over 90 cities and counties had already implemented their own hybrid ban and levy regulations within the state, suggesting that local trends incited the state to take action. Bans are more widely dispersed, occurring on all continents (except Antarctica).



Figure 24. Worldwide local plastic bag regulations

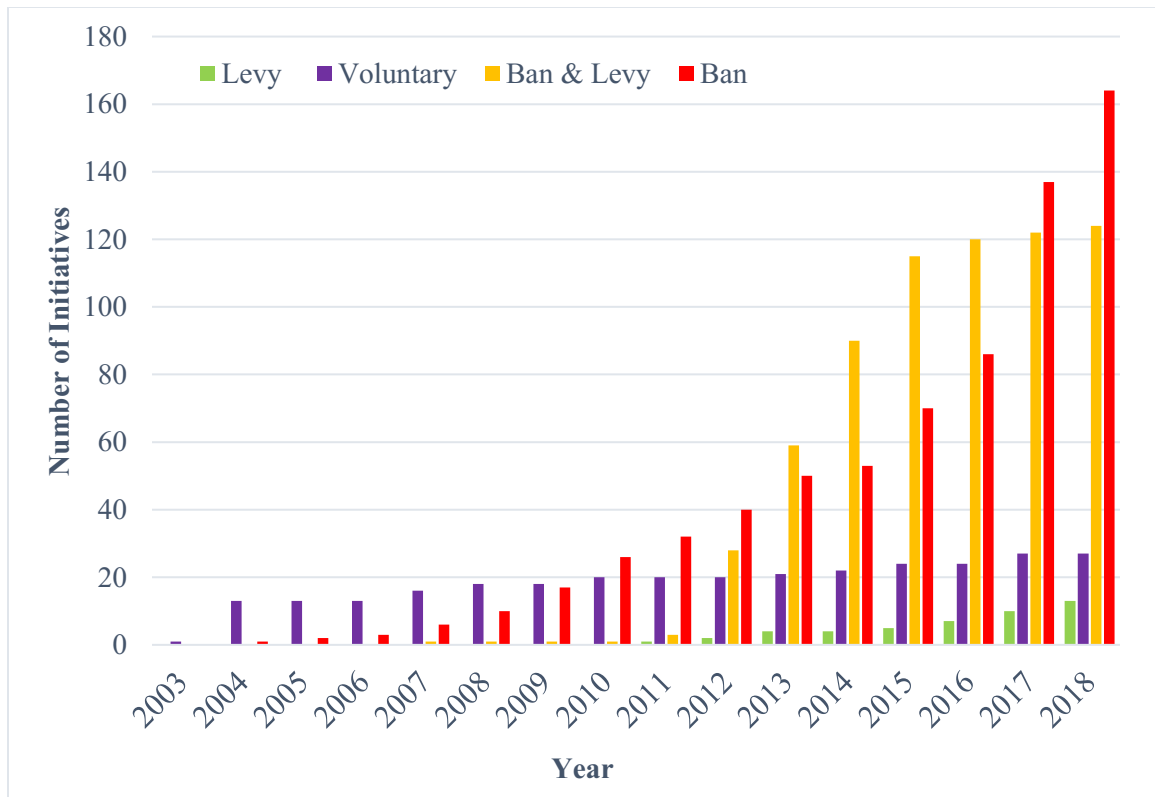

Figure 25. Trend in local decision-making through time

New bans have emerged every year since 2004, but have increased dramatically since 2016. Combined bans and levies spiked between 2012 and 2015 when many Californian cities and counties enacted these types of regulations. Voluntary initiatives have been quite stable since the early 2000s whereas the lone levy strategy has only recently emerged, and remains quite rare.

Effectiveness of a Local Ban

Bans were the most popular strategy between 2010 and 2012 and have recently retaken this position by surpassing the hybrid ban and levy strategy which was the most popular between 2013 and 2016. Just like at the national and regional level, some bans are applied on all types of plastic bags whereas others apply to bags under a certain wall

thickness or to bags made with non-biodegradable materials. Most cities have opted for a partial ban which apply to bags with a wall thickness inferior to 38 to 100 microns, depending on the city. However, most laws apply to bags with a wall thickness of less than 50 to 100 microns. Over 50 cities have opted for a total ban, only providing paper or reusable alternatives made of cloth or other non-polyethylene materials

In many cases, cities have been successful at implementing their laws. In fact, in most of these cases, at least 90% of businesses to which the laws apply have complied with the cities regulations. However, when it comes to partial bans, plastic bags continue to be used in some businesses. In fact, plastic bags with a wall thickness superior to that of a single-use plastic bags are considered reusable and therefore may be provided to customers. Therefore, plastic bags continue to be used in some places due to this loophole. To the extent that these bags continue to be a source of litter, this defeats the purpose of the ban as well as undermines efforts to educate consumers on the harmful impacts of plastic bags. However, the thicker sized bags may be less likely to be discarded thoughtlessly and more likely to be reused.

The city of Brossard in Quebec, Canada has successfully banned plastic bags less than 100 microns thick since September 2016. In fact, ten months following the enactment of the ban 96% of businesses had conformed with the regulation (Corriveau, J., 2017). In most cases, the non-conformity is due to improper interpretation of the law. For example, some businesses were providing paper bags which were not 100% recyclable as is demanded by the law. The city is also an example where plastic bags continue to be distributed due to the definition of a reusable bag, which includes plastic bags with a wall thickness greater than 100 microns. However, these types of bags are not

provided as often as their thinner counterparts and many customers have become accustomed to bringing their own bags or leaving the store without any bag whatsoever. Other cities in Canada which have successfully banned plastic bags include, but are not limited to: Leaf Rapids, Manitoba; Huntingdon, Quebec; Thompson, Ontario; Wood Buffalo, Manitoba; and Fogo Island, Newfoundland & Labrador.

Many cities in the United States have also successfully gotten rid of plastic bags. In Portland, OR, a ban took effect in 2011 which resulted in a reduction of 100 million plastic bags within six months (Equinox Center, 2013). This equates to roughly 168 plastic bags per person within this time frame. In Austin, TX, the ban on plastic bags less than 100 microns thick resulted in a 75% annual reduction in these bags (Waters, A., 2015). This is equivalent to over 197 million plastic bags saved annually, roughly 216 bags per person in the city. Massachusetts has more local bans than any other state in the United States, excluding California's hybrid ordinances. These include cities and towns such as Framingham, Truro, Chatham, Marblehead, Salem and Manchester. Most bans in this state have been enacted in the past year. By the end of 2018, at least 2 million people in the state will be under a plastic bag ban, including the population of Cambridge and Boston, which will be under a hybrid ban and fee law. This equates to a little under 30% of the state population, saving millions of plastic bags annually statewide. Hawaii is another example of how local ordinances can have a statewide impact. Although it does not have the most ordinances, its four most populated counties have implemented plastic bag bans, which has resulted in a de-facto statewide ban. In fact, the counties of Hawaii, Kauai and Maui all have lone bans whereas the county of Honolulu has a hybrid ban and

fee regulation. These have all been successful. However, thicker plastic bags continue to be used in some counties due to their partial ban status.

Other cities that have been successful include, but are not limited to: Westport, CT; Evanston, IL; Edmonds, WA; Mamaroneck, NY; Larchmont, NY; East Hampton, NY; York, ME; Chestertown, MD

Effectiveness of a Local Levy

Twelve cities in the United States have implemented a levy on plastic bags at checkouts. Two of these regulations as well as a levy in Swakopmund, Namibia, are expected to take effect in early 2018. Most cities impose a 0.05USD fee on plastic bags. However, in Boulder City and Breckenridge, Colorado, the charge is set at 0.10USD per plastic bag. In Brownsville, Texas, there was a 1.00USD per-transaction fee from 2011 to 2016, but following a lawsuit from the Texas Attorney General claiming that the environmental fee was an illegal sales tax, the fee was scrapped. The city has instead decided to ban plastic bags less than 100 microns thick in April 2017. Although the fee is quite consistent throughout cities, there is variation in the types of bags to which it is applied (Table 11). Some cities only apply the charge to plastic bags below a certain wall thickness whereas others apply the fee on all single-use carryout bags.

Table 11. Variation in levies at the local level

City	Charge (in USD)	Type of bags
Boulder, CO	0.10	Plastic bags less than 57 microns thick
Breckenridge, CO	0.10	Plastic bags less than 57 microns thick
Brownsville, TX	1.00 per-transaction	All
Ellensburg, WA	0.05	Plastic bags less than 57 microns thick
Falmouth, ME	0.05	Plastic bags less than 100 microns thick
Long Beach, NY	0.05	All
Montgomery, MD	0.05	All
Portland, ME	0.05	Plastic bags less than 57 microns thick
South Portland, ME	0.05	Plastic bags less than 57 microns thick
Suffolk County, NY	0.05	All
Teaneck, NJ	0.05	Plastic bags less than 76 microns thick
Topsham, ME	0.05	Plastic bags less than 100 microns thick

The cities of Fairbanks, AK and Dallas, TX have also attempted to charge for plastic bags at checkouts. Both fees were scrapped only a few months after their implementation due to community opposition.

When it comes to actual effectiveness of the regulation, not all cities have monitored the fee's progress. In Portland, South Portland and Falmouth, stores are required to keep complete and accurate records of single-use plastic bags sold to customers, however there is no overall reporting planned by these cities. In Topsham, Teaneck and Long Beach, the plastic bag fees have only been in place since 2017, therefore, data is yet to be available.

Montgomery, Breckenridge and Boulder City, for their part, have all reported similar results (Boulder Daily Camera, 2016; Kraut, A., 2016; McLaughlin, M. & Halstead, J., 2016). In fact, in all three cities, plastic bag consumption fell between 40% and 70% after one year, but has since stayed stable. This suggests that, just like at the national and regional levels, the initial shock of the levy reduces consumption significantly, however, customers get accustomed to the fee and continue to use the

single-use bags although at a smaller frequency than before the law came into place. In Montgomery, for example, plastic bag consumption decreased to 57 804 817 after one year to 62 493 270 in 2015 (Kraut, A., 2016), equivalent to a 7.5% increase between 2012 and 2015. This equates to a per capita consumption increase of 4.3% between 2012 and 2015.

Effectiveness of a Local Ban Combined with a Levy

Prior to the statewide ordinance which took effect in 2016, many cities in California had already implemented their own regulations, most of which consisted of a hybrid ban and fee strategy (Figure 26). In fact, this strategy was mostly used on the western coast of the United States, whereas on the eastern coast most regulations consist of bans only. This may suggest that cities are influenced by neighboring communities and enact similar laws. These ban and fee regulations consist of bans on plastic bags combined with a fee on paper, reusable, and thicker plastic bags. The ban applies to plastic bags with a wall thickness inferior to 57 or 100 microns, with a few total bans, whereas the fee ranges between 0.10USD or 0.25USD.

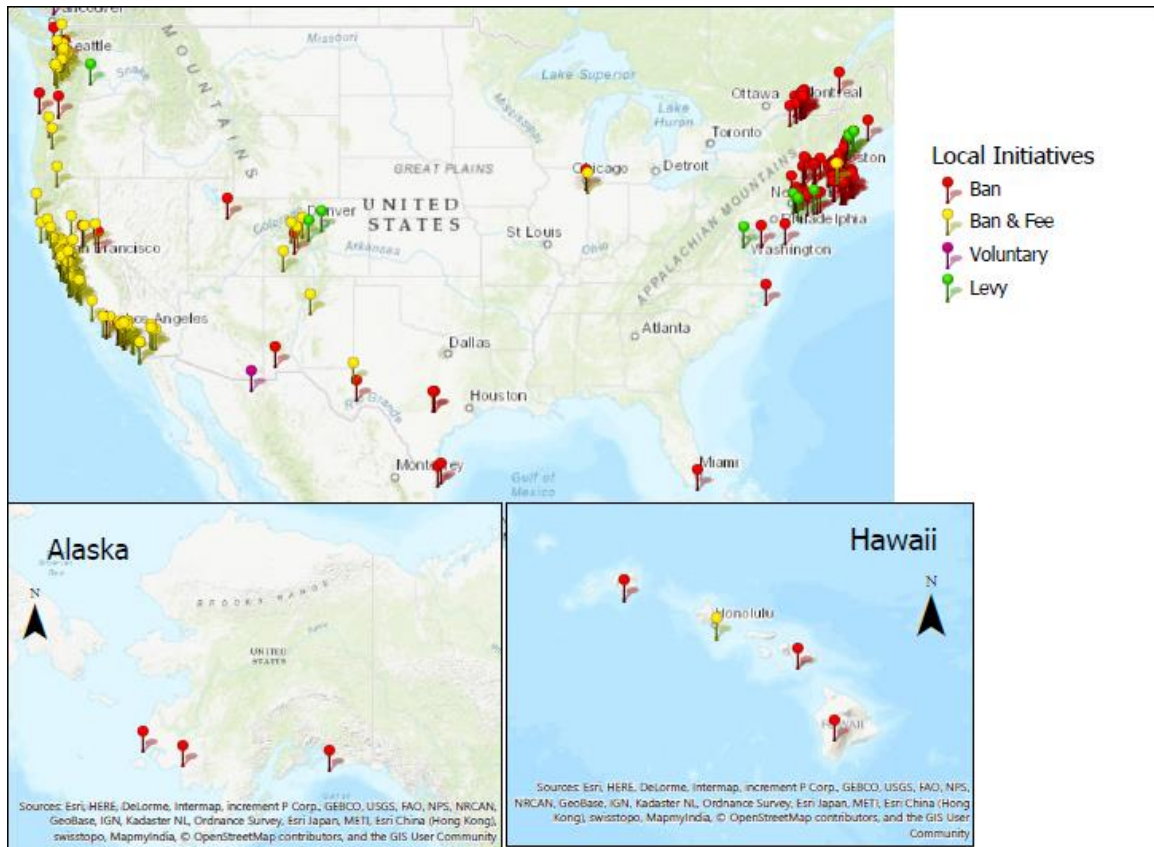

Figure 26. Plastic bag regulations in the USA

These regulations have resulted in significant reduction of single-use plastic bags as well as a reduction in paper bags and an increase in consumers bringing their own bags when shopping. In fact, in Los Angeles County, the single-use bag ordinance resulted in a virtual 100% reduction in plastic bags less than 57 micron thick as well as the use of only 175 000 paper bags annually, less than one per person (County of Los Angeles, 2016). In Santa Barbara, single-use plastic bags reduced by 95% whereas paper bags reduced by 42% with the majority of consumers having switched to reusable alternatives (City of Santa Barbara, 2016). Single-use plastic bags are still present in the city due to non-regulated stores still being allowed to provide LPSBs. Other Californian cities that have been successful in eliminating single-use plastic bags and reducing other single-use bags

include, but are not limited to: Mountain View; Santa Cruz, Alameda County, San Jose and Napa. According to Californians Against Waste (2015) the more than 100 hybrid ban and fee laws have resulted in a reduction of over 5 billion single-use plastic bags as well as 400 million paper bags. On average, before these bans came into effect, 15 billion single-use plastic bags were used in the state. Therefore, these local communities have helped decrease single-use plastic bags by at least 33%.

Effectiveness of Local Voluntary Measures

At the local level, voluntary measures include total elimination, fees, discounts and awareness campaigns. Coles Bay was the first city in Australia to become plastic bag free following an agreement between the towns businesses to stop providing these bags due to their negative impact on wildlife and nature. To encourage the use of reusable bags, every household was given a calico bag. Following their initiative, twelve other cities in Australia became plastic bag free through voluntary agreements (CUA, 2015). These were quite effective, having eliminated all plastic bags in the cities.

Some cities in Japan have also reached agreements with consumer groups and businesses in which a fee is applied to each plastic bag distributed to customers. Similar voluntary initiatives are also taking place in Whistler, Canada and Tirana, Albania which have reduced plastic bag consumption by 43% and 60%, respectively (Dupuis, B., 2016; Shera, U., 2017). The small town of Modbury in Devon, England has also become plastic bag free. In fact, the small town became the first in Europe to get rid of plastic bags when all 43 shops in the town stopped providing plastic bags to their customers in 2007 (Vidal, J., 2007). Ten years later, the town continues to be plastic bag free. The National

University of Singapore has also been charging for plastic bags on campus since 2010 resulting in a 70% reduction in plastic bag use, showing a potential for institutional involvement (Straits Time, 2013).

Application in Canada

Canada is a federation with 11 jurisdictions of governmental authority. The country-wide federal Crown, and the 10 provincial Crowns. Through the Northwest Territories Act, the Yukon Act, and the Nunavut Act, extensive powers of self-government have been transferred to these territories which are closely equivalent to the legislative powers granted to the provinces (Canada Department of Justice, 2015). The Constitutional Act of 1867 distributes the specific powers attributed to these different authorities through articles 91 to 95. However, there is no mention of the environment. Therefore, each level of government has different power to legislate on environmental matters. For instance, according to article 91 of the Constitutional Act of 1867, the federal parliament can make laws concerning, but not limited to, the regulation of trade and commerce, the raising of money by any mode or system of taxation as well as seacoast and inland fisheries. For their part, the provincial parliaments have the power to make laws relating, but not limited to, direct taxation within the province in order to the raise a revenue for provincial purposes, as well as having primary jurisdiction over agriculture, forestry and mining.

When it comes to plastic bags, many activities associated with their production would fall within provincial jurisdiction as matters of local works under article 92(10), property and civil rights under 92(13), matters of private nature in the province under

article 92(16) or relative to their effect on the ecosystem, habitats and wildlife under article 92A. Local communities also have the power to regulate plastic bags due to their ability to regulate with respect to waste management. The federal government also has the power to legislate on environmental matters with respect to criminal law, under which activities harmful to the environment can be prohibited; seacoast and inland fisheries; as well as the power to regulate transboundary transportation and pollution. While these areas would not likely be used to regulate plastic bags, there is room for federal involvement via other means such as implementing a task force to develop national policies to reduce the environmental impact of LPSBs or instituting Canada-wide standards for plastic bags.

Suggested Plastic Bag Reduction Model

Due to the various competencies attributed to all levels of government, the suggested model for Canada would be to implement a task force which would develop a national directive to reduce the impacts and consumption of LPSBs nationwide. The directive could set goals, for example, of decreasing national consumption by at least 50% in the first 5 years and at least 80% after 10 years as well as require that all plastic bags be recyclable, which evidence shows are reasonable targets. This 10-year objective would need to be monitored regularly to ensure that the directive is being followed and that enforcement is adequate. Provinces would be free to decide how they wish to reach these objectives, similar to the EU Directive 2015/720.

Based on the findings from this thesis, it is suggested that provinces and territories should consider a national levy of at least 0.10USD on all plastic bags regardless of

thickness. By opting to not discriminate between types of plastic bags, there would be less confusion around the levy, which is often the case when only certain types of bags are subject to regulations. Ensuring proper compliance would also be easier since the legislation would apply to all types of plastic bags regardless of their thickness or composition. To ensure continual compliance, the levy should also be set to increase every two years by at least 0.02USD to effect a graduated phase-out.

Finally, local communities would be encouraged, by the task force, to also take part in implementing their own strategies to reduce plastic bag consumption by instituting complete local bans. Reusable alternatives would need to be provided at checkouts to provide an environmentally friendlier alternative to customers. This would encourage customers to reuse the bags and see them as indispensable possessions rather than a disposable convenience. Educating the local community by instituting awareness campaigns prior to the implementation of the ban would also be necessary to ensure compliance. The national task force could also work towards providing a reusable bag to households within these communities in order to encourage the use of reusable bags.

Projected Effects of the Model for Canada

Although the provinces of Quebec and Ontario have previously been effective in reducing their consumption of plastic bags due to voluntary measures, plastic bag use has increased following the termination of these measures, which has resulted in an overall national increase. This is due in part to an increase in population as well as many retailers abandoning their fee on single-use plastic bags. In fact, in Quebec, between 1.4 and 2.7 billion plastic bags are distributed annually compared to less than 1 billion in 2010 when

the voluntary reduction target was achieved (City of Montreal, 2018). Therefore, the latest estimate on plastic bag consumption as a whole in Canada is set between nine- and 15- billion plastic bags a year (Suzuki, 2012). Based on the 2017 population of 36 708 100 people, plastic bag consumption is set between 245 and 408 plastic bags per person a year, a median of 327 bags per capita. Based on this median value and expected population increase, national consumption is set to increase to 13 037 362 326 in the next ten years (Figure 27). The annual increase in plastic bags throughout the country would mean that between 2018 and 2028, over 138 billion plastic bags will be used in Canada. The use of these plastic bags would result in the consumption of over 4.3-billion kg of public water supply, over 218-billion kg CO₂eq, over 63-billion MJ of fossil fuel and feedstock, and over 2-billion liters of crude oil.

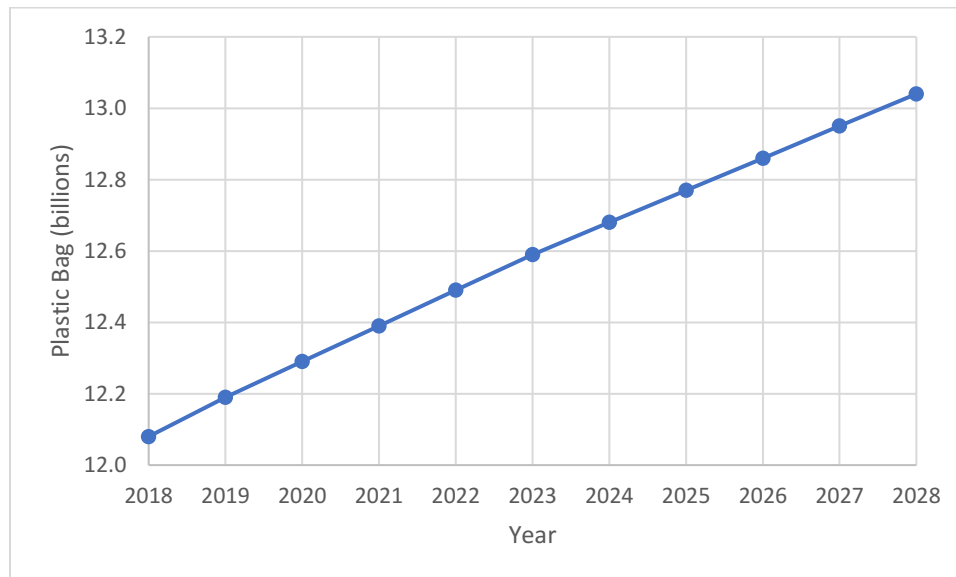

Figure 27. Business as usual consumption of plastic bags in Canada

Instituting a fee on plastic bags through levies or voluntary measures has been shown to significantly reduce consumption at both the national and regional levels. Increasing the levy every few years, prevents customers from getting used to the fees

which would also help prevent increases in the use of plastic bags after a few years and ensure continual reduction. The national directive would also assist provinces to enact awareness campaigns on the impacts of plastic bags prior to instituting mandatory levies, which would help ensure compliance when the levies are put in place. Based on results from the national and regional levels, a 50% reduction could be reached in less than 5-years, however, reaching an 80% reduction may be more difficult. However, by gradually increasing the fee, plastic bag consumption is likely to decrease as was the case in Ireland. Therefore, if an 80% reduction is reached, only 2 607 472 465 bags would be used in the country in 2028, equivalent to 65 plastic bags per capita, a little over one bag per week.

Local communities would increase this reduction by instituting complete bans. In fact, bans have been shown to be quite successful in eradicating plastic bags in local communities, as was the case for many cities in Canada and the United States. To ensure success of these bans, awareness campaigns and availability of alternatives would be essential.

Chapter IV

Discussion

With the world population increasing by millions every year, demand for plastic products is expected to increase as well. In fact, it is expected that the demand for plastic products worldwide will continue to grow faster than the economy (Government of Canada, 2017). This substantial increase will likely have devastating impacts on the planet's environment, such as an increase in greenhouse gases, pollution and wildlife deaths. A plastic product that is often taken for granted in today's consumer society is the ubiquitous lightweight plastic shopping bag, which is often given away free of charge at checkouts across all business sectors. This examination of actions taken around the world clearly demonstrates that by putting restrictions on these items, environmental impacts can be greatly reduced.

Many legal and voluntary measures were identified at the national, regional and local levels of government worldwide. In order to more effectively reduce plastic bag consumption, the findings of this thesis suggest that countries should implement a levy on all plastic bags and if there is a lack of action at the national level, regions should themselves implement this levy. Local communities are also encouraged to ban plastic bags within their districts as a supplementary measure. If countries are hesitant to implement restrictions throughout their nation, it is also suggested that they implement a national directive, similar to the European Union Directive 2015/720. This strategy provides greater flexibility to regional and local governments which can decide for themselves which reduction measure is more appropriate for their populace.

Strategies at the National Level

Almost half of the world's countries were identified as having implemented some kind of measure aimed at reducing LPSB consumption within their nation. Amongst these countries, four main types of strategies were recognized. These consist of bans, levies, voluntary initiatives as well as hybrid ban and levy measures. Although there were only four main strategies identified, there exists great variation within singular measures. For instance, some countries have complete bans whereas others have partial bans based on bag thickness and/or composition. The same applies to levies, where some countries only charge for thin or non-biodegradable plastic bags whereas others impose a mandatory fee on all types of plastic bags.

Throughout the years, all four measures have reached a certain level of success in at least one country. However, some strategies have been more successful than others by reaching more significant reduction in a wider range of countries. For example, imposing a ban on plastic bags has been shown to significantly reduce plastic bag consumption in Rwanda. This success has, however, not been universal amongst countries having instituted bans. In fact, lack of enforcement, lack of alternatives and opposition from policy makers and producers have often contributed to the ineffectiveness of most countries. These factors were instrumental in Rwanda's success. The country is indeed very active in enforcing their ban by confiscating plastic bags at airports and borders as well as tracking down trafficking networks. This shows that implementing a successful ban is possible, but strong enforcement would be an essential factor to consider.

A hybrid ban and levy strategy was also shown to be partially successful in Taiwan, where plastic bag consumption fell 80% shortly after implementation. However,

this drastic reduction did not last and consumption has increased since. In other countries having instituted this legal measure, the majority of them have not shown significant effectiveness, perhaps because the ban portion is ignored. For the most part, the levy portion of the ban is respected, which reduces plastic bag consumption to some extent, so it is hard to tell if the measure might not be a success if it were actually applied. This results in thin plastic bags still being distributed free of charge and thicker plastic bags being provided at a fee. Due to the fact that the laws are not being followed adequately, this legal measure, as applied, cannot be deemed a success.

The lone levy and voluntary initiative options are the remaining measures to be discussed. Levies were identified as the most effective strategy, however, combining this measure with factors from voluntary initiatives may yield better effectiveness. When it comes to levies, there was great variation in the types of charges imposed. In fact, some countries impose their fee on importers, distributors and/or producers whereas others impose them on consumers. All these strategies have been shown to significantly reduce plastic bag consumption. For instance, a high import tax on non-biodegradable plastic bags significantly reduced the importation of these bags in the Maldives. When it comes to the charges levied on consumers, some countries have relatively low fees whereas in others the fee is quite high. A regression analysis concluded that there was significant correlation between the amount charged and the reduction witnessed. In fact, the larger the fee, the greater the reduction. To reach at least 50% reduction in the first year, a fee of 0.007USD to 0.10USD is suggested. However, the initial shock of the fee does not seem to be permanent. Therefore, a continuous increase in the fee throughout the years is suggested in order to maintain significantly low consumption. By combining a high tax

on importers with a continuously increasing fee on consumers, plastic bag consumption in countries would be expected to decrease significantly. In fact, the initial tax on importers would reduce the number of plastic bags entering the country whereas the fee on consumers would further this decrease by changing consumer behavior.

Factors contributing to the success of voluntary measures should be combined with the mandatory levy in order to enhance effectiveness. Although the retailer led voluntary initiatives were shown to only have a small impact on overall national consumption, the success within the stores alone suggests that when businesses take action, results can be quite significant. It is therefore suggested that prior to the implementation of a mandatory levy, governments should work with retailers and supermarkets to ensure their compliance. The formation of a task force could also help smaller levels of government work with these businesses. Awareness campaigns concerning the impending levy should also be carried out in store to reach the public's attention at the source. By initiating these measures, countries would be able to reduce the number of plastic bags consumed as well as the amount of waste generated by plastic bags. However, consumption will unlikely be completely eradicated. Therefore, to reduce the number of plastic bags entering landfills, recycling programs should be instituted in collaboration with retailers and supermarkets. Through these programs, consumers would be able to discard their plastic bags appropriately at stores. This would help minimize the environmental impacts associated with the wrongful disposal of plastic bags as well as reduce the stress that plastic bags pose in conventional municipal recycling plants.

Strategies at the Regional Level

The findings of this thesis have also suggested that regional initiatives reach similar results to national initiatives. In fact, just like at the national level, regional governments have had some difficulties implementing bans, whether they be partial or complete. Lack of enforcement, lack of available cost-effective alternatives and opposition from policy makers as well as producers and distributors were once again identified as key contributors to the ineffectiveness of bans. Another factor undermining regional ban efforts is a loop-hole resulting from partial bans. In fact, these types of bans only prohibit plastic bags below a certain wall thickness or non-biodegradable plastic bags. Thicker and biodegradable bags continue to be used. Therefore, although these bans reduce consumption of some types of plastic bags, consumer behavior does not seem to change, and plastic bags continue to be a nuisance in these regions.

When it comes to levies, although only a few regions have opted for this strategy, their results are similar than at the national level. In fact, regions such as the Northwest Territories in Canada, the District of Columbia in the United States and Victoria in Australia have all reached at least 70% reduction in plastic bag use following the implementation of the levies. These regions require retailers and supermarkets to charge for every plastic bags distributed to their customers. The fees range from 0.05USD to 0.20USD and consumption in the Northwest Territories and the District of Columbia has remained low since the implementation of the levies.

Voluntary measures have also been shown to be successful in some regions such as Ontario and Quebec, Canada, where agreements between the retail sector and the provincial governments resulted in a 50% reduction in three years. Measures instituted by

these provinces include voluntary fees on plastic bags imposed on customers, better bagging practices as well as incentivizing the use of reusable alternatives by providing a rebate to customers who brought their own bags. Although initial results were positive, the termination of the agreements saw many retailers abandoning their fee on plastic bags which in turn resulted in an increased use of plastic bags. Success was therefore only temporary and dependent on retailer participation. This shows that when retailers get involved and have a say, reduction efforts can be quite significant.

Finally, many eastern states in the United States have implemented mandatory or voluntary recycling programs. Although these programs do not help reduce plastic bag consumption, they help educate the public on appropriate disposal of LPSBs. However, to ensure their effectiveness, more retailers should be required to provide appropriate recycling bins in stores and more extensive awareness campaigns should be conducted to increase public responsiveness to these measures.

Therefore, when lack of action is present at the national level, regional governments should be allowed to institute their own plastic bag reduction efforts which would consist of a minimum fee of 0.07USD on all types of plastic bags provided to customers in all retail sectors. To ensure reduction efforts are met, retailers and supermarkets should be consulted prior to the implementation of the mandatory levy, an awareness campaign should be conducted for at least 6-months leading to the date of enactment, and appropriate recycling bins should be positioned at stores to encourage better disposal of the plastic bags used. A range of cost-effective reusable alternatives should also be available at checkouts, to encourage their use.

Strategies at the Local Level

At the local level, results differed from what was witnessed at the national and regional levels. In fact, both the lone ban strategy and the hybrid ban and levy strategy were shown to be effective in reducing plastic bags in local communities. In fact, the hybrid measure instituted in many cities and counties in California has resulted in the reduction of the banned plastic bags, however, the bans are only partial. Thicker plastic bags and biodegradable bags continue to be permitted, but at a fee. Although these permitted bags continue to be used, their consumption is much less abundant than when no fee is applied such as in a lone partial ban strategy.

There are several possibilities when implementing a local plastic bag ban. Firstly, determining which businesses are to be affected. Some communities only apply the bans to large establishments so as not to encumber smaller, family-owned businesses. Another factor to determine is the type of plastic bags to be banned. Some places ban plastic bags based on thickness which ranges from plastic bags below 38 to 100 microns thick whereas other places ban plastic bags made without biodegradable materials. Finally, if a partial ban is in place, local communities must also consider whether they will impose a fee on the permitted bags.

The findings of this thesis suggest that local communities should implement a total ban on plastic bags throughout all retail sectors. By implementing partial bans, plastic bags continue to be used and disposed of after a single use even if the thicker bags are considered to be reusable. To be successful, reusable alternatives made of environmentally-friendly materials must be provided at checkouts. Retailer and supermarkets should be given the choice to charge for these bags or not as to give more

freedom to these establishments and minimize opposition. However, it is highly encouraged to have a minimal fee for these bags. This fee would help consumers regard the reusable bags as durable items instead of throwaway items.

To increase the likelihood of success, awareness campaigns should be conducted at least 6-months leading to the execution of the ban. Businesses should also be given the time to rid themselves of their existing stocks. Finally, to encourage the use of reusable bags, municipalities could distribute a reusable environmentally friendly bag to all households within their limits.

Conclusion

To conclude, there are many possibilities of success when working towards reducing the consumption of plastic bags in a country. These include national, regional and local measures. Levies have been shown to be most successful when applied at the national and regional levels whereas bans are most successful in local communities. To ensure continual success of these measures, the initiatives should periodically be brought back into the spotlight. To do so, levies should be increased every few years and monitoring of plastic bag use should be mandatory. Reports should therefore be published and available to the public so that communities are aware of the improvement they have brought to their environment. These reports should be done by a national task force who would also be responsible for the monitoring national progress. The charges levied should also go towards environmental programs to help the communities being charged. In this way, the public sees where their money is going and the levies are not seen as additional sales taxes which could incite opposition.

When applied to Canada, the projected results of this model suggest that by changing only one consumer habit (i.e. plastic bag consumption), a country can save substantial amounts of water, oil as well as decrease their greenhouse gas emissions (CO₂eq). However, to ensure this success, enforcement must be strong and cost-effective environmentally friendly alternatives must be provided to customers.

Appendix A: Worldwide National Initiatives

Country	Type	Year	Details
Africa			
Benin	Ban (Proposed)	2016	A law seeking to ban the importation, distribution and use of plastic bag was proposed in 2016. As of September 2017, the proposed law has not yet passed, but is under review by the government. However, the government has taken the initiative to inform the population about the impending law as well the impacts caused by single-use plastic bags. The promotion of biodegradable plastic bag is also underway (Sossou, I., 2016; Keko, I., 2017; Tossavi, L., 2017).
Botswana	Ban & Levy	2007	In 2006, the Botswana Bureau of Standards established a compulsory standard for plastic bags. This standard covered printing requirements and thickness of domestically produced and imported plastic barrier bags and flat bags (Botswana Bureau of Standards, 2017). Although the plastic bag legislation was passed in 2006, it wasn't until July 2007 that it was fully implemented. It also came with a levy to support environmental initiatives, but retailers were free to decide what they wanted to charge for the bags as long as this cost was transparent and disclosed publicly (Dikgang and Visser, 2010). Typically, retailers charge between 0.035USD and 0.07USD (Baaitse, F., 2015).
Burkina Faso	Ban	2015	Following a series of debates relating to chemical use and waste in 2014, the Burkina Faso Parliament endorsed several laws promoting sustainable development. One of these, was the law prohibiting the production, importation, marketing and distribution of non-biodegradable plastic bags. The law came into effect on February 2 nd , 2015 (United Nation Environment Programme, 2015)
Cabo Verde	Ban	2016	In March 2015, a law prohibiting the importation, manufacture and use of plastic bags was approved by the Council of Ministers. Excluded from this law are biodegradable plastic bags and bags used for hygiene purposes. Therefore, in July 2016, the manufacture and importation of single-use plastic bags were prohibited and as of January 2017, the distribution and use of these bags have

			also been banned. This gave a 6-month window for retailer to phase-out their stocks (Cabo Verde Council of Ministers, 2015).
Cameroon	Ban	2014	In October 2012 was signed a joint order by the Minister of Commerce and the Minister of Environment, Natural Protection and Sustainable development, which prohibits the manufacture, importation, use and marketing of non-biodegradable plastic bags. The order states that non-biodegradable plastic bags less than or equal to 60 microns thick are prohibited. Non-biodegradable plastic bags more than 60 microns thick are subject to an environmental permit (Pierre & Atangana, 2012). A press release by the Government of Cameroon in February 2013 indicated that the prohibition was passed and will be effective as of April 24 th , 2014 (Michelot, P., 2014).
Republic of the Congo	Ban (Failed)	2012	A ban on the manufacture, importation and use of single-use plastic bags came into effect on January 20 th , 2012 (Bienvenu Wanga et al., 2014). Unfortunately, lack of enforcement has resulted in the establishment of a black market. Retailers are ignoring the law and providing bags to their customers (Loukoula, 2016).
Cote d'Ivoire	Ban	2014	In May 2013, a decree to ban the manufacture, importation, marketing and use of plastic bags (non-biodegradable and biodegradable) was signed by the General Secretary, Sansa Kambile. The law gave 6 months to comply. However, complaints from the plastics industry delayed the implementation until November 2014 (Ouattara, A., 2013; Moihet, G., 2016).
Djibouti	Ban	2016	Since May 2016, the importation and commercialisation of non-biodegradable plastic bags produced outside of the country is prohibited (President Guelleh, 2016). However, this does not prevent local entrepreneurs to start or continue manufacturing/distributing plastic bags in the country.
Egypt	Voluntary	2017	On June 5 th , 2017, the Minister of Environment, Dr. Khaled Fahmy, launched the “National Reduction of Plastic Bag Initiative” in partnership with the United Nations Environment Programme and the Center for Environment and Development for the Arab Regions and Europe (CEDARE). This initiative aims to join forces with retailers, supermarkets, pharmacies, and many others, to

			change consumer behavior and encourage environmentally-friendly alternatives (CEDARE, 2017).
Eritrea	Ban	2005	An outright ban on plastic bags has been implemented in Eritrea since 2005. The bags have since then been replaced by nylon and cotton bags (Tubei, G., 2017).
Ethiopia	Ban	2011	As part of the Green Growth Strategy, Ethiopia banned the importation and manufacture of plastic bags less than 30microns thick. Mr. Mehari Wendimagegn, a director in the Environment Ministry has, however stated in 2016 that the ban has not been fully implemented and that penalties will start to be enforced for companies that do not comply with the law. (Nicholls, F., 2016; Tekleberhan M., 2011).
Gambia	Ban	2015	A complete ban on the importation and use of plastic bags came into effect on July 1 st , 2015. The law was enacted due to the serious threat posed to the country's fragile ecosystem (Bah, S., 2015).
Ghana	Ban (Proposed)	2015	A ban on lightweight plastic bags was proposed in mid-2015. However, due to opposition from producer and policy makers, the ban was never passed (Amponsem, J., 2017).
Kenya	Ban	2017	After two attempts through the years, plastic bags have finally been banned in Kenya as of August 28 th , 2017. The ban applies to all bags used for commercial and household packaging (Wakhungu, J.W., 2017). Although the law did not specify alternatives, supermarkets are expected to provide reusable and/or eco-friendly bags at a charge to consumers (Le Monde Afrique, 2017).
Madagascar	Ban	2015	A ban on the manufacture, importation, marketing and use of plastic bags was first introduced on October 7 th , 2014 and came into effect in October 2015. Plastic bags less than 50 microns thick were henceforth banned. However, due to some lack of preciseness in the decree lightweight plastic bags without handles continued to be provided to consumers. For this reason, the decree was replaced in 2017 by another decree which strengthened the ban. Not only were plastic bags without handles added to the ban, but the thickness of the bag as well as manufacturer name must be provided on the bags (Ralitera, M., 2017; Mahafaly-S., O., 2017).

Malawi	Ban	2015	The Environment Management (Plastics) Regulations, 2015 bans the importation, manufacture, trade and commercial distribution of plastic bags less than 60 microns thick. Plastic bags with and without handles are subject to this ban. The regulations also require that the name and registration number of the manufacturer as well as the thickness of the bags must be indicated on the allowed bags (Muluzi, A., 2015).
Mali	Ban (Failed)	2012	On June 12 th , 2014, a law to ban the production, importations and trade of non-biodegradable plastic bags was passed by the National Assembly. Bags were to be replaced by biodegradable plastic bags which biodegrade within 18 months. However, the law was never implemented, and non-biodegradable plastic bags continue to be used in the country (Keita, I.B., 2014; Coulibaly, M., 2017).
Mauritania	Ban	2013	A law banning the importation, distribution, manufacturing and use of all plastic bags was introduced in July 2012. The primary objective of this ban was to protect the environment as well as the lives of land and sea animals. In fact, an estimated 70% of cattle and sheep in the Mauritania capital were said to be killed by the ingestion of plastic bags. The ban came into effect in January 2013 (Tubei, G., 2017; GRET, 2013).
Mauritius	Ban	2016	The Environment Protection (Banning of Plastic Bags) Regulations 2015 was published on August 6 th , 2015 in the Government Gazette of Mauritius. These regulations indicated that import, manufacture, sell and supply of all plastic bags of any size or type, with or without gussets shall be banned. The plastic bag prohibition came into effect on January 1 st , 2016.
Morocco	Ban	2016	The Moroccan law no. 77-15 was published in the Official Gazette No.6422 on December 12 th , 2015. The law prohibiting the manufacture, importation, exportation, trade and use of plastic bags came into effect in July 2016. Efforts to ban plastic bags was first made in 2009, however, authorities struggled to restrict the production of these bags. In fact, Morocco is the second largest consumer of plastic bags after the United States, using on average 900 plastic bags per person per year. The ban seeks to curtail the consumption, although some say it will get some getting used to (Alami, A., 2016).

Mozambique	Ban & Levy	2016	On June 30 th , 2015, the Mozambican Council of Minister approved a law to curtail plastic bag consumption in the country. The law was officially published in the Government Gazette on August 5 th , 2015. In an effort to reduce the negative impacts posed on human health, infrastructure, biodiversity and the environment in general, the law states that the importation, manufacture, trade and use of plastic bags less than 30 microns thick in retailers and supermarkets shall be banned. It also requires that no plastic bag shall be given free of charge. A 6-month moratorium, following the publication of the law, was given to comply with the requirements. It therefore came into effect on February 5 th , 2016 (Mozambique Council of Ministers, 2015).
Niger	Ban	2014	In November 2014, the government adopted a law to prohibit the manufacture, use and trade of plastic bags in the country, but its implementation has been problematic. It took three years before the government took its first steps towards enforcing the law. In fact, as of August 16 th , 2017, the importation of plastic bags in the country has been banned. The implementation will be soft at first, to allow the population to get used to a country without plastic bags as well as to give some time for existing stocks to gradually phase-out (Morin, C., 2017; Bayo Jr., I., 2017).
Nigeria	Ban (Proposed/ Failed)	2013	In 2013, an announcement was made by the Minister of Environment, Hadiza Mailafia, stating that lightweight non-biodegradable plastic bags will be banned by January 1 st , 2014. However, following this statement, no serious action was taken and no law was implemented (Obateru, T., 2016).
Rwanda	Ban	2008	In 2008, the Rwanda Government passed a law that prohibits the manufacturing, use, importation and sale of all plastic bags (Kgame, Makuza & Karugarama, 2008). To promote this law and ensure its long-term success, campaigns were put into place to inform the population as well as travellers and an institution was put in charge of its enforcement. Alternatives were also provided, such as cotton and biodegradable products (McClatchy & McClatchy, 2012).
Senegal	Ban & Levy	2016	On January 4 th , 2016, a law relative to the importation, production, distribution and use of lightweight plastic bag came into effect in Senegal. The law states that plastic bags less than 30 microns thick are banned nationwide and that those

			superior or equal to 30 microns shall not be provided free of charge. A system has also been implemented for the recovery of all plastic products in order to recycle or dispose of these products properly (Sall, M., 2015).
Seychelles	Ban	2017	The Environment Protection (Restriction on manufacturing, importation and distribution of Plastic Bags) Regulations 2017, which comes under the Environment Protection Act, 2016, states that:” the manufacturing, importation, distribution of plastic bags, for use within the Republic of the Seychelles, which does not fall into the category of exempted plastic bag [...] are hereby prohibited”. Eleven types of bags are exempted from the law, including those used for disposal of waste, re-sealable bags used for medical use and bags designed for agricultural purposes (Dodgely, D., 2017). The ban came into effect in January 2017, but companies were given until July 2017 to phase-out their remaining stock (Laurence & Bonnelame, 2017).
South Africa	Ban & Levy	2003	Plastic bag litter was once so common in South Africa, that the ubiquitous item was proclaimed the ‘national flower’. For this reason, a memorandum agreement was signed between the Department of Environmental Affairs and Tourism (DEAT); organised labour represented by the Congress of South Africa Trade Union, and National Council of Trade Unions; and organised business represented by Chemical and Allied Industries Association, Plastics Federation of South Africa, Plastic Recyclers Employers Organisations, and the Retailers Plastic Bag Working Group. The agreement established a minimum thickness for plastic bags at 30 microns (with a 20% margin of tolerance for five years), requirements for printing of the bags as well as disclosure of transparency and a mandatory levy imposed on manufacturers but recovered by consumers. Other agreements were also made concerning enforcement, job creation and illegal imports (Department of Environmental Affairs and Tourism, 2002). This led to the implementation of legal regulations which were gazetted and passed into law on May 9 th , 2003 (Nhamo, G., 2003).
Tanzania	Ban (In progress)	2006; 2015; 2017	The government has tried since 2006 to regulate the use of plastic bags. Their first attempt was to ban bags less than 30 microns thick, then in 2015 they extended to plastic bags less than 50 microns thick (Mtulya, A., 2016). It is

			unclear whether these bans have been enforced and respected. More recently, the government announced that it will implement a ban on all plastic bags, regardless of their thickness. The ban was set to be enacted in January 1 st , 2017, but it was later pushed to June 2017, however, it has yet to come into force (Dar Post, 2017).
Togo	Ban	2014	In early 2011, a decree was signed to regulate plastic bags in Togo. The decree bans the importation, manufacture, distribution and trade of all nonbiodegradable plastic bags. Only biodegradable plastic bags as well as bags used for medical, pharmaceutical and agricultural are permitted. The permitted bags must also be recyclable (Republique Togolaise, 2011). Following multiple delays and extensions, the ban finally came into force in November 2014 (aLome News, 2014).
Tunisia	Voluntary	2017	Following an agreement between the Ministry of Local Affairs and Environment and major supermarket chains, lightweight plastic bags (under 50 microns thick) were banned in supermarkets nationwide. Bags with a thickness superior to 50 microns are provided to customers at a fee, in hopes that this will incentivise shoppers to bring reusable bags. The agreement took effect in March 2017 (Martinko, K., 2017; Quillen, S., 2017).
Uganda	Ban & Levy (Failed)	2007	In 2007, the Ugandan Finance Minister, Ezra Suruma banned the use of thin plastic bags and imposed a tax, at a punitive rate of 120%, on thicker plastic bags. The ban was supposed to come into effect in July and gradually phase-out thin plastic bags until September 2007. Unfortunately, the law has never been enforced and has failed to significantly reduce consumption (BBC News, 2007; Business Insider, 2017).
Zimbabwe	Ban & Levy	2010	The Statutory Instrument 98 of 2010 prohibits the manufacture for use within Zimbabwe as well as the distribution and importation of plastic bags less than 30 microns thick. Shops may charge 0.08USD per bag. However, retail shops and consumers considered that there was not adequate consultation on the part of stakeholders and the general public. There has therefore been resistance when it comes to the implementation of this regulation. Some shops have smuggled

			smaller plastic shopping bags from Mozambique and people are gradually resorting back to flimsy plastic bags (Chitotombe, J.W., 2014).
Asia			
Afghanistan	Ban (Failed)	2011	In early 2011, Afghan President Hamid Karzai led an effort to ban the use of single-use plastic bags in his country (Tamminen, T., 2011). However, the ban did not work. Experts believe that this failure is due to lack of enforcement and was only symbolic in nature (Amanpoor, A.S., 2014).
Bangladesh	Ban	2002	In the late 1990s, plastic bags were blamed for blocking city drains and causing massive flooding. For this reason, a ban was established in 2002 (Earth Policy Institute, 2014). The ban was first implemented in the Bangladeshi capital and was then promulgated nationwide by March of the same year (Alam, H., 2010). However, reports suggest that lack of enforcement and the absence of cost-effective alternatives have resulted in a still active use of these products (IRIN, 2011).
Bhutan	Ban (Failed)	1999; 2005; 2012	The government attempted to ban plastic bags in 1999, however, lack of available alternatives resulted in very poor results. For this reason, the ban was reintroduced in 2005, this time putting in place some alternatives such as cloth bags and biodegradable plastics. However, plastic bags continued to proliferate, especially in larger urban centers. Therefore, in 2012, the Waste Prevention and Management Regulation came into place, but lack of enforcement continues to be a problem (Phuntsho, S., 2013).
Brunei	Voluntary	2011	In 2011, the Ministry of Development launched the ‘No Plastic Bag Day’ campaign to encourage the use of reusable bags and reduce plastic bag consumption on weekends, i.e. Saturday and Sunday. Retailers, supermarkets, markets, etc. could voluntarily agree to implement this campaign. The initiative was well received and in February 2012, Fridays were added to the campaign (Department of Environment, Parks, and Recreations, 2013).
Cambodia	Ban & Levy	2017	A draft of the Sub-decree on plastic bags management was finalized in early 2017 and should be enacted by the end of the year (Fondazione ACRA, 2017). This sub-decree stipulates that the production and importation of plastic bags

			smaller than 25cm wide will be banned. Supermarkets will also be required to charge 0.12USD per bag at the checkout (Sothear & Stackhouse, 2016).
China	Ban & Levy	2008	Since January 1 st , 2008, plastic bags less than 25microns thick can no longer be provided in shops, supermarkets, and sales outlet (Block, B., 2016). Additionally, as of June 1 st , 2008, per the Administrative Measures for the Paid Use of Plastic Bags at Commodity Retailing Places (2008), plastic bags not included in the ban could no longer be provided free of charge to customers. Retailers may determine independently what they will charge, however, the price cannot be inferior to the cost.
Georgia	Ban	2017	Starting in September 2017, plastic bags with a thickness inferior to 10microns will be banned. Use, importation and sell of these bags will be prohibited. In January 2018, this ban will be extended to bags of 15microns or less in thickness (Menabdishvili, M., 2017).
Hong Kong	Levy	2009; 2015	A levy was first introduced in July 2009. However, only approximately 3000 retail outlets were targeted. They were mainly supermarkets, convenience stores, and pharmacies. The levy was successful in decreasing plastic bag consumption in these stores however, due to the small scope of the charge, overall consumption in Hong Kong continued to increase (Environmental Protection Department, 2015). As such, the government of Hong Kong decided to extend the charge to all retail outlets. The Product Eco-responsibility (Amendment) Ordinance 2014 was therefore passed and took effect on April 1 st , 2015. This ordinance requires all retailers to charge 0.06USD for plastic shopping bags whether they are made wholly or partly of plastic. Exceptions apply if the bags are used for hygiene purposes (Leung, C.Y., 2014).
India	Ban (Proposed/ Failed)	1999	Various levels of government have attempted to ban plastic bags in India. In 1999, the Indian government attempted a nationwide ban, however, this was unsuccessful (Earth Policy Institute, 2014).
Indonesia	Trial Tax (Bill pending)	2016	In 2016, 23 cities across Indonesia were chosen to enact a trial tax on single-use shopping bags. Although the tax resulted in a reduction in plastic shopping bag consumption, customers and retailers remain hostile towards a legal tax This has

			delayed a bill aimed at reducing plastic bag consumption nationwide through a tax (Langenheim, J., 2017).
Israel	Ban & Levy	2017	On March 28 th , 2016, the Plastic Bag Law was passed and took effect January 1 st , 2017. The new legislation, which affects the country's 20 largest supermarkets, bans the distribution of plastic bags less than 20microns thick and requires supermarkets to charge a 0.10USD levy on bags between 20 and 50microns thick. To encourage the use of reusable bags, the Ministry of Environmental protection subsidized the distribution of these bags from January 1 st to January 17 th , 2017 in participating supermarkets (Israel Ministry of Environmental Protection, 2017).
Japan	Voluntary	2011	AEON, a retail group in Japan, was the first to ban free distribution of plastic bags. The charge was first introduced in their main store but has since then expanded to over 1000 outlets (AEON, 2015). Since AEON's pioneering initiative, many other supermarkets in the county have started to charge for plastic bags at checkout. The fee usually ranges between 0.02USD and 0.04USD, depending on the size of the bag (Brasor & Tsubuku, 2013).
South Korea	Levy (& ban agreement)	2001; 2011	South Korea has a plastic bag levy since 2001 (Niaounakis, M., 2017). In 2011, the Ministry of Environment reached the 'Stores That do without Disposable Plastic Bags' agreement with five major shopping centers. Altogether, approximately 800 supermarkets nationwide are under the agreement and do not provide disposable plastic bag to their customers (South Korea Ministry of Environment, 2013).
Malaysia	Voluntary	2011	In 2011 Malaysia launched a 'No Plastic Bag Day' campaign. Participating stores charge 0.05USD for each new plastic bag requested by customers on Saturdays (Asmuni, Hussin, Khalili & Zain, 2015; Niaounakis, M., 2017).
Maldives	Levy	2012	The Maldives Customs Services charges a very high tariff for the importation of non-biodegradable plastic bags. Taxation rates are implemented in such a way that the importation of plastic bags is discouraged. In fact, there is zero tax rate on biodegradable plastic bags, 15% tax rate on other than biodegradable bags and 400% tax rate on non-biodegradable bags (Mohamed, M., 2016).

Mongolia	Ban (Failed)	2009	The “Law on Prohibition of Plastic Bag Usage” was adopted in 2009. This law prohibited the use as well as the importation of plastic bags less than 25microns thick in any trade nationwide. At first, the law had a positive impact, however, this did not last. When the law was incorporated in Waste Legislation, original enforcement was greatly affected. Markets and citizens turned once again to plastic bags due to their affordability and ability to personalize the bags with retailer logos (Zolijargal, M., 2013).
Nepal	Ban (On hold)	2016	In 2016, the government introduced the Plastic Bag Directive 2016 for a national ban on the importation, exportation, distribution and use of plastic bags below 30microns. The ban was set to take effect on July 17 th , 2016, however, major opposition from the plastic industry resulted in the government delaying the enactment date by one month. The delay was supposed to be used to look for alternatives. Unfortunately, as of July 2017, the directive has yet to come and plastic bags continue to roam the country (Kathmandu Post, 2017).
Philippines	Ban (Proposed/Pending)	2011; 2013; 2014; 2015	In 2011, the Plastic Bag Regulation Act of 2011 was presented to the House of Representatives. The Act was approved on second reading and passed to the Senate. It is currently pending in front of the Senate (Earth Justice, 2015). Due to the inactive nature of the Act, a series of bills were presented once again in 2013, to ban the production, importation, distribution and use of plastic bags. Unfortunately, these bills remain Pending in the Committee (Ejercito, J.V., 2013; Fortun, L.L., 2013; Mercado-Revilla, L., 2013). Plastic Bag Regulation Acts were once again attempted in 2014 and 2015, but the same results prevailed (Legard, L.B., 2014; Revilla Jr., R.A., 2015).
Sri Lanka	Ban	2017	Due to a dengue epidemic and garbage crisis in the country, a ban on polyethylene and Styrofoam products came into effect on September 1 st , 2017. A ban on the importation, distribution and use of plastic shopping bags is included in the new law. Plastic shopping bags have been replaced with reusable cloth bags at checkouts (Hui, L., 2017).
Taiwan	Ban & Levy	2002	In 2002, the Taiwanese government introduced a two-lement scheme to reduce plastic bag consumption. Firstly, plastic bags of less than 60microns thick shall be banned, and secondly, an environmental levy shall be implemented at the

			retail level. This regulation applies to approximately 20,000 stores nationwide. Retailers are free to charge what they see fit. The levy usually ranges between 0.03USD and 0.10USD per plastic shopping bag. Due to the success of the tax, the Taiwanese Environmental Protection Administrative announced in July 2017 that it will be expanding the levy to over 80,000 more retailers as of January 2018. However, they will be revoking the minimum thickness imposed on plastic bags (Hong Kong Environmental Protection Department, 2007; Chuan & Chen, 2017).
Turkey	Voluntary	2018	The Turkish Retailers' Federation announced in early 2017 that beginning January 2018, plastic bags will be charged in all their stores. They will also encourage the use of cloth bags or other non-plastic bags (Turkiye Perakendeciler Federasyonu, 2017).
United Arab Emirates	Ban (Failed)	2011	Non-biodegradable plastic bags were supposed to be phased-out in 2013, however, as of March 2016, the ban has yet to be implemented. An estimated 13 billion bags continue to be distributed in supermarkets each year (Arabian Business, 2016).
Vietnam	Levy	2012	In Vietnam, plastic bags are subject to an eco-tax since January 1 st , 2012. Importers and producers are therefore subject to a 1.78USD per kilo tax on plastic bags (Vietnam Law and Legal Forum, 2011).
Europe			
In April 2014, draft rules amending the European Commission's Packaging Waste Directive were approved by the European Parliament. The EU Directive 2015/720 aims to decrease lightweight (less than 50 microns thick) plastic bag use in the EU to 90 bags per person by December 2019 and 40 bags per person by December 2025. Member states are free to choose how they wish to reach these targets. They may also decide to adopt measures ensuring that by December 2018, lightweight plastic bags are not provided free of charge at the point of sale, unless equally effective instruments are implemented (European Parliament and the Council of the European Union, 2015).			
Andorra	Ban & Levy	2013	In 2012, the government of Andorra passed a bill which banned the use of single-use plastic bags as well as biodegradable plastic bags while also charging a minimum of 0.02USD in supermarkets for the provided bags. The law took effect in early 2013 (Govern d'Andora, 2017). However, following the EU Directive 2015/720 for plastic bag reduction, the government decided to tighten

			their regulation. They passed a decree in May 2017 which prohibits thin single-use plastic bags as well as biodegradable, compostable, and oxo(bio)degradable alternatives. Plastic bags must now have a minimum thickness of 50 microns. Stores must also charge 0.12USD for bags made from more than 80% recycled materials and 0.18USD for those made with less than 80% recycled materials. The law comes into effect in November 2017, but small stores have until the end of 2018 to comply with the new regulations (Butlleti Oficial del Principat d'Andorra, 2017).
Austria	Voluntary	2017	Following the EU Directive 2015/720, The Federal Ministry of Agriculture, Forestry, Environment and Water Management signed an agreement with major trade companies and NGOs to reduce plastic bag consumption in the country (Federal Ministry of Agriculture, Forestry, Environment and Water Management, 2017). As of January 1 st , 2017, supermarket chains in the country have stopped distributing plastic bags and instead sell sturdy, reusable alternatives (The Local, 2017).
Belgium	Levy	2007 to 2015	In 2007, the Belgium Finance Ministry instituted an eco-tax which included a tax on single-use plastic bags payable by producers, importers and distributors of 3.25USD per kilogram (Moniteur Belge, 2007; Card, D., 2016). Belgian authorities also have a voluntary agreement with retailers where customers are charged for plastic carrier bags (Lyons, Withana & Lopes, 2013). The eco-tax was abolished in January 2015 because authorities considered that it had reached its objectives. (Card, D, 2016).
Bulgaria	Levy	2011	In March 2011, the Ministry of Environment proposed an eco-tax on plastic bags less than 15 microns thick. The law came into effect in October 2011, payable by those who put the bags on the markets, who in turn pass the fee on to customers. The charge was to increase gradually between 2011 and 2014 (Niaounakis, M., 2017). In 2012, the tax was extended to bags thicker than 15microns (Lyons, Withana & Lopes, 2013).
Cyprus	Levy	2018	In June 2017, Cyprus, along with Greece, Italy and Poland were urged by the European Commission to complete the enactment of EU Directive 2015/720 in their national laws. They were given two months to notify the Commission of

			their measures (European Commission, 2017). Following this last warning, Cyprus announced that it will start charging for plastic bags. The associated bill will come into effect in January 2018 (Andreou, E., 2017)
Czechia	Levy	2018	Although most supermarkets across the country have been voluntarily charging for single-use plastic bags for the past few years, in mid 2017, the Czech president signed an amendment to the Packaging Act which prohibits the free distribution of plastic bags thicker than 15 microns in all stores nationwide. The price of the bag can be decided by the retailer and will be mandatory starting January 2018 (Ministerstvo zivotniho prostredi, 2017).
Denmark	Levy	1994	In 1994, Denmark introduced a tax on plastic bags with a holding capacity of at least 5 litres, in an effort to reduce the use of these bags and prevent waste production. The tax is imposed on importers and distributors who provide these bags to their customers. Consequently, supermarkets have decided to transfer the tax to their customers, who pay between 0.32USD and 0.56USD (The Danish Ecological Council, 2015). Other retailers have yet to charge customers for plastic bags (Kroyer, A.M., 2015).
England	Levy	2015	On October 5 th , 2015, England introduced a 0.07USD (5pence) minimum charge on single-use, non-biodegradable, plastic bags with a wall thickness of 70 microns or less. This charge only applies to large retailers (those of more than 250 employees), whereas smaller retailers may follow the law voluntarily (Department for Environment, Food & Rural Affairs, 2015).
Estonia	Levy	2018	In March 2017, the government of Estonia published an amendment to the Packaging Act 2004. In accordance with the new amendments, plastic bags less than 50 microns thick must not be supplied to customers free of charge, except for plastic bags less than 15 microns which are used for hygiene purposes. This regulation will come into force on December 31 st , 2018 (Estonia State Gazette, 2017).
Finland	Voluntary	2016	To comply with the EU Directive 2015/720, the Ministry of Environment concluded a Green Deal agreement with the Federation of Finnish Commerce. This voluntary agreement allows retailers to reduce plastic bag consumption as they see fit. However, companies which join this agreement must at least charge

			for plastic bags with a wall thickness below 50 microns and can no longer provide plastic bags with a wall thickness inferior to 15 microns, unless they are used for hygiene purposes (Finnish Ministry of Environment, 2016).
France	Ban	2016	<p>As of July 1st, 2016, lightweight shopping bags less than 50 microns thick are banned in all stores nationwide. The ban extended to lightweight bags destined for hygiene purposes as well as non-biodegradable and non-compostable plastic bags on January 1st, 2017 (Ministères Économiques et Financiers, 2017).</p> <p>The supermarket chain E.Leclerc has also been involved in voluntary campaigns to reduce plastic bag consumption in their stores since 1996. In fact, in 1996 plastic bags were replaced by reusable and recyclable alternatives which customers have to buy, however, these bags may be exchanged free of charge if they degrade (E.Leclerc, 2016).</p>
Germany	Voluntary	2016	In April 2016, a voluntary agreement between the German Trade Association and the Federal Ministry of the Environment was signed. Its objective consists of ensuring that within two years of implementation, customers would have to pay for at least 80% of plastic bags in the country. The agreement came into force in July 2016 with over 300 companies involved (German Trade Association, 2016).
Greece	Levy	2018	In August 2017, the government committed to imposing a fee on single-use plastic bags. Starting January 1 st , 2018 plastic bags with a wall thickness of less than 50 microns will cost 0.04USD. This fee will increase to 0.08USD on January 1 st , 2019. However, plastic bags intended for hygiene purposes are excluded from this charge (Hellenic Government, 2017).
Hungary	Voluntary	N/A	Hungarian supermarkets voluntarily charge for plastic bags (Balch, O., 2014)
Iceland	Voluntary/ Action plan	2016	An action plan to reduce plastic bag consumption is in place for the period of 2016-2018. In the beginning stages of the plan, retailers will be encouraged to charge for plastic bags. However, the goal is to establish a law which would prohibit the free distribution of plastic bags by January 1 st , 2019 (Icelandic Environment Ministry, 2016).

Ireland	Levy	2002	To mitigate the impacts associated with plastic bags in the country, the government published the Waste Management (Environmental Levy) (Plastic Bag) Regulations, 2001. This legislation required that beginning March 4 th , 2002, a mandatory 0.18USD levy shall be applied on plastic bags in or at any store, supermarket, service station or other outlets (Dempsey, N., 2001). Within a few months, plastic bag consumption had decreased by more than 90% and the levy has since then increase to 0.26USD per bag (Rosenthal, E., 2008).
Italy	Ban	2014	Italy first tried to ban non-biodegradable plastic bags in 2007, but court contests and manufacturer protest delayed the implementation until 2012 (Smith, C., 2013). However, in 2012, the previous decree was modified to include sanctions and was finally implemented in August 2014 (Italian Chamber of Deputies, 2016).
Latvia	Voluntary; Levy (Expected)	2008	Since 1991, Latvia has a Natural Resources tax imposed on several types of resources to promote well-considered use of these resources. Since 2008, plastic bags have been subject to this tax (European Environment Agency, 2011). Since then, supermarkets have voluntarily started to charge their customers for these bags (Earth Policy Institute, 2014). In accordance with EU Directive 2015/720, the Latvian government expects to prohibit free distribution of plastic bags nationwide by 2018 (Eglitis, 2016).
Lithuania	Levy	2018	In June 2016, the Ministry of Environment of the Republic of Lithuania announced that amendments to the Law on the Management of Packaging and Packaging Waste had been adopted by the Parliament. These amendments prohibit as of December 31 st , 2018, the free distribution of lightweight plastic bags, between 15 and 50 microns thick (Ministry of Environment of the Republic of Lithuania, 2016).
Luxembourg	Levy	2018	In March 2017, a new law was passed in Luxembourg which prohibits the free distribution of all plastic bags as of December 31 st , 2018, except for thin bags used for hygiene purposes (Luxembourg Environnement et Gestion de l'Eau, 2017).
Macedonia	Levy	2009	In 2009, the free distribution of plastic bags was outlawed nationwide. Customers reportedly pay 0.02USD for a bag (Earth policy Institute, 2014).

Malta	Levy	2009	In 2009, Malta initiated an eco-tax of 0.18USD per bags on all plastic bags, i.e. non-biodegradable and biodegradable (Xuereb, M., 2009). In their 2016 budget alert, it was announced that the tax on plastic bags will now be an excise tax to restrict more strongly the use of plastic bags and ensure that the tax is paid. Effective since October 15 th , 2015, plastic bags with a wall thickness superior to 15 microns are taxed at no less than 0.18USD per bag (Malta Chamber of SMEs, 2016).
Moldova	Levy; Ban (in progress)	2017; 2018	On January 1 st , 2017 a ban on the free distribution of plastic bags in the country was implemented. Under the new legislation, retailers must offer environmentally-friendly alternative to their customers, such as labeled biodegradable bags (Ministry of Environment, 2017-A). In July 2017, a new law was approved to gradually phase-out plastic bags from the market. According to this new legislation, small and medium-sized retailers will need to comply with the law by January 1 st , 2018, whereas larger retailers would have until 2020 to comply (Ministry of Environment, 2017-B).
Monaco	Ban	2016	A ban on plastic bags has been implemented since July 2016. This ban is two-fold. Lightweight plastic bags, those between 15 and 50microns thick, were the first to be banned in July 2016. The second stage of the ban came into effect in January 2017 and adds very-lightweight single-use plastic bags to the ban. These are the bags used for carrying fruits, vegetables, meat, fish, etc. (Legimonaco, 2017).
Netherlands	Levy	2016	As of January 1 st , 2016, all plastic bags, except those less than 15micorns thick used as hygiene purposes, are banned from being distributed free of charge. This ban also applies to biodegradable or bio-based plastic bags. Shopkeepers are free to fix their price, but the government suggested a 0.30USD fee. Many supermarkets charge this amount (Government of the Netherlands, 2015).
Northern Ireland	Levy	2013	In 2013, a levy on all single-use carrier bags was implemented. These include plastic bags less than 50 microns thick. The 0.07USD levy applies to carrier bags with a retail price below 0.27USD regardless of what they are made from, to ensure that cheap reusable bags are also charged so that customers are encouraged to reuse bag to their full potetntial. Proceeds from the charge go to

			the Department of Agriculture, Environment and Rural Affairs who in turn use the money collected towards local projects to improve the environment (Statutory Rule of Northern Ireland, 2013).
Norway	Voluntary	N/A	Following the EU Directive 2015/720, Norway attempted to get an exemption from this new directive, stating that plastic bag pollution was not a problem, as most are used as bin liners (Norway Environment Agency, 2015). However, under the European Economic Area agreement, Norway is obliged to follow the directive. Therefore, in 2016 the Norwegian Environment Agency recommended that a high fee should be implemented to stimulate reduced consumption (Norway Environment Agency, 2016). However, Norwegian supermarkets have already been charging a 0.12USD fee on plastic bags for many years. For this reason, supermarket chains are trying to prevent the governments proposed tax in fear that the fee will have a negative impact on consumers. Instead, they are proposing to implement a voluntary agreement in which supermarkets continue to charge 0.12USD for their bags, but the proceeds will go to an environmental fund. The proposition is under review to assess if it meets the EU requirements (Wijnen, P., 2017).
Poland	Levy	2010 (Failed); 2019	A 0.11USD tax on plastic bags was considered in 2012, but it was eventually dropped (Earth Policy Institute, 2014). However, in July 2017, the Ministry of the Environment announced that it has a plan to reduce plastic bag consumption and expects to impose a tax on lightweight plastic shopping bags. This ban on free plastic bags would be effective as of January 1 st , 2019. (Poland Ministry of the Environment, 2017). The announcement followed a warning by the European Commission made in June 2017 urging Poland to enact EU Directive 2015/720 (European Commission, 2017).
Portugal	Levy	2015	In January 2015, a Green Tax was implemented on the national territory of Portugal. Plastic bags less than 50micron thick are subject to this tax, which requires consumers to pay a 0.10USD fee for each plastic bags used (Ministerios das Financas e do Ambiente, do Ordenamento do Territorio e Energia, 2014).

Romania	Levy; Ban	2009; 2018	<p>In 2009, a 0.05USD eco-tax was introduced to encourage behavioural changes in consumers. In 2010, a decision was made to decrease the tax to 0.03USD per bag, which resulted in an increase in plastic bag use, although the proceeds from the tax remained the same (Breniuc, I., 2015).</p> <p>In October 2017, the Romanian government enacted the EU Directive 2015/720 by adopting a draft bill to ban plastic bags less than 50 microns thick in all stores and supermarkets as of July 1st, 2018 (Romania Journal, 2017).</p>
Scotland	Levy	2014	In October 2014, the Scottish Parliament passed legislation requiring all retailers to charge a minimum of 0.07USD for every single-use carrier bags distributed to their customers. These include plastic bags less than 50 microns thick (Scottish Statutory Instruments, 2014).
Slovakia	Levy	2017	On March 2017, the Slovak Parliament voted in favor of an amendment to the Waste Act, which would prohibit the free distribution of plastic bags. Shops reportedly already charge 0.06USD to 0.11USD per bag, but the amendment would require all those who do not already charge, to do so (The Slovak Spectator, 2017).
Slovenia	Levy	2019	At their 142 nd Government Session, the government adopted the Decree amending the Decree on the Management of Packaging and Packaging waste, which include measures to reduce the consumption of lightweight plastic bags (Government of the Republic of Slovenia, 2017). These measures include a ban on the free distribution of all plastic bags by January 1 st , 2019 (Svet Kapitala, 2017).
Spain	Levy	2018	According to the Royal Decree Draft for the reduction of plastic bag consumption and for which is created a registry of producers published on July 25 th , 2017, free distribution of plastic bags will be prohibited as of March 2018. The government suggests fees between 0.06USD and 0.18USD depending on the thickness of the bag. The decree also adds that as of January 2020, lightweight and very-lightweight plastic bags will be banned. The ban however does not apply to bags made with compostable plastics as well as plastic bags with a wall thickness equal to or greater than 50microns made from at least 30%

			recycled plastic (Ministerio de Agricultura y Pesca, Alimentacion y Medio Ambiente, 2017).
Sweden	Voluntary	2014	In 2014, Coop, a grocery retail group replaced oil-based plastic bags with two more environmentally-friendly options, which they charge: plastic bags made of recycled plastic and those made of sugar cane (Hartford, S., 2017). Due to a new national policy which requires stores to inform their customers about the environmental impacts posed by plastic bags, starting June 2017, Coop has also developed a poster informing customers about these impacts. The poster is on display in all their stores (Coop, 2017). In the retail sector, three large stores – H&M, KappAhl, Lindex - have initiated the “One Bag Habit” campaign, which requires stores to charge for shopping bags (plastic and paper), and donate the proceeds to environmental or sustainable development projects. Stores are also required to report their earnings and where they have gone as well as provide more durable bags to their customers. The Initiative started on June 1 st , 2017 and has at least a dozen companies participating (One Bag Habit, 2017).
Switzerland	Voluntary	2018	In 2012, the Swiss Parliament attempted to ban the distribution of single-use plastic bags. Unfortunately, the ban was waived in 2016 due to legal reasons (Niaounakis, M., 2017). However, in June 2016 the Parliament announced that it had reached an agreement with retailers to start charging for single-use plastic bags no later than 2018. This agreement only applies to retailers who offer food supplies (Agence Telegraphique Suisse, 2016).
Wales	Levy	2011	Since October 2011, there has been a minimum 0.07USD charge on all single use carrier bags in Wales (Welsh Statutory Instrument, 2010).
North America			
Antigua and Barbuda	Ban	2016	As of July 1 st , 2016, a ban on the importation and use of single-use plastic bags has been implemented in Antigua and Barbuda (United Nations Environment Programme, 2017). As an effort to encourage the use of reusable shopping bags, the government pledged to distribute 120,000 bags across the country as well as educate the public on the benefits of ban. The government also decided to waive taxes and duties on the importation of reusable shopping bags to encourage supermarkets to support the initiative. Therefore, major supermarkets have also

			decided to distribute one reusable, environmentally friendly bag per customer (Business Focus Antigua, 2016).
Aruba	Ban	2017	In late June 2016, the Aruba Parliament unanimously voted for a ban on single-use plastic bags. The ban came into effect on January 1 st , 2017 (Prime Minister of Aruba, 2016). This ban prohibits the distribution and sale of plastic bags intended for single-use (Carvalho, J.D., 2016).
Barbados	Voluntary	2017	The Future Centre Trust, a local NGO focused on environmental awareness attempted to convince the government to establish regulations to reduce plastic bag consumption in the country, but were unsuccessful (de Verteuil, M., 2017). However, they persevered and established a voluntary agreement between retailers and NGOs in which reusable bags are made available and plastic shopping bags cost 0.08USD (Future Centre Trust, 2017). The initiative came into force on June 1 st , 2017 and hopes to decrease consumption by 85% in the first six months (Smith, C., 2017).
Canada	Voluntary	2007	There is no national law pertaining to plastic bag reduction in Canada. However, many retailers and supermarkets have taken it upon themselves to decrease the amount of single-use plastic bags offered to their clients. For example, in 2007 IKEA Canada introduced their 'Bag the Bag' program in an effort to reduce plastic bag consumption by 50% in one year. The IKEA reusable Blue Bag was available for 0.80USD and plastic shopping bags for 0.04USD. The initiative was so successful that in the first 6 months plastic bag consumption decreased by 90% and IKEA decided in 2009 to eradicate completely the single-use plastic bags from their stores (IKEA Canada, 2009). Another voluntary initiative came in 2009, when Loblaws Companies Limited, one of Canada's largest food and pharmacy group, decided to charge 0.04USD per single-use plastic bags in their stores nationwide (World Wildlife Fund Canada, 2009). A more recent initiative came when Walmart Canada decided in 2016 to stop providing free plastic bags to their customers (Walmart Canada, 2016).
Costa Rica	Ban	2017	On June 5 th , 2017 Costa Rica launched a national strategy to reduce consumption of all single-use plastics, not just plastic bags. Their goal is that by 2021, Costa Rica will be the first country in the world with a comprehensive national

			strategy to eliminate single-use plastics. The Costa Rican Minister of Environment and Energy therefore calls upon all sectors to commit to this initiative through five strategic actions: municipal incentives; replacement of single-use plastic products; research and development; policies and institutional guidelines for suppliers; as well as investment in strategic incentives (Gutierrez, Anchia, and Shackelford, 2017).
Panama	Ban (In progress)	2017	In April 2017, a law which would prohibit the use of plastic bags as well as promote the use of reusable alternatives was proposed at the National Assembly. Once implemented, it would require supermarkets, retailers, and pharmacies to gradually phase-out their plastic bags within 12 months, whereas wholesalers and warehouses would be given 24 months (Fanovich, Gozaine & Aleman, 2017). On April 10 th , 2017, the Panama National Assembly approved the law, however, the date of implementation is yet to be revealed (Chamorro, P.J, 2017).
United States	Voluntary	2008	The United States does not have federal regulations pertaining to the reduction of single-use plastic bags. However, some supermarkets and retailers have initiated voluntary measures. For instance, in January 2008, Wholefoods Market, a nationwide organic and natural foods supermarket announced that it will stop providing disposable plastic bags to their customers in all their stores including Canada and the United Kingdom (Whole Foods Market, 2008). IKEA also decided in 2008 to only offer reusable bags at checkouts in all their stores in the country (IKEA, 2008).
Oceania			
Australia	Voluntary	2017	The Federal Government does not have a formal Ministerial Council structure in place to make decisions on environmental issues, including plastic bag pollution (Western Australia Local Government Association [WALGA], 2016). Hence, there is no national law pertaining to single-use plastic bags. However, Australia's two largest supermarket chains, Woolworths and Coles have taken it upon themselves to reduce the use of single-use plastic bags in the country. On July 14 th , 2017, Woolworths Group announced that it will be phasing-out single-use plastic bags within the next year in all their stores nationwide. Customers will still have access to a range of alternative bags at different price points

			(Woolworths Group, 2017). A few hours after the announcement by Woolworth, Coles also announced that they will be phasing-out single-use plastic bags in the next 12 months (Slezak, M., 2017).
Cook Islands	Ban	2012	In September 2012, the importation of non-biodegradable plastic bags was banned under the Prohibition on Importation of Plastic Shopping Bags Regulation 2012. Organizations must now apply for a permit to import bags which biodegrade within 12 to 18 months (Cook Islands News, 2012).
Fiji	Levy	2017	Following the United Nations Ocean Conference from June 5 th to 9 th 2017, the Fijian Government pledged to reduce the use of plastic bags and more effectively reduce plastic waste (Fiji Department of Environment, 2017). Shortly after, the Environmental Levy (Budget Amendment) Act 2017 proposed to impose a 0.05USD levy on plastic bags. This act came into force on August 1 st , 2017 (Fiji Bill No.°29 of 2017).
Marshall Islands	Ban	2016	In 2016, the Styrofoam Cups and Plates, and Plastic Products Prohibition, and Container Deposit Act 2016 was proposed. This act seeks to “ban the importation, manufacturing, sale or distribution of Styrofoam cups and plates, disposable plastic cups and plates and plastic shopping bags” (Republic of Marshall Islands, 2016). The act was passed on September 29 th , 2016, came into effect in February 2017 and aims to encourage retailers to issue recycled paper bags or reusable shopping bags which are not plastic.
New Zealand	Voluntary	2009	Support for a levy or ban on plastic bags is widespread throughout the country. However, the central government has not implemented regulations in this regard and does not allow local decision making on the issue (BYO Bag, 2017). For this reason, voluntary initiatives have started to emerge. For instance, in 2009, The Warehouse Group, the largest retail group in the country started charging 0.07USD per plastic shopping bag as part of their ‘Bags for Good’ campaign which aims to reduce plastic bag consumption as well as help local charities (The Warehouse, 2016). Foodstuffs Ltd, a grocery cooperative encourages the use of reusable bags by offering a rebate to customers who arrive with such bags. They also charge for plastic bags in their PAK’n’SAVE stores (Foodstuffs, 2017). In 2015, the grocery retailer Countdown became a founding

			member of the ‘Soft Plastic Recycling Programme’, an initiative that encourages customers to recycle soft plastics in specially marked bins (Countdown, 2017). This initiative includes 46 partners who have helped collect over 100 tonnes of soft plastic (25 million bags) in 2016 (Soft Plastic Recycling, 2017).
Palau	Ban	2017	On August 4 th , 2017, the Palau House of Delegates passed a bill to ban the importation and distribution of plastic bags. The law is set to take effect in the next two years and also seeks to educate the public on the destructive effects of plastic bags (Island Times, 2017).
Papua New Guinea	Ban	2016	On January 1 st , 2016, non-biodegradable plastic bags were banned in Papua New Guinean supermarkets. The ban was implemented by the Conservation and Environment Protection Authority (Scuiller, L., 2016).
Vanuatu	Ban	2017	Prime Minister Charlot Salawi announced on July 30 th , 2017 that the government will be phasing-out single-use plastic bags and bottles. When fully implemented, the ban would prohibit the importation and use of single-use plastic bags and bottles (Cunningham, M., 2017).
Brazil	Ban (Proposed/ Failed)	2007	In 2007, a bill was proposed at the national congress which aimed to encourage biodegradable plastic bags, and henceforth ban non-biodegradable plastic bags. The bill suggested that oxy-biodegradable plastic bags were made compulsory in all commercial establishments on the national territory. This bill, however, did not pass (Projecto de lei No.º612, 2007).
Colombia	Ban & Levy	2016	In 2015, Colombia passed a law which aimed to gradually reduce the consumption of single-use plastic bags. The law seeks to eliminate the use of these bags by 80% by 2020 and completely by 2025 (Congreso de la Republica de Colombia, 2015). In April 2016, however, a new law was put forward to strengthen its predecessor. With this new regulation in place, plastic bags with a wall thickness below 23 microns and with an area smaller than 30cm x 30cm are banned as of December 31 st , 2016 (Republica de Colombia, 2016). Finally, as of July 1 st , 2017 a tax was imposed on all plastic bags. The bags will cost 20 pesos

			(0.007USD) in the first year of implementation and increase by 10 pesos (0.003USD) every following year (Actualicese, 2017).
Guyana	N/A	2017	In April 2017, the Ministry of Communities published their National Integrated Solid Waste Management Strategy for the Cooperative Republic of Guyana 2017-2030, in which they state that the government will develop cost-effective legislative measures to reduce the consumption of single-use plastic bags and encourage the use of less wasteful alternatives.
Paraguay	Ban & Levy	2017	On July 30 th , 2016, the Ministry of Industry and Commerce published decree no.º 5537 which requested that Law No.º 5414/2015 be regulated. This law promoted the gradual replacement of single-use plastic bags with reusable or biodegradable alternatives. The request was approved and as of April 2017, costumers must pay for their shopping bags. The price varies depending on the size of the bag. Single-use plastic bags must also be reduced by 50% by the end of 2018 and completely by the end of 2019 (Presidencia de la Republica del Paraguay, 2017).
Peru	Bans (Failed); Levy (Failed)	2012, 2013, 2014	Laws were proposed in 2012, 2013 and 2014, however, none of these propositions were enacted. In October 2012, the proposed law No.o1638/2012-CR emphasized the gradual replacement of single use plastic bags with more sustainable alternatives (Cusi, R.C., 2012). A year later, in November 2013, a similar law was proposed. The proposed law No.º2967/2013-CR seeked to promote the use of biodegradable bags by gradually phasing-out non-biodegradable alternatives (Valqui Matos, N.A., 2013). Finally, in March 2014, law No.º3208/2013-CR proposed to commercialise single-use plastic bags (Villacorta, C.T., 2014).
Uruguay	Levy	2017	According to a press release published on February 23 rd , 2017 by the United Nations Environment Programme, Uruguay has joined the #CleanSeas campaign and plans to tax single-use plastic bags by the end of the year. However, no news on the subject has been released since.

Appendix B: Worldwide Regional Initiatives

Country	State/Province/ Region	Type	Year	Details
Africa				
South Africa	Western Cape	Ban & Levy	2017	In October, a motion regarding the reduction of plastic shopping bag waste was passed. According to this motion, plastic bags with handles must now be 100% recyclable, be made with 100% recycled post-consumer waste, and contain 1.5% biodegradable additive to render them fully biodegradable under appropriate aerobic or anaerobic conditions. The motion also mandates that the province pass legislation to give effect to a provincial levy on plastic shopping bags (Vos, J., 2017).
Asia				
India	Goa	Ban	2002	Plastic bags below 40 microns thick have been banned in Goa since September 2002 (Government of Goa, 2002). However, in July 2017, in an effort to tackle the garbage and litter problem in public places, the government of Goa extended the ban to plastic bags less than 50 microns thick (Kamat, P., 2017).
	Himachal Pradesh	Ban	2003	Himachal Pradesh banned plastic bags less than 30 microns thick (Mishra, A., 2017).
	Karnataka	Ban	2016	On March 11 th , 2016, the government issued an official gazette notification stating that all plastics, regardless of thickness will be banned across the state. This includes a ban on products such as plastic plates, plastic cups, plastic spoons, and plastic carry-out bags (Moudgali, S., 2016).
	Maharashtra	Ban	2015	A ban on plastic bags less than 50 microns thick became effective in February 2015. Strict punishments to force compliance were announced due to an earlier ban that did not work due to poor implementation (The Indian Express, 2015).

	Punjab	Ban	2016	A ban on plastic bags in urban areas of the Punjab state has been in effect since April 1 st , 2016. The regulation prohibits the production, distribution, purchase and sale of these items (Hindustan Times, 2016),
	Rajasthan	Ban	2010	Since August 2010, the manufacture, storage, import, sale and transport of plastic shopping bags has been banned in India's largest province. Therefore, no retailer, trader, vendor or shopkeeper is allowed to supply goods to consumers in these bags (Young, T., 2010).
	Uttarakhand	Ban	2017	Since January 11 th , 2017, a total ban on the sale, use and distribution of plastic bags, cups, glasses and packaging material has been in effect in the state of Uttarakhand (Budhwari, Y., 2017).
	Uttar Pradesh	Ban	2015	A complete ban on the use of plastic bags in the state was issued on December 31 st , 2015. The ban prohibits the manufacturing, importing, purchasing and storage of all kinds of plastic carry-out bags (India Today, 2015).
Indonesia	Bali	Voluntary; Ban	2013; 2018	Two young Balinese sisters, Melati and Isabel Wijsen, founded the Bye Bye Plastic Bags Initiative in 2013. This youth driven initiative has become a well-known movement of inspiration and empowerment worldwide. In 2015, they launched the One Island One Voice campaign which highlights the efforts of plastic bag free shops, restaurants, hotels, etc. by marking them with a "One Island One Voice – Plastic Bag Free Zone" sticker and by using a name and shame technic. The initiative has also resulted in a commitment by the Bali government to become plastic bag and plastic garbage free by January 2018 (Bye Bye Plastic Bags, 2017)
Japan	Aichi-Ken	Voluntary	2007	In November 2007, shops introduced a plastic bag reduction initiative. Shops participating in the initiative agreed to reduce their plastic bag distribution by 50% in three years. Businesses that reached their target were given an award and their efforts were named "Excellent shopping bag reduction initiatives". Out of the 347 shops participating by December 2011, 321 were awarded the "Excellent shopping bag reduction initiative" award (Japan Ministry of Environment, 2015)
	Akita	Voluntary	2017	An agreement was reached between the Akita government and business operators in the prefecture to implement measures to reduce plastic shopping

				bags. Businesses are free to decide which kind of measure they wish to use in their stores. Over 600 stores have implemented some kind of measure which range from giving store points for customers that use their own bags to banning the free distribution of plastic bags (Akita Prefectural Government Office, 2017).
	Aomori	Voluntary	2009	In 2009, an agreement was reached between the Aomori government and major supermarkets throughout the prefecture to stop providing plastic bags free of charge to their customers. Following this initial agreement, the government was able to reach five other agreements with different businesses, which has resulted in a total of 296 stores which have banned the free distribution of plastic bags (Aomori Prefecture Government, 2017).
	Ehime	Voluntary	N/A	Awareness campaigns were established throughout the prefecture to reduce plastic bag consumption and promote an eco-friendly shopping habit. Shops which promote these campaigns and are excellent recycle-oriented models are certified Eco-Shops (Japan Ministry of Environment, 2015)
	Fukushima	Voluntary	2009	In April 2009, an agreement was signed with businesses, consumer groups and local governments to stop providing free plastic bags to consumers. Participating stores are registered as earth-friendly Fukushima shops (Japan Ministry of Environment, 2015).
	Gifu	Voluntary	2007	Businesses, consumer groups and municipalities agreed through a voluntary program to stop providing free plastic bags to customers (Japan Ministry of Environment, 2015).
	Hiroshima	Voluntary	N/A	Businesses, consumer groups and municipalities agreed through a voluntary reduction program to implement a ban on the free distribution of plastic bags (Japan Ministry of Environment, 2015).
	Hokkaido	Voluntary	2008	In 2008, activities by consumer groups, businesses and local governments resulted in the formation of a reduction committee who banned the free distribution of plastic bags throughout the prefecture based on an agreement between participating groups (Japan Ministry of Environment, 2015).

Hyogo	Voluntary	2007	In June 2007, following a study of plastic bag reduction measures in the prefecture, the Hyogo plastic bag reduction meeting was established between governmental entities, businesses and consumer groups. By January 2008, the Hyogo action guidelines for the promotion of plastic bag reduction were established. These guidelines resulted in an awareness campaign for customers to bring their own bags as well as reduction targets for participating businesses (Japan Ministry of Environment, 2015).
Iwate	Voluntary	2012	The Iwate prefecture government implemented an Eco-Shop certification program which recognizes stores that are working towards waste reduction, including plastic bag reduction efforts. They also implemented a governor commendation for excellent efforts and stores with high effectiveness (Japan Ministry of Environment, 2015).
Kanagawa	Voluntary	2009	An agreement was reached between various organization such as businesses and consumer groups to reduce plastic bag consumption in the prefecture. The agreement resulted in the implementation of various shopping bag reduction and promotional awareness campaigns as well as a planning and reporting system related to shopping bag reduction by business operators (Japan Ministry of Environment, 2015).
Mie	Voluntary	2007	Due to a tripartite agreement between businesses, municipalities and consumer groups, participating businesses do not provide free plastic bags to their consumers (Japan Ministry of Environment, 2015).
Nara	Voluntary	N/A	The Nara government supports local initiatives to reduce plastic bag consumption through awareness campaigns (Japan Ministry of Environment, 2015).
Oita	Voluntary	2009	In 2009, an agreement to ban the free distribution of plastic shopping bags was signed by businesses, consumer groups, and local governments. As of February 2013, 31 businesses divided into 224 stores were participating in the agreement throughout the prefecture (Seguchi, R. & Hotta, Y., 2013).
Okinawa	Voluntary	2008	An agreement was reached between the Okinawa government and businesses to reduce the distribution of plastic bags. The agreement resulted in 257 stores

				banning the free distribution of plastic shopping bags. Stores charge 0.03USD per bag and promote reusable bag use (Japan Ministry of Environment, 2015).
	Tottori	Voluntary	N/A	A campaign was established to stop providing plastic shopping bags on the 10 th of every month. The campaign also calls for reducing plastic bag consumption through public awareness as well as store privilege systems where customers are rewarded for bringing their own bags or not taking a plastic bag. Rewards include, but are not limited to, store points and cash back systems (Japan Ministry of Environment, 2015)
	Toyama	Voluntary	2008	The Toyama Plastic Bag Reduction Council, consisting of members from businesses, consumer groups, local governments and others, reached an agreement to reduce plastic bag consumption in the entire prefecture by banning the free distribution of these bags (Japan for Sustainability, 2008).
	Yamaguchi	Voluntary	2009	The Yamaguchi Prefecture Container Packaging Waste Reduction Promotion Council, which consists of businesses, consumer groups and local governments, has been developing since April 2009 awareness campaigns for the reduction of plastic bags. 1110 stores have also stopped providing free plastic shopping bags to their customers (Japan Ministry of Environment, 2015)
	Yamanashi	Voluntary	2008	Businesses, consumer groups and local governments actively encourage customers to bring their own bags when shopping through awareness campaigns. Businesses participating in the tripartite agreement also implement initiatives such as bans on free plastic bags to reduce consumption of these items (Japan Ministry of Environment, 2015).
Malaysia	Federal Territories (Wilayah Persekutuan)	Ban	2017	September 1 st , 2017 marked the start of a ban on conventional plastic shopping bags. Plastic bags provided to customers at the point of sale must now be biodegradable or compostable (The Straits Times, 2017).
	Johor	Ban	2017	Starting July 1 st , 2017, all hypermarkets and supermarkets in the state of Johor were required to replace all conventional plastic shopping bags with biodegradable alternatives. This is a first step towards making Johor plastic and polystyrene free starting January 1 st , 2018 (The Star, 2017-A).

	Malacca (Melaka)	Ban	2016	In January 2016, a ban on shopping bags in all supermarkets and shopping malls in the state took effect. Consumers are therefore required to bring their own bags or accept biodegradable alternatives at checkout areas. For a year before the ban took effect, the government had been providing information on the initiative through various announcements (The Star, 2016-A).
	Penang (Pulau Pinang)	Levy	2009	In July 2009, Penang launched the “No Free Plastic Bag” campaign where stores charged for plastic bags once a week. However, in 2011, the charge was extended to everyday, of every week, for the whole year. Now, all hypermarkets, supermarkets, restaurants, pharmacies, convenience stores and smaller businesses must charge 0.05USD per bag (Pulau Pinang State Government, 2011).
	Perak	Ban (postponed)	2017	A statewide ban on plastic bags and polystyrene containers was intended to take effect in June 2017, however, the ban was postponed until a full study could be concluded. The ban cannot take effect before proper alternatives could be identified and an environment that leads toward the ban is created (The Star, 2017-B)
	Sabah	Voluntary	2010	In 2010, the Sabah a voluntary initiative known as the “No Plastic Bag” campaign was launched. Participating stores charge 0.05USD for plastic bags on Saturdays, Sundays and Mondays. However, in 2015 the use of the funds collected were questioned and the initiative was scrapped. The campaign has recently been relaunched in August 2017 (The Star, 2017-C; Sabah Ministry of Tourism, Culture and Environment, 2017).
	Selangor	Levy	2010	Since 2010, consumers, on Saturday’s, are required to bring their own bags to stores or pay a 0.05USD fee per plastic bags. As of January 2017, the initiative was extended to everyday of the year (The Star, 2016-B)
Pakistan	Balochistan	Ban	2017	In an effort to protect the environment, the Balochistan Assembly passed a resolution to ban the sale, use and production of plastic bags. The ban took effect on May 15 th , 2017 (Rehman, D., 2017).
	Islamabad Capital Territory	Ban	2013	A ban on the manufacture, sale and use of non-degradable plastic products, which include plastic shopping bags, was published in the Pakistan Official Gazette in January 2013. The ban took effect on April 1 st , 2013 and is known

				as the “Prohibition of Non-degradable Plastic Products (manufacturing, sale and usage) Regulations 2013” (Government of Pakistan, 2013).
Philippines	Albay	Ban	2012	In February 2011, the Albay Governor signed into law a ban on the use of plastic bags, Styrofoam and other synthetic materials. A one-year moratorium was granted to shop-keepers so they could prepare for the ban which took effect on June 1 st , 2012. Consumers are now encouraged to use reusable or recyclable bag alternatives such as “bayongs”, which are native woven bags, or paper bags (Duboise, T., 2012).
	Bulacan	Ban	2012	The sale and use of non-biodegradable plastic bags have been banned in the province of Bulacan since April 2012 (Provincial Government of Bulacan, 2012).
	Cavite	Ban	2012	In April 2012, a provincial ordinance was approved, which gives detailed prohibitions and regulations for the use of plastic for goods and commodities. For example, all commercial establishments are required to only use eco-friendly bags in all aspects of their business. Consumers are also instructed to bring appropriate containers whenever they go to the market. The ordinance also requires schools to teach their students how to make bags out of recyclable and environmentally friendly materials (Republic of the Philippines, 2012).
	Guimaras	Ban	2014	The Anti-Plastic Ordinance of 2014 of the Province of Guimaras prohibits grocery stores, souvenir shops, boutiques, street or market vendors as well as ambulant vendors to provide plastic bags to their customers. Instead, they must provide either sturdy reusable paper bags or cloth bags, or paper pouches, depending on the number of items purchased, to their customers free of charge. The ordinance also requires any person engaged in business, operating commercial establishments, to minimize their use of plastic bags (Republic of the Philippines, 2014).
United Arab Emirates	Ajman	Ban	2010	In June 2010, Ajman became the first Emirate to ban plastic bags in the UAE. Following the implementation of the ban, 90% of targeted commercial outlets and factories stopped producing non-biodegradable bags. A campaign called ‘Day Without Plastic Bags’, which has been organized since 2011, has also

				helped to reduce the dependence on plastic bags (Landais, E., 2010; Abdullah, A., 2015)
Europe				
Belgium	Brussels	Ban	2017	A ban on lightweight single-use plastic bags at checkouts has been in effect since September 2017. The ban will extend in September 2018 to plastic bags used before getting to the checkout counter. Hygiene bags used for fruits and vegetables will be allowed, however, they must be made with at least 40% bio-sourced materials and must be compostable. The percentage will raise to 60% in 2025 (Buxelles Environnement, 2017).
	Wallonia	Ban	2016	Since December 2016, lightweight single-use plastic bags have been banned at checkouts in the region of Wallonia. In March 2017, the ban was extended to all other plastic bags used before checkout, such as those used when buying in bulk (Portail de la Wallonie, 2017).
France	Corsica	Ban	2003	In 1999, an information and awareness campaign was launched by the founders of the Calvi Wind Festival to reduce the use of plastic bag on the island. Four years later, the Corsica population was invited to vote, through a referendum, on which alternatives should be provided to replace plastic bags. The referendum was adopted by the whole population. Therefore, since 2003, only tote bags and paper bags are offered to customers at supermarket checkouts (Orru, Boyer and Jaraudias, 2005).
	Mayotte	Ban (failed)	2006	The Mayotte General Council decided in 2004 to restrict the use of plastic bags on their islands. Therefore, a ban came into effect on January 1 st , 2006. However, due to difficulties finding substitutes and a lack of enforcement, plastic bags continued to flourish (Ali, C., 2016; Les Naturalistes de Mayotte, 2014).
Portugal	Azores	Levy	2016	The Regional Legislative Decree no. 13/2015/A was passed in April 2015 as an effort to reduce the use of plastic shopping bags in the Autonomous Region of the Azores. Therefore, since April 2016, an eco-tax of 0.05USD is charged to customers in all large commercial areas for every plastic bags. The tax was extended to all other retail establishments in April 2017 (Government of the Azores, 2017).

Spain	Andalucia	Levy	2011	Since May 2011, there has been a tax on single-use plastic bags in Andalucia. The tax is currently set at 0.06USD, but it is expected to increase to 0.12USD in 2018. All retail outlets must pass on the full amount of the tax to their consumers. Reusable and biodegradable bags are exempt from this tax, as well as plastic bags used for hygiene purposes (Consejería de Hacienda y Administración Pública, 2017).
	Cantabria	Levy (Repealed)	2011	A tax on single-use plastic bags came into effect on January 1 st , 2011. The tax imposes a 0.06USD fee on every bag used at checkouts. However, plastic bags used for hygiene purposes and reusable bags are exempt from the tax. (Gobierno de Cantabria, 2010). The tax was repealed on December 31 st , 2017 (Gobierno de Cantabria, 2011).
	Catalonia	Voluntary; Levy	2008; 2017	In 2006, meetings were underway between the Waste Agency of Catalonia and representatives of Catalan and Spanish distribution associations to prevent the generation of single-use plastic bags. These meetings led to two individual agreements in 2008 with XarxaFarma and BonPreu Group who pledged to reduce their consumption of single-use plastic bags by 20% by 2010. Finally, in 2009, the Plastic Bag Agreement was signed between the Catalonia Waste Agency and eleven associations. The pact was valid for two years with the aim to reduce by 50% the consumption of plastic bags by 2012 (Gallo, F., 2016; Vara, A., 2013). Most recently, the Catalonia Waste Agency reached an agreement with the commercial sector under which plastic bags shall not be provided free of charge to consumers. This agreement is regulated by law 5/2017 of March 28 th , which came into effect on March 31 st , 2017. According to this law, there is no minimum or maximum fee that retailers must charge (Agencia de Residus de Catalunya, 2017).
North America				
Canada	Alberta	Voluntary	2009	In 2010, the Retail Council of Canada (RCC), the Canadian Federation of Independent Grocers (CFIG), the Canadian Association of Chain Drugstores (CACDS) and the former Canadian Council of Grocery Distributors (CCGD),

				which was dissolved in 2011, reached an agreement with the Government of Alberta to reduce the consumption of single-use plastic bags. The Alberta Plastic Bag Distribution Reduction Strategy Implementation Plan was implemented to reduce by 30% the consumption of plastic bags by 2011 and 50% by 2013, based on 2008 data. To do so, different initiatives and incentives were used such as encouraging consumers to bring their own bags, providing incentives for consumers to bring their own bags, facilitating customer access to alternative bag options, and training staff to deploy efficient bagging techniques. The Plan covers a five-year period from January 2009 to December 2013 (Retail Council of Canada, the Canadian Federation of Independent Grocers, and the Canadian Association of Chain Drugstores, 2012).
	British Columbia	Voluntary	2008	Similar to Alberta, the RCC, CCGD, CFG and CACDS reached an agreement with the British Columbia government to reduce by 50% the consumption of plastic bags by 2013 through the 3Rs strategy (Recycling Council of British Columbia, 2009; Retail Council of Canada, the Canadian Federation of Independent Grocers, and the Canadian Association of Chain Drugstores, 2012)
	Manitoba	Voluntary	2010	The Manitoba Plastic Bag Reduction Plan was established in 2010 by the Multi-Material Stewardship Manitoba (MMSM) along with staff and stewards from the food, beverage and consumer goods sectors. The plan focused on the 3Rs strategy to cut down plastic bag consumption by 50% by 2015 based on 2007 data. Initiatives linked to this program include education and awareness advertising, promotional events, handing out reusable bags, and school plastic bag challenges. The government plans to continue working with the industry to achieve higher reduction targets by 2020 (Multi-Material Stewardship Manitoba, 2014; Government of Manitoba, 2014).
	Northwest Territories	Levy	2010	The Northwest Territories started imposing a 0.20USD fee on all single-use retail bags in stores across the Northwest Territories in February 2011. However, phase I of this program started in January 2010 and applied only to grocery stores. The fee applies not only to all plastic bags, but also to all paper

				and biodegradable bags. The fee goes towards the Environment Fund, which is used to cover program expenses and help create new waste reduction and recovery programs (Government of Northwest Territories, 2017).
	Nunavut	Voluntary	2011	The Greener Tomorrow Initiative was launched in 2011 to reduce plastic bag consumption in the Nunavut and Nunavik communities. To do so, two free reusable bags were distributed to each household and Northern/NorthMart grocers started to charge a 0.20USD fee for conventional plastic bags. The proceeds from this charge are given back to the community through environmental programs (The Northwest Company, 2013).
	Ontario	Voluntary	2007	In 2007, the Ontario Plastic Bag Reduction Task Group was formed to respond to a government initiative that aimed to reduce plastic bag consumption by 50% in 5 years. The task force was led by the CCGD, the CFG, the RCC, the Recycling Council of Ontario (RCO) and the Canadian Plastics Industry Association (CPIA). The goal of the task force was to build a strong framework based on the 3R's strategy, i.e. Recycle, Reduce and Reuse. The goal was met in only three years, having reached a 58% reduction. According to the task force, key factors contribution to this success included: "increased availability of reusable options like reusable bags and bins, improved bagging practices at check-outs, in-store incentives encouraging reduction and recycling, more in-store collection points for recycling, increased recycled content in plastic bags where possible, and greater consumer awareness of the 3Rs" (Ontario Plastic Bag Reduction Task Group, 2010). Since the end of the initial program, many industries have continued to follow the 3R strategy. For instance, RCO and Walmart Canada join forces each year for the Plastic Bag Grab challenge which is a week-long program that encourages elementary school students to collect plastic bags, bring them to their school and then bring them to their local Walmart's customer service center for recycling. The schools that have collected the most plastic bags are eligible to win prizes (Recycling Council of Canada, 2017).
	Quebec	Voluntary	2008	In 2008, the <i>Conseil québécois du commerce de détail</i> (CQCD) joined forces with the <i>Association des détaillants en alimentation du Québec</i> (A.D.A), the

				CCGD, <i>Éco Entreprises Québec (ÉEQ)</i> and <i>RecycQuébec</i> to adopt the “Voluntary Code of Best Practices for the Use of Shopping Bags”. This code defines twenty measures to be implemented in order to reduce the consumption of single-use plastic bags in the province, such as implementing a charge on single-use shopping bags, offering reusable alternatives, and promote measures and incentives for customers who use their own durable bags or bins (Conseil québécois du commerce de détail, 2017; Association des détaillants en alimentation du Québec, Canadian Council of Grocery Distributors, Conseil Québécois du commerce de détail, Éco Entreprise Québec & RecycQuébec, 2008). The goal was set at reducing the use of plastic bags by 50% by 2012. In 2010, this goal was achieved with a 52% reduction across the entire retail sector (All About Bags, 2012).
Mexico	Aguascalientes	Ban	2010	Article 130 of the law for the environmental protection of the state of Aguascalientes states that to reduce the use and distribution of plastic bags, they must be progressively replaced by degradable and/or biodegradable bags (Gobierno constitucional de Aguascalientes, 2010).
	Baja California	Levy	2016	In February 2016 an initiative to modify article 141 of the state law for the protection of the environment was unanimously approved. The modification states that plastic bags cannot be given out free of charge to customers except for plastic bags which are recyclable, reusable or biodegradable (Presidencia del Congreso del Estado de Baja California, 2016).
	Michoacan	Ban	2013	In March 2013, the law for the sustainable development of the State of Michoacan was published in the state’s official gazette. The law states that plastic bags provided in commercial establishments must be made with materials that are easily degradable (Congreso de Michoacan de Ocampo, 2016).
	Quintana Roo	Levy	2009	Reforms made in November 2009 to the law for prevention and comprehensive management of waste in the state of Quintana Roo prohibits the free distribution of non-biodegradable plastic bags. However, the amount of the charge is not specified (Legislatura constitucional del estado libre y soberano de Quintana Roo, 2015).

	San Luis Potosi	Ban	2014	Since 2009, the Government of San Luis Potosi has attempted to eliminate plastic bag consumption. However, it wasn't until reforms were made to the state's environmental law that plastic bags were officially banned. In fact, reforms made to articles 104 and 107 prohibit the distribution of plastic bags to customers. Instead, reusable or biodegradable bags are suggested (Legislatura San Luis Potosi, 2015).
	Zacatecas	Ban & Levy	2010	According to articles 54 and 55 of the solid waste law for the state of Zacatecas, non-biodegradable plastic bags are prohibited, and biodegradable bags cannot be provided to customers free of charge (Legislatura del Estado de Zacatecas, 2010).
United States	Arizona	Ordinance ban	2016	The Arizona legislature has voted to prohibit local governments from regulating the use of plastic bags. In fact, under House Bill 2131, no city, town or county may impose a tax, fee, charge, or return deposit for auxiliary containers. They also may not regulate the sale, use or disposition of these auxiliary containers. For the purpose of this bill, "auxiliary containers" include reusable bags, disposable bags, boxes, beverage cans, bottles, cups and containers that are made out of plastic, cloth, glass, aluminum, cardboard, extruded polystyrene or other similar materials (State of Arizona, 2016).
	Arkansas	Ban (Failed)	2013	In January 2013, State Representative Denny Altes introduced a House Bill to be known as the "Reusable Shopping Bag Act". If passed, the provision of single-use shopping bags to customers would be prohibited. Neither plastic nor paper bags would be allowed, but stores would need to make reusable bags available for purchase to customers. Unfortunately, the bill died in House Committee at Sine Die adjournment in May 2013 (Arkansas State Legislature, 2013).
	California	Ban & Levy	2016	In November 2016, Proposition 67 was passed, making Senate Bill 270 effective. The bill prohibits stores from providing single-use carryout bags made of plastic, paper or any other material to their customers. The stores may provide reusable bags that are designed for at least 125 uses. If the reusable bag is made of plastic, it must be made by at least 20% postconsumer recycled material, and by 2020, this percentage shall be raised to 40%. Reusable bags

				offered to customers shall not be sold for less than 0.10USD. Paper bags may also be offered to customers if they contain a minimum of 40% postconsumer recycled materials, are accepted for curbside recycling programs, and are sold at no less than 0.10USD (California Legislative Information, 2014; CalRecycle, 2017).
	Colorado	Ban & Levy (Failed)	2009	In 2009, a Senate Bill was proposed to ban plastic bags by 2012 in large retailers. Before then, large retailers were to charge a minimum 0.06USD fee for plastic bags. However, the bill was defeated in February with critics arguing that the ban would lead to an increased use of paper bags which they argued take more energy to produce (Slevin, C., 2009).
	Connecticut	Ban & Levy (Pending) + Recycling	2017	Since early 2017, Connecticut is working to reduce plastic bag consumption. A Bill was proposed to tax single-use carryout paper and plastic bags and eventually phase them out completely. The bill has passed out of the state Senate and is awaiting action in the House (Connecticut General Assembly, 2017). In the meantime, however, Connecticut Department of Energy & Environmental Protection launched a campaign to increase recycling of plastic bags and wraps. Plastic bags can be returned to approximately 200 local grocery and retail stores in the state. The campaign supports the state goal to divert 60% of trash from the waste stream by 2024 (Connecticut Department of Energy & Environmental Protection, 2017).
	Delaware	Recycling	2009	Since December 1 st , 2009 all retail stores of at least 7000 square feet, or retailers with three or more Delaware locations are required to provide in-store plastic bag recycling as well as reusable bags for purchase. Retailers must also have a message that encourages plastic bags recycling (Delaware General Assembly, 2009).
	District of Columbia	Levy	2009	On September 23 rd , 2009, the Anacostia River Clean Up and Protection Act of 2009 took effect. The act, also known as the “Bag Law” requires that businesses that sell food or alcohol charge a 0.05USD for each plastic and paper bag distributed with any purchase. The act also requires that paper and plastic bag be 100% recyclable (DC Department of Energy & Environment, 2015).

	Florida	Recycling	2010	The Florida Department of Environmental Protection, the Florida Recycling Partnership, the Florida Retail Federation, and the Progressive Bag Affiliates of the American Chemistry Council have partnered with A Bag's Life to encourage Floridians to recycle, reuse and reduce their plastic bags. The campaign includes a mobile application with more than 1600 locations where people can recycle their plastic bags (A Bag's Life, 2010-A).
	Georgia	Recycling	2012	Georgia was the seventh state to join the "A Bag's Life" recycling initiative. Nearly 750 grocery and retail stores provide drop-off sites for plastic bags and wraps statewide (A Bag's Life, 2012).
	Idaho	Ordinance ban	2016	In March 2016, the Governor of Idaho signed a bill which states that "any regulation regarding the use, disposition or sale or any imposition of any prohibition, restriction, fee imposition or taxation of auxiliary containers at the retail, manufacturer or distributor setting shall be imposed only by statute enacted by the legislature" (Legislature of the State of Idaho, 2016). The bill took effect on July 1 st , 2016.
	Illinois	Recycling	2016	In May 2016, the "Recycle Thin Film Plastic" program was established through a House Resolution, as an effort to reclaim used thin-film plastics and to encourage customers to use reusable bags. The resolution also established an educational program to promote the recycling of plastic bags and the use of reusable alternatives (Illinois General Assembly, 2016).
	Indiana	Ordinance ban	2016	House Bill 1053 was signed in March 2016 by then Governor Mike Pence. The bill prohibits local governments from imposing a fee or tax as well as restricting or prohibiting the manufacture, use, sale or distribution of reusable or disposable bags made of plastic, paper, cloth, extruded polystyrene or a similar material (Indiana General Assembly, 2016).
	Iowa	Recycling; Ordinance ban	2012; 2017	In 2012, the Iowa Grocery Industry in collaboration with Keep Iowa Beautiful, the Iowa Department of Natural Resources, Metro Waste Authority, City Carton Recycling and The Des Moines Register, established the Build with Bags Grant Program to tackle the concern of plastic bag consumption. The primary goals of this program are to reduce plastic bag consumption, encourage the use of reusable bags, increase plastic bag recycling, and

			<p>establish a grant program to aid parks and schools in purchasing products made of recycle plastics. Recycling bins are placed at store fronts to encourage customers to recycle. The plastic bags recycled through this program are used to convert plastic bags into recycled products for park or schools (Iowa Grocery industry, 2017).</p> <p>In April 2017, Iowa became the eighth state to enact a prohibition on bag ordinances. The prohibition took effect immediately, killing all local efforts to enact bag bans, fees or taxes (Iowa Legislature, 2017). The law, however, does not apply to the voluntary initiative stated above.</p>
Louisiana	Recycling	2013	Since 2013, Best Buy, Target, Kroger, Lowe’s and Walmart’s in Louisiana have teamed up with “A Bag’s Life” to help promote the reduction, recycling and reuse of plastic bags (A Bag’s Life, 2017).
Maine	Recycling	1991	Stores in Maine who provide plastic bags to their customers are required by law to locate inside their stores or within 20 feet of the main entrance, a receptacle for collecting any used plastic bags (Maine Department of Environmental Protection, 2016).
Massachusetts	Ban & Fee (Pending)	2018	Bill S.424 is currently being studied by the Joint Committee on environmental, Natural Resources and Agriculture to phase-out single use carryout bags by August 2018. As defined in the bill, single-use carryout bags are bags made of either plastic, paper or other materials. If passed, the bill would prohibit stores from providing single-use carryout bags free of charge to their customers until August 1 st , 2018. After this date, single-use carryout bags shall not be provided to customers at the point of sale. However, after August 1 st , 2018, recycled paper bags and reusable grocery bags may be made available, but at a charge of no less than 0.10\$ (The General Court of the Commonwealth of Massachusetts, 2016).
Michigan	Ordinance ban	2017	In December 2016, a bill to prohibit local governments from adopting or enforcing an ordinance in relation to the use, distribution, sale, restriction of “auxiliary containers” was approved by the governor. For the purpose of this law, the term “auxiliary containers” includes, but is not limited to, single-use

				or reusable plastic bags. The bill took effect in March 2017. It also prohibits local governments from imposing a fee, charge, or tax on these containers (State of Michigan, 2016).
Minnesota	Ordinance ban	2017		Minneapolis was set to ban plastic bags in June 2017, however, the state had plans of its own. In fact, days before the ban was to take effect, Governor Mark Dayton signed a budget bill that contained a provision prohibiting local government from banning the use of paper, plastic or reusable bags (Nelson, E., 2017; State of Minnesota, 2017).
Missouri	Ordinance ban	2015		House Bill 722 was introduced on January 28 th , 2015. The bill prohibits local governments from imposing a ban, fee or tax on the use of either paper or plastic bags. Although it was vetoed by the Governor, the veto was passed over and the bill took effect in September 2015 (General Assembly of the State of Missouri, 2015; Missouri House of Representatives, 2015).
New York	Recycling	2009		<p>New York State’s Plastic Bag Reduction, Reuse and Recycling Act has been in effect since January 1st, 2009. This act requires all stores with a retail space of 10,000 square feet or more as well as chains which operate five or more stores with greater than 5,000 square feet of retail space to establish and in-store plastic bag and film plastics recycling program. These stores must therefore make available a collection bin that is visible, easily accessible and clearly marked. Any bags distributed in affected stores must also be labeled in a way that encourages recycling. A statement such as “Please Return to a Participating Store for Recycling” is accepted. Stores are also required to make reusable bags accessible to their customers (New York State Department of Environmental Conservation, 2015).</p> <p>On December 31st, 2011, the state also launched the “A Bag’s Life” campaign to remind New Yorkers of the importance of recycling their plastic bags (A Bag’s Life, 2011-A).</p>
North Carolina	Recycling	2011		In March 2011, North Carolina became the fourth state to join the “A Bag’s Life Campaign. The goal of this campaign is to get people to recycle, reuse and reduce their plastic bags. To reach this goal, over 1200 new plastic bag

				recycling drop off sites at retail stores across the state were established (A Bag's Life, 2011-B).
Ohio	Recycling	2009		In 2009, the Ohio Grocers Foundation in collaboration with the Ohio Department of Natural Resources and major wholesalers implemented a plastic bag recycling initiative by supplying members with plastic recycling bins (Ohio Grocers Association, 2009). People are therefore encouraged to recycle plastic bags at their local grocery store (Ohio State University, 2017).
Pennsylvania	Recycling	2011		In December 2011, Keep Pennsylvania Beautiful launched the "A Bag's Life" campaign to promote the recycling of plastic bags. The campaign identifies over 1400 locations statewide where people can drop off their plastic bags for recycling (A Bag's Life, 2011-C).
Rhode Island	Ban (Pending)	2017		On March 17 th , 2017, Representatives Edwards, Canario, Kazarian, Amore, and Lima introduce House Bill 5946 which seeks to reduce plastic bag consumption in Rhode Island. If passed, the bill would prohibit retail establishments from providing anything other than plastic bags with at least 20% recycled content, 100% recyclable paper bags, compostable bags and reusable bags. As of June 21 st , 2017, the committee recommended the measure be held for further study (State of Rhode Island General Assembly, 2017).
Texas	Recycling	2010		In early 2010, Texas became the third state to join the "A Bag's Life" campaign with the help of Representatives from the Texas General Land Office, the Texas Commission on Environmental Quality, Keep Texas Beautiful, the Texas Department of Transportation, the State of Texas Alliance for Recycling and the Texas Retailers Association. Nearly 1800 drop-off locations across the state where people can bring their plastic bags for recycling have been identified (A Bag's Life, 2011-D).
Vermont	Ban or Fee (Pending)	2017		Two proposals that aim to reduce plastic bags in the Green Mountain State, have been referred to the Committee on Natural Resources, Fish & Wildlife in 2017. One proposal, Bill H.88, would establish a 0.10USD charge for every disposable carryout bag (Vermont General Assembly, 2017-A). The other proposal, Bill H.105, would prohibit the retail establishments from providing a single-use carryout bag to customers and would also establish standards for

				reusable bags and compostable bags (Vermont General Assembly, 2017-B). Both proposals have missed key legislative dates, therefore, the earliest they could pass would be 2018.
Virginia	Recycling	2010		Virginia was the second state to launch the “A Bag’s Life” campaign. The campaign, supported by Governor Bob McDonnell’s administration, the Virginia Retail Federation and Keep Virginia Beautiful, identifies over 800 drop-off locations statewide where people can recycle their plastic bags (A Bag’s Life, 2010-B).
Wisconsin	Ordinance ban	2016		The 2015 Wisconsin Act 302 prohibits local governments from enacting or enforcing an ordinance or resolution regulating the use, disposition, or sale of auxiliary containers. It also prohibits local governments from prohibiting or restricting these containers as well as imposing a fee, charge or surcharge. The Act was enacted on March 30 th , 2016 (Wisconsin State Legislature, 2016).
American Samoa	Ban	2011		On February 2011, a plastic bag ban took effect. The ban prohibits wholesale or retail establishments from directly or indirectly providing, giving or making available plastic shopping bags to their customers. Are allowed, however, shopping bags produced entirely from non-petroleum-based biodegradable plastic, compostable plastic bags as well as plastic bags used for hygiene purposes (Legislature of American Samoa, 2010; American Samoa Environmental Protection Agency, 2017).
Puerto Rico	Ban & Levy	2016		On December 29 th , 2015, Act 247-2015 was signed into law. The Act promotes the use of reusable bags and prohibits retail stores and other commercial establishments from providing plastic bags to their customers. These include not only conventional plastic bags, but also biodegradable and compostable alternatives. Paper bags are allowed; however, the Act imposes a fee on these bags. The use of reusable bags is highly encouraged and must meet certain requirements, such as having the capacity to carry at least 22 pounds a distance of 75 feet for at least 125 times. The Act took effect of December 30 th , 2016 (Departamento de Asuntos del Consumidor, 2016; Bag Laws, 2016).

	U.S. Virgin Islands	Ban	2017	According to Bill No. 31-0379, plastic checkout bags as well as non-recyclable paper bags may not be provided to customers at the point of sale in all businesses operating in the U.S. Virgin Islands. The bill was approved on September 20 th , 2016 and took effect on January 1 st , 2017 (Legislature of the Virgin Islands, 2016).
Oceania				
Australia	Australian Capital Territory	Ban	2011	Plastic bags less than 35 microns thick have been banned in the Australian Capital Territory since November 1 st , 2011. However, thin plastic bags used for hygiene purposes are exempt (Australian Capital Territory Government, 2017)
	Northern Territory	Ban	2011	A ban on plastic bags came into effect on September 1 st , 2011. This ban prohibits retailers from selling or giving away plastic bags less than 35 microns thick with handles. The ban also extends to degradable plastic bags that do not meet the Australian Standard AS 4736-2006. However, plastic bags used for hygiene purposes as well as paper bags, reusable bags and biodegradable bags – meeting the Australian Standard – are exempt from the ban (Northern Territory Environment Protection Authority, 2017).
	Queensland	Ban	2018	In early 2017, a consultation paper seeking feedback from the public on a possible plastic bag ban saw 96% of respondents supporting the introduction of a ban. Therefore, in September 2017, the government of Queensland passed a law banning the supply of plastic bags less than 35 microns thick. The ban also applies to compostable, degradable and biodegradable plastic shopping bag alternatives. The law is set to come into effect on July 1 st , 2018 (Queensland Government, 2017).
	South Australia	Ban	2009	South Australia was the first state to ban plastic shopping bags in 2009. The ban, which came into effect on May 4 th , 2009, prohibits retailers from selling or giving away plastic bags with handles made of polyethylene polymer less than 35 microns thick. Bags used for hygiene purposes are exempt from this ban (Clean Up Australia, 2015; South Australia EPA, 2017).
	Tasmania	Ban	2013	The <i>Plastic Shopping Bags Act 2013</i> , enforced since November 1 st , 2013, prohibits retailers from selling or giving away plastic shopping bags less than

				35 microns thick. However, compostable biodegradable plastic bags that meet the Australia Standard 4736, re-sealable zipper storage bags, heavier plastic bags as well as plastic bags used for hygiene purposes are exempt from the ban (Tasmania EPA, 2013).
	Victoria	Levy; Ban	2008; NA	In 2008, a trial levy was conducted at four supermarkets in three areas of the state. Although there was a 79% reduction of plastic bag use in these supermarkets due to the 0.08USD levy, the state chose not to continue or expand the levy (Clean Up Australia, 2015). However, in October 2017, following mounting pressure from a petition launched by Channel Ten's 'The Project' in collaboration with Clean Up Australia, the government announced that it will be banning single-use plastic bags. There is, however, yet to be a specific date as to when this ban will take effect (Cooper, L., 2017).
	Western Australia	Ban	2018	As of July 1 st , 2018, plastic shopping bags will be banned in the state of Western Australia (Government of Western Australia, 2017).
Micronesia	Pohnpei	Ban	2012	In September 2011 an act to prohibit the use of plastic bags was passed by the Pohnpei legislature. Therefore, as of April 22 nd , 2012, retailers are no longer allowed to provide plastic bags less than 50 microns thick to their customers. Biodegradable bags certified by the government as well as reusable bags and those used for hygiene purposes are exempt from this law (Pohnpei Legislature, 2011).
	Yap	Ban	2014	In July 2014, a ban on the use of plastic bags was enacted on the islands of Yap. Exempt from this ban are bin liners, produce bags, freezer bags and zip-lock bags (Mariana's Variety, 2014).
Solomon Islands	Western Province	Ban	N/A	In June 2017, the Western Province's Provincial Premier announced that due to alarming levels of plastic bag consumption, these items were to be banned in the province. The exact date of implementation is yet to be announced, but a newly-formed committee of stakeholders is working on a time frame for the ban (World Wildlife Fund Global, 2017). The committee is considering regulations to stop plastic bags from entering the province and encouraging

				the population to use shopping bags made from locally sourced materials (Radio New Zealand, 2017).
South America				
Argentina	Buenos Aires	Ban	2009	According to law 13868, the distribution of non-(bio)degradable plastic bags is prohibited in the province of Buenos Aires. This law, which was passed in 2008, gave a 12-month grace period to commercial establishments before being fully implemented in October 2009 (Logistica, 2009; Ministerio de Gobierno Buenos Aires Provincia, 2008).
	Chubut	Ban	2010	In June 2010 was published in the Chubut Official Gazette No. 10993 the Law XI No. 31 which seeks to regulate the consumption of plastic bags in the province. According to this law, plastic bags shall only be made with certified degradable or biodegradable materials. An education program was also put forth to raise awareness on the rational use of (bio)degradable bags as well as other reusable alternatives and their responsible consumption. Large retailers had up to twelve months to adhere to the new regulation whereas smaller retailers had eighteen months (Gobierno del Chubut, 2010).
	Cordoba	Ban	2011	In February 2011, the Law No. 9696 came into effect in the province of Cordoba (LaVoz, 2011). The law prohibits the use of conventional plastic bags. Commercial establishments such as grocers and retailers that offered such plastic bags must now offer plastic bags made with (bio)degradable materials (Legislacion de la Provincia de Cordoba, 2009).
	La Rioja	Ban	2008	Published in the Official Bulletin of July 15 th , 2008, Law No. 8277 prohibits the distribution of non-biodegradable plastic bags in the Province of La Rioja (Provincia de la Rioja, 2008).
	Mendoza	Ban	2005	A law aiming to reduce the consumption of conventional plastic bags was first published and enacted in January 2005. This law prohibited the distribution of non-biodegradable plastic bags (Jaliff, Petri, Vicchi & Manzitti, 2005). It was later modified in 2007 to allow not only biodegradable plastic bags, but also oxibiodegradable, degradable and hydrodegradable plastic bags throughout the province (Jaliff, Rodriguez, marin & Manzitti, 2007).

	Neuquen	Ban	2007	In November 2007, the government of the Province of Neuquen sanctioned a law to prohibit the use of lightweight plastic bags. Under the new law, commercial establishments that provide plastic bags to customers may only provide bags that fit the degradable, oxibiodegradable, biodegradable or hydrodegradable characteristics (Gobierno de la Provincia del Neuquen, 2012)
	Rio Negro	Ban	2009	The law No. 4.417 of 2009 instituted a program aimed at reducing and gradually replacing the use of conventional plastic bags in the province by biodegradable alternatives. To do so, an education and awareness campaign was implemented to incite consumers to turn to more environmentally friendly alternatives (Legislatura de la Provincia de Rio Negro, 2009).
Brazil	Goias	Ban (In progress)	2018	Following the implantation of Law No. 16.268, commercial establishments that provide plastic bags to their customers are obliged to use biodegradable bags. These bags must degrade within 18 months and must present as the only results of biodegradation CO ₂ , water or biomass. The ban was first supposed to come into effect in 2009 but was later postponed to 2013 and then 2018 (Governo do Estado de Goias, 2013).
	Rio de Janeiro	Reduction strategy	2010	In July 2010, law 5.502/09 came into effect. This law does not ban or put a levy on plastic bags, but instead encourages customers to recycle plastic bags and use reusable alternatives. In fact, the law states that grocers should provide alternatives to plastic bags and that for every five items purchased, the customer that does not use a plastic bag will earn a 0.01USD reduction. A kilo of rice or beans shall also be given for every 50 plastic bags brought back to stores for recycling (Governo do Rio de Janeiro 2012).
Ecuador	Galapagos Islands	Ban	2015	In 2014, the Galapagos Governing Council issued a resolution to rid the archipelago of plastic bags. The first step taken in this direction was to deliver cloth bags to every family in the archipelago in an effort to educate and raise awareness about the environmental and social impacts of plastic bags. As of August 2015, plastic bags have been banned in the Galapagos (Galapagos Conservancy, 2014).

Appendix C: Worldwide Local Initiative

Country	City	Type	Year	Details
Africa				
Chad	N'djamena	Ban	2010	In 1992, a law prohibiting the importation of plastic bags in the Chad capital was approved. However, it was never strictly enforced until 2010, when Marie Thérèse Mbailemdana became mayor of N'Djamena. As soon as she entered office, she began working on banning plastic bags in the capital city by working with business owners to find alternatives and enforcing fines one people found with plastic bags. Consumers must now bring their own bags when shopping (IRIN News, 2010).
Comoros	Moroni	Ban	2016	Plastic bags have been banned in the capital of Comoros since the beginning of 2016. Paper bags are instead offered to customers and the municipal police has been ordered to strictly enforce the ban (Comores Info, 2016).
Mauritius	Rodrigues	Ban	2014	Before the country banned plastic bags, the autonomous island of Rodrigues approved the “Rodrigues regional assembly (prohibition of use of plastic bags) regulations 2014”. These regulations prohibit the possession, use, distribution, sale, manufacture and import or plastic shopping bags (Rodrigues regional assembly, 2014).
Namibia	Swakopmund	Levy (proposed)	2018	Swakopmund has been considering the implementation of levy on plastic bags in supermarkets and retail establishments to reduce the estimated 25 million plastic shopping bags used annually in the city. The levy, which would go towards an environmental fund is expected to come into operation in early 2018 (Namib Times, 2017).
Asia				
India	Delhi	Ban	2017	The National Green Tribunal (NGT) introduced a ban on disposable plastics in the capital city in January 2017. The ban includes cutlery, cups, bags and other forms of single-use plastics (Johnston, I., 2017). However, due to lack of enforcement, the NGT imposed an interim ban on the use of non-biodegradable plastic bags less than 50 microns in August 2017 and directed

				the Delhi government to seize the entire stock of plastic with one week (Live Mint, 2017).
	Karwar	Ban	2010	On August 15 th , 2010, a ban on the storage and distribution of plastic bags within city limits took effect. Commercial establishments, hotels, choultries, cinemas and shops must comply with this law (The Hindu, 2010).
	Mumbai	Ban	2005	Plastic bags less than 50 microns thick have been banned in the city of Mumbai ever since they were named the main culprits of the disastrous floods of July 2005 (Fleury, J., 2012).
	Thiruvananthapuram	Ban	2017	A blanket ban on all types of plastic carry-out bags has been imposed since March 1 st , 2017 (The Indian Express, 2017).
Indonesia	Jakarta	Ban	2016	In Early 2016, Jakarta withdrew from a national policy requiring stores to charge for plastic bags. Instead, the Jakarta administration has decided to order retailers to use biodegradable plastic bags. Retailers can then voluntarily decide to charge customers for the plastic bags (Wardhani, D.A., 2016).
Japan	Hamamatsu	Voluntary	2008	Following an agreement on efforts to reduce plastic bags, consumers have been encouraged to bring their own bags when shopping. Stores participating in this agreement also charge for every plastic bag used by their customers (Japan Ministry of Environment, 2012).
	Kawasaki	Voluntary	N/A	The city has concluded agreements with businesses and consumer groups where participating stores charge consumers for their plastic bags (Japan Ministry of Environment, 2012).
	Sapporo	Voluntary	2007	Since 2007, the city of Sapporo has been continuously signing agreements with businesses and consumer groups to tackle plastic bag pollution. Participating establishments charge a fee for every plastic bags used by their customers (Japan Ministry of Environment, 2012).
	Sendai	Voluntary	2007	An agreement to reduce plastic shopping bags in the city of Sendai was reached between the Sendai city, businesses and consumer groups. Companies participating in this agreement charge consumers for every

				plastic bags used and encourage customers to bring their own bags (Tsunoda, I., 2007).
	Shizuoka	Voluntary	2008	In an effort to reduce plastic bags in the city, an agreement was reached with businesses and consumer groups where participating stores charge for plastic bags (Japan Ministry of Environment, 2012).
	Toyota City	Voluntary	2007	Agreements have been signed between the city and businesses since 2007. Participating stores charge for plastic bags and encourage consumers to bring their own bags (Japan Ministry of Environment, 2012).
South Korea	Seoul	Ban, Fee & Voluntary	2017	On September 13 th , 2017, it was announced that the Seoul Metropolitan Government (SMG) would be implementing measures to reduce plastic bag consumption in the city. A total of 16 programs are expected to be implemented by 2020. For instance, businesses are encouraged to use paper bags instead of plastic bags and their customers are highly encouraged to bring their own bags. Another program will be taking place in flea markets, which are held from April to October each year. In 2017, these markets could only use plastic bags for wet or frozen food, however, next year (2018), plastic bags will be banned altogether. Controls will also be tightened on businesses with more than 33 square meters of retail space to make sure that they respect the regulation to not provide plastic bags free of charge. Another program will improve separate garbage collection for proper disposal and recycling of plastic bags (Seoul Metropolitan Government, 2017).
Malaysia	Kuching North	Ban	2018	A campaign was launched in early 2017 to reduce the use of non-biodegradable plastic bags. The campaign encourages shop owners and their customers to use either biodegradable plastic bags or another reusable alternative. The Kuching North City Commission plans to ban non-biodegradable plastic bags altogether in 2018, however, they are providing alternatives beforehand to ensure that once the ban will take effect, the public will be ready (Sibon, P., 2017).
	Sibu	Ban	2017	The “Say No to Plastic Bags 2.0” campaign was launched on October 1 st , 2017. This campaign designates three days (Saturday, Sunday and Monday)

				as no plastic bag days. Consumers are therefore required to bring their own bags when shopping on these three days. Businesses are also encouraged to replace conventional plastic shopping bags with biodegradable and/or reusable alternatives. The campaign is expected to be fully implemented in January 2018 to completely ban conventional plastic bags (Sibu Municipal Council, 2017).
Maldives	Bodufolhudhoo	Ban & Levy	2016	Plastic bags have been banned in grocery stores on the island of Bodufolhudhoo since January 1 st , 2016 as part of Maldives Getaways’ “Ban the Bags” campaign. To encourage the use of reusable bags, every local household was provided with cloth bags. Shoppers who do not bring their own bags will be charged for every bag they use while shopping (Maldives Getaways, 2015).
	Keyodhoo	Ban	2017	Plastic bags have been banned on the island of Keyodhoo since January 2017 in an effort to become a more environmentally friendly island. To support this initiative, Dhiraagu, a provider of telecommunications and digital services in the Maldives, donated over 1500 reusable bags which will help provide environmentally friendly bags for every household (Maldives Getaways, 2016-A).
	Maalhos	Ban & Levy	2017	Maalhos island has joined Maldives Getaways’ initiative to make Maldives a plastic free archipelago by 2020. The island has therefore launched a project to gradually reduce plastic bags by charging consumers for their use. Dhiraagu has donated 1000 reusable bags which will be provided to consumers. The island hopes that by charging for plastic bags, consumers will bring their own and plastic bags will be phased-out (Rahman, T.A., 2017).
	Ukulhas	Ban	2017	Ukulhas was the third island to join Maldives Getaways’ “Ban the Bags” campaign. Single-use plastic bags were outlawed as of January 1 st , 2017 throughout the island. Environmentally friendly bags, donated by Dhiraagu, were provided to every household to encourage consumers to bring their own bags (Maldives Getaways, 2016-B).

Myanmar	Mandalay	Ban	2009	High-density polyethylene (HDPE) bags have been banned in Mandalay since June 2009 (Mizzima News, 2009).
	Nay Pyi Taw	Ban	2009	HDPE bags were banned in June 2009 (Mizzima News, 2009).
	Yangon	Ban	2011	HDPE bags were banned in April 2011. Businesses are therefore prohibited to manufacture, import, sell or distribute these bags. However, low-density polyethylene and polypropylene bags are still allowed (Phyu, A.S. & Gaung, J.S., 2011).
Nepal	Kathmandu	Ban (failed)	2015	Plastic bags below 40 microns were intended to be banned by the Nepali New Year (April 14 th , 2015), but poor implementation meant that plastic bag use was left unchecked. In 2016, a new directive announced a nationwide ban on the import, export, distribution, use and sale of plastic bags below 30 microns thick starting July 17 th , 2017 (The Kathmandu Post, 2017). <i>See national appendix for more information on the nationwide ban</i>
Singapore	National University of Singapore	Voluntary	2010	The National University of Singapore's green group, Students Against the Violation of the Earth (SAVE) implemented a 10-cent tax for plastic bags sold in canteens and co-ops across the campus. The proceeds collected go towards the University's Sustainability Fund (Teasdale, M., 2013).
Thailand	Bangkok	Voluntary	2009-2010	In 2009 and 2010, the Bangkok Metropolitan Administration held a 45-day campaign where consumers who brought their own bags were offered a 1-baht discount for every 100-baht purchase. Consumers who did not have their own bags were charged 1-baht per plastic bag (Corporal, L.L., 2010).
Turkey	Bozcaada	Ban	2011	The Bozcaada municipality board decided in April 2011 to prohibit the use of plastic bags as of June 5 th , 2011 (Hattam, J., 2011).
	Kadikoy	Ban	2010	In 2010, Kadikoy became the first district in Turkey to ban plastic bags (Hurriyet Dailey News, 2016).
	Princes' Islands	Ban	2016	In 2011, the Istanbul municipality of Princes' Islands promoted the reduction of plastic bags by encouraging the use of paper and reusable alternatives. As of May 1 st , 2016, the municipality decided to ban plastic bags altogether (Hurriyet Dailey News, 2016).

United Arab Emirates	Dubai	Voluntary	2013	In May 2013, the Dubai municipality launched a six-month public awareness campaign to reduce plastic bag use. Jute bags were distributed to consumers in addition to campaign flyers to educate the public about the effects of plastic bags use. The campaign was carried out every Thursday, Friday and Saturday in 190 supermarkets (Al Serkal, M., 2013).
Europe				
Albania	Tirana	Voluntary	2017	A three-week campaign was launched in collaboration with the supermarket chain CONAD to raise awareness on the need to reduce plastic bags. During these weeks, customers were asked for a voluntary monetary contribution for each plastic bag. Although the campaign came to an end, other supermarkets joined forces with CONAD and introduced a small fee for each plastic bag (United Nations, 2017).
Greece	Alonnisos	Ban & Levy	2015	The “Plastic Bag Free Alonnisos” project funded by the Thalassa Foundation, in collaboration with the municipality as well as the Mediterranean SOS Network and the Hellenic Society for the study and Protection of the Monk Seal was launched on December 1 st , 2015. Businesses have therefore stopped distributing plastic bags to their customers and instead provide paper or cotton bags for a fee. To encourage the use of reusable bags, the Thalassa Foundation distributed 2000 cotton bags to local households (Thalassa Foundation, 2015).
United Kingdom	Modbury (England)	Ban	2007	In May 2007, all 43 shops in the small town of Modbury decided to stop providing plastic bags to their customers. Instead, they now provide reusable or biodegradable alternatives and encourage their customers to bring their own bags (Vidal, J., 2007).
North America				
Belize	Belmopan	Voluntary	2014	In November 2014, the U.S. Embassy in Belize partnered with businesses to reduce excessive use of plastic bags. To do so, they provided reusable bags to participating businesses and when a customer requested one, they received a discount on their purchase (Nunez, D., 2015).

	San Pedro, Ambergris Caye	Voluntary	2015	In January 2015, the San Pedro chapter of the Vision Inspired by the People contacted the U.S. Embassy in Belize to introduce their reusable bag initiative in the city. The Embassy accepted the invitation and on April 22 nd , 2015, the program was launched in three participating businesses. These businesses now offer discounts to customers who request or bring reusable shopping bags (Nunez, D., 2015).
Canada	Brossard (Quebec)	Ban	2016	In February 2016, the city of Brossard passed a by-law relating to the distribution of shopping bags. The by-law prohibits the use, sale, distribution and offer of any plastic shopping bags less than 100 microns thick. Businesses may still provide reusable shopping bags or paper bags as well as very-lightweight plastic bags used for hygiene purposes. The by-law came into effect on September 1 st , 2016. Information and awareness activities were conducted during the transition period to give businesses and residents time to progressively adapt to the new measure (City of Brossard, 2016).
	Calixa-Lavallée (Quebec)	Ban	2018	Conventional plastic bags less than 50 microns thick as well as oxo-degradable, oxo-fragmentable and biodegradable bags regardless of their thickness will be banned as of January 1 st , 2018 (Ville de Varennes, 2017; MRC de Marguerite-d'Youville, 2017).
	Contrecoeur (Quebec)	Ban	2018	Conventional plastic bags less than 50 microns thick as well as oxo-degradable, oxo-fragmentable and biodegradable bags regardless of their thickness will be banned as of January 1 st , 2018 (Ville de Varennes, 2017; MRC de Marguerite-d'Youville, 2017).
	Deux-Montagnes (Quebec)	Ban	2009	On July 1 st , 2009, a by-law came into effect which prohibits the distribution and sale of single-use plastic bags in commercial outlets (Ville de Deux-Montagnes, 2013). In 2014, a modification was made to allow for distribution and sale of single-use biodegradable plastic bags (Ville de Deux-Montagnes, 2014).
	Fogo Island (Newfoundland and Labrador)	Ban	2015	In August 2015, grocery stores in the Town of Fogo Island stopped providing plastic bags to their customers. They instead offered paper bags and encouraged customers to bring their own bags (Town of Fogo Island, 2015).

Huntingdon (Quebec)	Ban	2008	In January 2008, a ban on non-biodegradable plastic bags came into effect in the town of Huntingdon. Are accepted, paper and biodegradable alternatives (Retail Council of Canada, 2017).
Leaf Rapids (Manitoba)	Ban	2007	The northern Manitoba town of Leaf Rapids was the first community in Canada to ban single-use plastic bags. The bylaw prohibits the sale and distribution of single-use plastic bag while encouraging the use of reusable shopping bags (CBC News, 2007).
Mont-Saint-Hilaire (Quebec)	Ban	2018	Plastic shopping bags less than 50microns thick will be banned on Earth Day 2018 (April 22 nd , 2018). Oxo-degradable, oxo-fragmentable, biodegradable and compostable bags will also be prohibited. However, lightweight plastic bags used for hygiene purposes will still be allowed (Retail Council of Canada, 2017).
Montreal (Quebec)	Ban	2018	A ban on plastic bags less than 50 microns thick as well as oxo-degradable, oxo-fragmentable or biodegradable shopping bags will come into effect on January 1 st , 2018. Thin plastic bags used for hygiene purposes will continue to be accepted. The by-law was posted at city hall and published in <i>The Gazette</i> on August 30 th , 2016, which leaves plenty of time for information and awareness activities to ensure compliance once the ban takes effect (City of Montreal, 2016).
Saint-Amable (Quebec)	Ban	2018	Conventional plastic bags less than 50 microns thick as well as oxo-degradable, oxo-fragmentable and biodegradable bags regardless of their thickness will be banned as of January 1 st , 2018 (Ville de Varennes, 2017; MRC de Marguerite-d'Youville, 2017).
Saint-Ansèlme (Quebec)	Ban	2009	A ban on any non-biodegradable plastic bags came into effect on January 1 st , 2009. Paper bags as well as biodegradable alternatives are still accepted (Retail Council of Canada, 2017).
Saint-Basile-le-Grand (Quebec)	Ban	2018	By-law number 1114 prohibits the distribution of plastic bags less than 50 microns thick as well as oxo-degradable, oxo-fragmentable, biodegradable and compostable plastic bags regardless of thickness. The by-law will take effect on April 22 nd , 2018. An information and awareness campaign has been

				underway since April 22 nd , 2017 to ensure public education before the by-law comes into effect (Ville de Saint-Basile-le-Grand, 2017).
Saint-Bruno-de-Montarville (Quebec)	Ban	2018		In June 2017, a by-law was adopted which prohibits plastic bags less than 100 microns thick as well as compostable plastic bags. The by-law will take effect on April 22 nd , 2018 and a transition period will ensure public awareness and education relating to the new measure (Ville de Saint-Bruno-de-Montarville, 2017).
Saint-Jean-Baptiste (Quebec)	Ban	2018		Plastic bags with a thickness inferior to 50 microns will be banned on April 22 nd , 2018. Oxo-degradable, oxo-fragmentable, biodegradable and compostable plastic bags regardless of their thickness will also prohibited. Thin plastic bags used for hygiene purposes are exempt from this by-law (Retail Council of Canada, 2017).
Sainte-Julie (Quebec)	Ban	2018		Conventional plastic bags less than 50 microns thick as well as oxo-degradable, oxo-fragmentable and biodegradable bags regardless of their thickness will be banned as of January 1 st , 2018 (Ville de Varennes, 2017; MRC de Marguerite-d'Youville, 2017).
Sainte-Martine (Quebec)	Ban	2010		A ban on all plastic bags which are not completely biodegradable was unanimously passed in July 2009. It took effect on January 1 st , 2010 (Ville de Ste-Martine, 2011).
Thompson (Manitoba)	Ban	2010		The "Single-Use Plastic Bags By-Law" which came into effect on December 31 st , 2010 prohibits the sale and free distribution of plastic bags less than 50 microns thick (City of Thompson, 2010).
Toronto (Ontario)	Ban & Levy (Failed)	2009		The war against plastic bags has been an issue in Toronto for many years. In 2009, city council required stores to charge for these items, however, in 2012, Mayor Rob Ford pledged to do away with the fee. When asked to scrap the fee, the council voted to instead ban the bags altogether. However, a lawsuit from the plastics industry and opposition from the retail sector resulted in the ban being overturned in late 2012 (Karstens-Smith, G., 2014).
Varennes (Quebec)	Ban	2018		Conventional plastic bags less than 50 microns thick as well as oxo-degradable, oxo-fragmentable and biodegradable bags regardless of their

				thickness will be banned as of January 1 st , 2018 (Ville de Varennes, 2017; MRC de Marguerite-d'Youville, 2017).
	Verchères (Quebec)	Ban	2018	Conventional plastic bags less than 50 microns thick as well as oxo-degradable, oxo-fragmentable and biodegradable bags regardless of their thickness will be banned as of January 1 st , 2018 (Ville de Varennes, 2017; MRC de Marguerite-d'Youville, 2017).
	Victoria (British Columbia)	Ban & Levy (Proposed)	2018	On October 26 th , 2017, the City Council approved a motion to consider a single-use checkout bag bylaw. The bylaw would prohibit businesses from selling and distributing plastic bags to their customers and would instead offer paper or reusable bags. Paper bags would cost a minimum of 12 cents and reusable bags would be no less than 2 dollars. The bylaw is currently under review and the council is seeking public feedback (City of Victoria, 2017).
	Whistler (British Columbia)	Voluntary	2015	In May 2015, the Alliance of Grocery and Drug Stores in Whistler instituted a five-cent fee for every plastic bag used by customers. Grocery and drug stores encouraged consumers to bring their own bags (Dupuis, B., 2016).
	Wood Buffalo (Alberta)	Ban	2010	The "Single-Use Shopping Bag" bylaw was enacted in September 2010 and modified in 2012. The bylaw prohibits retail establishments from providing, distributing, selling and using single-use plastic bags less than 57 microns thick. The bylaw does not apply to plastic bags used for hygiene purposes as well as those used in the restaurant and food service sectors (Regional Municipality of Wood Buffalo, 2012).
Costa Rica	Alajuela	Ban	2017	The substitution of plastic bags for reusable alternatives is underway in the municipality of Alajuela after it joined the national initiative to reduce single-use plastic consumption (Zona Libre de Plastico, 2017).
	Alvarado	Ban	2017	In June 2017, through ordinance number 15-2017, the municipalities of the province of Cartago joined the national initiative to reduce plastic bag consumption. By declaring themselves a plastic bag free zone, the municipalities are transitioning from plastic bags to reusable and compostable alternatives. This became a statewide initiative through municipal action (Zona Libre de Plastico, 2017).

Aserri	Ban	2017	Aserri joined the national initiative to reduce the consumption of single-use plastics, including plastic bags, in September 2017 (Zona Libre de Plastico, 2017)
Cartago	Ban	2017	In June 2017, through ordinance number 15-2017, the municipalities of the province of Cartago joined the national initiative to reduce plastic bag consumption. By declaring themselves a plastic bag free zone, the municipalities are transitioning from plastic bags to reusable and compostable alternatives. This became a statewide initiative through municipal action (Zona Libre de Plastico, 2017).
Cervantes	Ban	2017	In June 2017, through ordinance number 15-2017, the municipalities of the province of Cartago joined the national initiative to reduce plastic bag consumption. By declaring themselves a plastic bag free zone, the municipalities are transitioning from plastic bags to reusable and compostable alternatives. This became a statewide initiative through municipal action (Zona Libre de Plastico, 2017).
Cobano	Ban	2017	Cobano is another municipality that joined the national initiative to reduce plastic bag consumption. By declaring themselves a plastic free zone, the municipality is transitioning from plastic bags to reusable and compostable alternatives (Zona Libre de Plastico, 2017).
Desemparados	Ban	2017	Desemparados joined the national initiative to reduce single-use plastic consumption, including plastic bags, in October 2017. By declaring themselves a plastic free zone, the municipality is transitioning from plastic bags to reusable and compostable alternatives (Zona Libre de Plastico, 2017).
Guarco	Ban	2017	In June 2017, through ordinance number 15-2017, the municipalities of the province of Cartago joined the national initiative to reduce plastic bag consumption. By declaring themselves a plastic bag free zone, the municipalities are transitioning from plastic bags to reusable and compostable alternatives. This became a statewide initiative through municipal action (Zona Libre de Plastico, 2017).

	Jiménez	Ban	2017	In June 2017, through ordinance number 15-2017, the municipalities of the province of Cartago joined the national initiative to reduce plastic bag consumption. By declaring themselves a plastic bag free zone, the municipalities are transitioning from plastic bags to reusable and compostable alternatives. This became a statewide initiative through municipal action (Zona Libre de Plastico, 2017).
	La Union	Ban	2017	In June 2017, La Union joined the national initiative for the substitution of single-use plastic bags. Through the “Plastic Free Zone” initiative the municipality prohibits the use and distribution of single-use plastic bags in the municipality and promotes the use of renewable and reusable alternatives (Zona Libre de Plastico, 2017).
	Moravia	Ban	2017	In October 2017, plastic bags started to be substituted for reusable and compostable alternatives after the municipality joined the “Plastic Free Zone” program (Zona Libre de Plastico, 2017).
	Oreamuno	Ban	2017	In June 2017, through ordinance number 15-2017, the municipalities of the province of Cartago joined the national initiative to reduce plastic bag consumption. By declaring themselves a plastic bag free zone, the municipalities are transitioning from plastic bags to reusable and compostable alternatives. This became a statewide initiative through municipal action (Zona Libre de Plastico, 2017).
	Paraiso	Ban	2017	In June 2017, through ordinance number 15-2017, the municipalities of the province of Cartago joined the national initiative to reduce plastic bag consumption. By declaring themselves a plastic bag free zone, the municipalities are transitioning from plastic bags to reusable and compostable alternatives. This became a statewide initiative through municipal action (Zona Libre de Plastico, 2017).
	Tibas	Ban	2017	Tibas is the latest municipality in Costa Rica to order the substitution of plastic bags for reusable alternatives, by publishing a bylaw of this nature in November 2017 (Zona Libre de Plastico, 2017).
	Tucurrique	Ban	2017	In June 2017, through ordinance number 15-2017, the municipalities of the province of Cartago joined the national initiative to reduce plastic bag

				consumption. By declaring themselves a plastic bag free zone, the municipalities are transitioning from plastic bags to reusable and compostable alternatives. This became a statewide initiative through municipal action (Zona Libre de Plastico, 2017).
	Turrialba	Ban	2017	In June 2017, through ordinance number 15-2017, the municipalities of the province of Cartago joined the national initiative to reduce plastic bag consumption. By declaring themselves a plastic bag free zone, the municipalities are transitioning from plastic bags to reusable and compostable alternatives. This became a statewide initiative through municipal action (Zona Libre de Plastico, 2017).
Guatemala	Cantel	Ban	2015	Cantel was the second city in Guatemala to ban the use of plastic bags on its territory (Saloj-Chiyal, B.L., 2017)
	San Juan Sacatepequez	Ban	2015	San Juan Sacatepequez became the first city in Guatemala to ban the use of plastic bags in 2015 (Saloj-Chiyal, B.L., 2017).
	San Pedro la Laguna	Ban	2017	Law 111-2016, which prohibits plastic bags, straws as well as Styrofoam containers and all packaging materials made of polystyrene became effective in January 2017 (Saloj-Chiyal, B.L., 2017).
Honduras	Guanaja	Ban	2016	In august 2016 came into effect a ban on the use of plastic bags in all supermarkets, warehouses, smaller grocery stores and any other businesses operating and/or located within the municipal order. Commercial establishments may now offer paper bags to their customers as a substitute and the mayor has also distributed two reusable shopping bags to each head of household (Perdomo, R., 2016).
Mexico	Mexico City	Ban	2009	Reforms were made to the Solid Waste Law of the Federal District in 2009 and 2010 which resulted in the ban of non-biodegradable plastic bags in commercial establishments. However, enforcement of this measure has been difficult and conventional plastic bags continue to be used and distributed in the district (Hernandez-Sanchez, J., 2017).
Nicaragua	Little Corn Island	Ban	2015	In an effort to reduce marine pollution, the small Caribbean island of Little Corn Island banned the use of plastic bags throughout its territory in

				February 2015. The government made available reusable and recyclable bags, such as alternatives made of cloth or paper, to encourage a more sustainable use of shopping bags (United Nations Development Program - Nicaragua, 2015).
United States	Bethel, AK	Ban	2010	Since September 2010, plastic carry-out bags have been banned in the city of Bethel, Alaska. Affected establishments, food vendors and non-profit vendors are however allowed to provide alternatives such as reusable bags, recyclable paper bags as well as compostable bags and biodegradable plastic bag. Providing incentives for the use of reusable bags through education and/or store credits and rebates for customers is highly encouraged (Bethel Municipal Code, 2017).
	Cordova, AK	Ban	2016	In late 2015, the Cordova City Council approved an ordinance to prohibit the provision of plastic carry-out bags by retail establishments, food vendors and non-profit vendors. Reusable bags, recyclable paper bags as well as compostable and biodegradable plastic bags are approved alternatives. The ban came into effect in October 2016, a year following its approval, to allow retailers to adapt to the change (Cordova Municipal Code, 2017).
	Fairbanks, AK	Levy (Failed)	2009	Fairbanks adopted an ordinance to charge 0.05USD per plastic bag in September 2009, however, it was rescinded just a month later due to community opposition (Bag Laws, 2017).
	Homer, AK	Ban (Failed)	2013	In late 2012, a partial ban was approved by the Homer City Council to prohibit LPSBs. The ban came into effect on January 1 st , 2013. However, following opposition by citizens, the ban was overturned by popular vote on October 1 st , 2013 (Fight the Plastic Bag Ban, 2013).
	Hooper Bay, AK	Ban	2010	Plastic bags have been banned in Hooper Bay since September 2010 (Bag Laws, 2017).
	Bisbee, AZ	Ban & Levy; Voluntary	2014; 2017	A ban on plastic bags less than 57 microns thick came into effect in September 2014. The ordinance also established a 0.05USD fee on paper bags. However, in 2016, a State law was passed to prohibit such ordinances and the city ordinance was deemed unlawful by the Attorney General. Therefore, the city of Bisbee passed a new ordinance in November 2017

				which eliminated the mandatory nature of the plastic bag ban and instead made it voluntary. Therefore, it is up to individual retail establishments to decide whether they wish to provide single-use plastic shopping bags to their customers and if so, if they will implement a fee (Bisbee City Council, 2017).
	Alameda County, CA	Ban & Levy	2013	Since January 2013, certain retail stores, including grocery stores, convenience stores and pharmacies are prohibited from providing single-use plastic carryout bags, less than 57 microns thick, to their customers. In May 2017, the ordinance was expanded to include all retail stores in the county and as of November 2017, restaurants and eating establishments. The ordinances also require stores that provide paper and reusable bags to charge 0.10USD minimum for these items (Bag Laws, 2017).
	Arcata, CA	Ban & Levy	2014	Plastic bags less than 57 microns have been banned in Arcata since February 1 st , 2014. Stores may provide reusable bags, including reusable plastic bags, recyclable paper bags as well as protective paper bags, but must charge a minimum of 0.10USD for these items (Bag Laws, 2017).
	Belmont, CA	Ban & Levy	2012	In November 2012, the Belmont City Council adopted a resolution to join the San Mateo County in banning plastic and other single use bags at the point of sale. The ordinance prohibits retail establishments from providing plastic bags less than 57 microns thick. Alternatives such as reusable bags and recyclable paper bags are allowed, however a fee must be applied for these items. The fee consisted of 0.10US in 2012 but was increased to 0.25USD in 2015 (Bag Laws, 2017).
	Belvedere, CA	Ban & Levy	2015	Stores are prohibited from providing plastic bags less than 57 microns thick to their customers. Reusable bags, including those made of plastic thicker than 57 microns, and/or recyclable paper bags shall be provided or made available for no less than 0.10USD (Bag Laws, 2017).
	Brisbane, CA	Ban & Levy	2013	In March 2013, the City Council of the City of Brisbane adopted ordinance No. 580 in accordance with the San Mateo County single-use plastic bag ban. The ordinance prohibits stores from providing plastic bags less than 57 microns thick, while requiring stores that provide reusable and/or recyclable

				paper bags at an initial charge of 0.10USD. The minimum charge was increased to 0.25USD in 2015 (Bag Laws, 2017).
Burlingame, CA	Ban & Levy	2013		The City Council of Burlingame adopted the San Mateo County single-use plastic bag ban through Ordinance No. 1883 in April 2013. The ordinance prohibits stores from providing plastic bags less than 57 microns thick, while requiring stores that provide reusable and/or recyclable paper bags at an initial charge of 0.10USD. The minimum charge was increased to 0.25USD in 2015 (Bag Laws, 2017).
Calabasas, CA	Ban & Levy	2012		As of January 2012, all stores in Calabasas are prohibited from providing single-use plastic bags, under 57 microns thick, to their customers. Recyclable paper bags as well as reusable bags, including reusable plastic bags more than 57 microns thick are permitted. Stores that provided recyclable paper bags must charge at least 0.10USD for these bags (Bag Laws, 2017).
Calistoga, CA	Ban & Levy	2015		Single-use plastic bags, with a thickness inferior to 57 microns have been banned in Calistoga since January 2015. Stores may still provide reusable (plastic) bags as well as recyclable paper bags but must charge at least 0.10USD for the paper bags (Bag Laws, 2017).
Campbell, CA	Ban & Levy	2014		As of January 2014, plastic bags less than 57 microns thick have been banned throughout Campbell's retail establishments. Reusable bags, including those made of plastic, as well as recyclable paper bags may still be provided but at a fee of at least 0.25USD (Bag Laws, 2017).
Capitola, CA	Ban & Levy	2013		Ordinance 977 prohibits retail establishments from providing single-use plastic bags to their customers. Recyclable paper bags may still be provided but at a fee of 0.25USD. Reusable bags, including plastic bags with a wall thickness of at least 57 microns are also permitted. It is up to retailers to decide if a charge will be applied for these items (Bag Laws, 2017).
Carmel, CA	Ban	2013		Plastic bags less than 57 microns thick have been banned in Carmel since January 2013 (Bag Laws, 2017).

	Carpentaria, CA	Ban	2012	Plastic bags with a wall thickness inferior to 57 microns have been banned in large grocery stores since July 2012 according to the city Ordinance 655. The ordinance was applied to all other retail establishments in April 2013. Through this ordinance, paper bags must also be recyclable (Bag Laws, 2017).
	Chico, CA	Ban & Levy	2015	Retail establishments may not provide plastic bags less than 57 microns thick to their customers since January 2015. They shall instead provide recyclable paper bags at a minimum charge of 0.10USD as well as provide reusable bags for purchase (Bag Laws 2017),
	City of Beverly Hills, CA	Ban & Levy	2014	Following the implementation of Ordinance No. 14-O-2658 in July 2014, retail establishments in the City of Beverly Hills cannot provide plastic bags less than 50 microns thick to their customers. Recyclable paper bags must be provided for no less than 0.10USD and reusable bags must also be made available either for sale or at no charge (Bag Laws, 2017).
	City of Marina, CA	Ban & Levy	2015	The City of Marina Municipal Code Chapter 8.60 states that retail establishments within the city may not provide plastic bags less than 100 microns to their customers at the point of sale. Recyclable paper bags as well as reusable bags may only be provided if a minimum charge of 0.10USD per bag is applied (Bag Laws, 2017).
	City of Napa, CA	Ban & Levy	2015	The “Single-Use Carryout Bag Reduction” ordinance was enacted in January 2015. The ordinance prohibits retail establishments within the city from providing plastic bags less than 57 microns thick to their customers. Recyclable paper bags shall be provided at a fee of no less than 0.10USD (Bag Laws, 2017).
	Colma, CA	Ban & Levy	2013	In January 2013, the Colma City Council adopted a resolution to join the San Mateo County in banning plastic and other single use bags at the point of sale. The ordinance prohibits retail establishments from providing plastic bags less than 57 microns thick. Alternatives such as reusable bags and recyclable paper bags are allowed, however a fee must be applied for these items. The fee consisted of 0.10US but was increased to 0.25USD in 2015 (Bag Laws, 2017).

Culver City, CA	Ban & Levy	2013	In June 2013, a ban on single-use plastic bags (less than 57 microns) have been banned in retail establishments throughout the city. Stores are required to provide recyclable paper bags for at least 0.10USD. Reusable bags must also be made available for customers to purchase (or for free) as another alternative (Bag Laws, 2017)
Cupertino, CA	Ban & Levy	2013	Plastic bag bans less than 57 microns have been banned in Cupertino since October 2013. Recyclable paper bags may only be available if a minimum charge of 0.10USD is applied (Bag Laws, 2017).
Daly City, CA	Ban & Levy	2013	Since April 22 nd , 2013, single-use plastic bags less than 57 microns have been banned in retail establishments with Daly City. Recyclable paper bags may only be provided if a 0.10USD minimum charge is applied and reusable bags must also be made available (Bag Laws, 2017).
Dana Point City, CA	Ban & Levy	2013	Single-use plastic bag less than 57 microns thick have been banned since April 1 st , 2013. Retail establishments may however, provide recyclable paper bags for at least 0.10USD and make available reusable bags (Bag Laws, 2017).
Davis City, CA	Ban & Levy	2014	As of July 2014, plastic bags less than 57 microns thick have been banned in retail establishments. Recyclable paper bags as well as reusable bags must be made available for no less than 0.10USD (Bag Laws, 2017).
Desert Hot Springs, CA	Ban & Levy	2014	Ordinance No. 543 adopted in March 2014 states that no store shall provide single-use plastic bags less (less than 57 microns) to customers. Stores may also provide recyclable paper bags, but at a minimum charge or 0.10USD (City Council of Desert Hot Springs, 2014).
East Palo Alto, CA	Ban & Levy	2013	In April 2013, the East Palo Alto City Council adopted a resolution to join the San Mateo County in banning plastic and other single use bags at the point of sale. The ordinance prohibits retail establishments from providing plastic bags less than 57 microns thick. Alternatives such as reusable bags and recyclable paper bags are allowed, however a fee must be applied for these items. The fee consisted of 0.10US but was increased to 0.25USD in 2015. The ordinance took effect on October 2 nd , 2013 (Bag Laws, 2017).

	El Cerrito, CA	Ban & Levy	2014	Plastic bags less than 57 microns have been banned since January 2014. Recycled paper bags and reusable bags may be provided as alternatives. However, a minimum charge of 0.05USD for recyclable paper bags and 0.10USD for reusable bags must be applied. In 2016, the charge on paper bags was increased to 0.10USD (Bag Laws, 2017).
	Encinitas, CA	Ban & Levy	2015	Plastic bags less than 57 microns have been banned in the city since March 2015. Reusable bags and recycled paper bags may be provided as alternatives. However, paper bags shall only be provided if a 0.10USD fee is applied. Customers may get a 0.05USD rebate for every reusable bag used per transaction (Bag Laws, 2017).
	Fairfax, CA	Ban	2008	A complete ban on plastic bags is in effect in Fairfax since 2008. Stores may only provide recyclable paper bags or reusable bags made of cloth or other machine washable fabric (Bag Laws, 2017).
	Fort Bragg, CA	Ban & Levy	2012	In October 2012, plastic bags less than 57 microns were banned in Fort Bragg. Stores may provide recycled paper bags and/or reusable bags for no less than 0.10USD (Bag Laws, 2017).
	Foster City, CA	Ban & Levy	2013	In January 2013, the Foster City Council adopted a resolution to join the San Mateo County in banning plastic and other single use bags at the point of sale. The ordinance prohibits retail establishments from providing plastic bags less than 57 microns thick. Alternatives such as reusable bags and recyclable paper bags are allowed, however a fee must be applied for these items. The fee consisted of 0.10US but was increased to 0.25USD in 2015. The ordinance took effect on April 22 nd , 2013 (Bag Laws, 2017).
	Glendale, CA	Ban & Levy	2013	In July 2013, a ban on plastic bags less than 57 microns became effective in farmer's markets, larger grocer and food marts. The ban was extended to smaller grocers, liquor stores, convenience stores, pharmacies and vendors at City sponsored events, City facilities or City properties in January 2014. Establishments may provide recyclable paper bags for at least 0.10USD or reusable bags for purchase (or for free) (Bag Laws, 2017).
	Gonzales, CA	Ban & Levy	2015	Since January 2015, plastic bags less than 100 microns have been banned in retail establishments throughout the city. Stores may however provide

				recycled paper bags and/or reusable bags for no less than 0.25USD (Bag Laws, 2017).
	Grass Valley, CA	Ban	2015	Plastic bags less than 57 microns have been banned since January 1 st , 2015. Stores are not mandated to charge for the alternative bags they provide, however, they are encouraged to do so (Bag Laws, 2017).
	Greenfield, CA	Ban & Levy	2015	Greenfield retail establishments are prohibited from providing plastic bags less than 100 microns thick since February 2015. Stores may make available to their customers recycled paper bags or reusable bags for no less than 0.25USD (Bag Laws, 2017).
	Half Moon Bay, CA	Ban & Levy	2013	No retail establishment in Half Moon Bay may provide plastic bags less than 57 microns thick to their customers. Only recycled paper bags or reusable bags may be made available if the retailer charges a minimum of 0.10USD. In January 2015, the charge was increased to 0.25USD (Bag Laws, 2017).
	Hercules, CA	Ban & Levy	2015	Since March 2015, no retail establishment may provide plastic bags less than 57 microns thick to their customers at checkouts. They shall provide or make available recycled paper bags or reusable bags for no less than 0.10USD (Bag Laws, 2017).
	Indio, CA	Ban & Levy	2015	Plastic bags less than 57 microns are banned in stores within city limits of Indo. All store must provide or make available recyclable paper bags or reusable bags to their customers. A fee of at least 0.10USD must be applied for each recycled paper bag provided to a customer (Bag Laws, 2017).
	King City, CA	Ban & Levy	2015	Since January 2015, plastic bags less than 100 microns thick are banned from all retail establishments in King City. Stores may only sell for a minimum of 0.10USD recycled paper bags or reusable bags to their customers (Bag Laws, 2017).
	LA County, CA	Ban & Levy	2012	Plastic bags less than 57 microns thick have been banned in retail establishments throughout LA County since January 2012. All stores must provide reusable bags, either for sale or at no charge, as well as recycled paper bags for no less than 0.10USD (Bag Laws, 2017).

Lafayette, CA	Ban & Levy	2015	Plastic bags less than 57 microns thick have been banned in Lafayette since July 2015. Only recycled paper bags, at a minimum fee of 0.10USD, or reusable bags may be provided to customers for purchase (Bag Laws, 2017).
Laguna Beach, CA	Ban & Levy	2013	Since January 2013, no retail establishment shall provide plastic bags less than 57 microns thick. Recycled paper bags may only be provided if a 0.10USD fee is collected. Reusable bags may also be provided to customers, including plastic bags more than 57 microns thick (Bag Laws, 2017).
Larkspur, CA	Ban & Levy	2014	Plastic bags below 57 microns have been banned in Larkspur since November 2014. Only recyclable paper bags or reusable bags can be provided to customers. Recyclable paper bags may only be provided if a 0.10USD fee is applied whereas reusable bags may only be provided if a 0.05USD is applied (Bag Laws, 2017).
Long Beach, CA	Ban & Levy	2012	As of January 2012, no store shall provide plastic bags less than 57 microns thick. Only recyclable paper bags or reusable bags may be provided to customers. There is no mandatory fee on reusable bags, however, a 0.10USD minimum fee is applied on all recyclable paper bags provided to customers (Bag Laws, 2017).
Los Altos, CA	Ban & Levy	2013	Plastic bags less than 57 microns have been banned in Los Altos since July 2013. Retail establishments may only make recycled paper bags or reusable bags available at a minimum fee of 0.10USD. This fee was increased to 0.25USD in January 2015 (Bag Laws, 2017).
Los Angeles, CA	Ban & Levy	2014	Plastic bags less than 57 microns thick have been banned in Los Angeles since January 2014. Stores shall provide or make available only recyclable paper bags or reusable bags. No mandatory fee is applied to reusable bags. However, customers are charged 0.10USD for each recyclable paper bags used (Bag Laws, 2017).
Los Gatos, CA	Ban & Levy	2014	Since February 2014, plastic bags less than 57 microns have been banned. Recycled paper bags and reusable bags may be made available for at least 0.10USD (Bag Laws, 2017).

	Malibu, CA	Ban	2008	No retail establishment, restaurant, vendor or non-profit vendor may provide plastic bags less than 57 microns since 2008 (Bag Laws, 2017).
	Manhattan Beach, CA	Ban	2012	A total ban on plastic bags became effective in Manhattan Beach in January 2012. Paper bags provided must be 100% recyclable whereas reusable bags must be made either of cloth or other machine washable fabric; or made of other durable material suitable for reuse (Bag Laws, 2017).
	Marin County, CA	Ban & Levy	2012	A total ban on plastic bags has been in effect in Marin County since January 2012. Reusable bags must be made available for purchase whereas recycled paper bags may only be provided in a 0.05USD charge is applied (Bag Laws, 2017).
	Martinez City, CA	Ban & Levy	2015	Plastic bags less than 57 microns thick have been banned since January 2015. A 0.10USD minimum charge is placed on carryout bags distributed at retail and restaurant establishments (Bag Laws, 2017).
	Mendocino County, CA	Ban & Levy	2013	Plastic bags less than 57 microns thick have been banned since January 2013. Recyclable paper bags and/or reusable bags, including plastic bags more than 57 microns thick may be made available for a minimum charge of 0.10USD (Bag Laws, 2017).
	Menlo Park, CA	Ban & Levy	2013	In April 2013, the Menlo Park City Council adopted a resolution to join the San Mateo County in banning plastic and other single use bags at the point of sale. The ordinance prohibits retail establishments from providing plastic bags less than 57 microns thick. Alternatives such as reusable bags and recyclable paper bags are allowed, however a fee must be applied for these items. The fee consisted of 0.10US in 2012 but was increased to 0.25USD in 2015 (Bag Laws, 2017).
	Mill Valley, CA	Ban & Levy	2014	In 2013, the Mill Valley City Council adopted an ordinance regulating the provision of single-use bags at grocery stores, pharmacies and convenience stores. The ordinance took effect in April 2014 and banned plastic bags less than 57 microns thick. Stores a required to charge 0.10USD for each recyclable paper bag provided at the point of sale and may also provide reusable bags for purchase. In 2015, the ordinance was expanded to all retail stores and businesses (Bag Laws, 2017).

Millbrae, CA	Ban & Levy	2012	Since September 2012, plastic bags less than 57 microns thick have been banned in Millbrae. Retail establishments are required to make available for sale a recycled paper bag for at least 0.10USD as well as reusable bags for purchase (Bag Laws, 2017).
Monrovia, CA	Ban & Levy	2014	Ordinance No. 2014-05 states that no store shall provide any customer plastic bags less than 57 microns thick. Only recyclable paper bags or reusable bags may be provided or made available. However, recyclable paper bags may only be provided if a 0.10USD charge is applied (Bag Laws, 2017).
Monterey, CA	Ban & Levy	2012	In June 2012, an ordinance prohibiting the provision of plastic bags less than 57 microns thick came into effect. The ordinance also requires retailers that provide recycled paper bags to charge a minimum 0.10USD. The minimum charge was increased to 0.25USD in 2013 (Bag Laws, 2017).
Monterey County, CA	Ban & Levy	2015	In March 2015, the County of Monterey banned plastic bags less than 100 microns thick. Recycled paper bags or reusable bags may be made available for a minimum fee of 0.10USD. The fee was increased to 0.25USD in 2016 (Bag Laws, 2017).
Morgan Hill City, CA	Ban & Levy	2014	In October 2013, the City Council of Morgan Hill banned the provision of plastic bags less than 57 microns thick and implemented a mandatory 0.10USD minimum fee on recyclable paper bags and reusable bags. The ordinance took effect in April 2014 (Bag Laws, 2017).
Mountain View, CA	Ban & Levy	2013	As of April 2013, no retail establishment shall provide plastic bag less than 57 microns thick to their customers. Only recycled paper bags and reusable bags may be made available for a minimum fee of 0.10USD. The fee was increased to 0.25USD in 2015 (Bag Laws, 2017).
Nevada City, CA	Ban & Levy	2015	As of January 2015, no retail establishment may provide plastic bags less than 57 microns thick. Recycled paper bags and reusable bags may be made available for a minimum charge of 0.10USD (Bag Laws, 2017).

Novato, CA	Ban & Levy	2014	As of April 2014, only recyclable paper bags and reusable bags may be provided to customers at the point of sale for a minimum fee of 0.10USD. Plastic bags less than 57 microns thick have been banned (Bag Laws, 2017).
Ojai City, CA	Ban & Levy	2012	Since July 2012, no retail establishment may provide plastic bags less than 57 microns thick. Only recyclable paper bags and reusable bags may be provided. A minimum fee of 0.10USD must be applied to every recycled paper bag provided (Bag Laws, 2017).
Pacific Grove, CA	Ban & Levy	2015	Plastic bags less than 100 microns thick have been banned in Pacific Grove since March 2015. Retail establishments are required to charge at least 0.10USD for every recyclable paper bag provided to customers. The provision of reusable bags at a reasonable price is strongly encouraged (Bag Laws, 2017).
Pacifica, CA	Ban & Levy	2013	In accordance with the San Mateo County single use bag ban ordinance, the city of Pacifica banned plastic bags less than 57 microns thick in April 2013. Recycled paper bags and reusable bags must be made available at a minimum fee of 0.10USD. The fee was increased to 0.25USD in 2015 (Bag Laws, 2017)
Palm Desert, CA	Ban & Levy	2015	Since April 2015, no store in Palm Desert may provide plastic bags less than 57 microns thick. Only reusable bags may be provided. A 0.10USD minimum charge must be applied to every reusable paper bags provided (Bag Laws, 2017).
Palm Springs, CA	Ban & Levy	2014	Palm Springs banned the provision of plastic bags less than 57 microns thick in May 2014. All stores are required to provide or make available recyclable paper bags and/or reusable bags. A minimum charge of 0.10USD must be applied for every recyclable paper bag provided to customers (Bag Laws, 2017).
Palo Alto, CA	Ban	2009	Palo Alto banned the distribution of plastic bags less than 57 microns in supermarkets within the city in September 2009. Only reusable bags and/or recyclable paper bags may be provided (Bag Laws, 2017).

Pasadena, CA	Ban & Levy	2012	Plastic bags less than 57 microns have been banned. Only recyclable paper bags and reusable bags may be provided to customers in all stores within city limits. A mandatory 0.10USD minimum fee is applied on all recyclable paper bags provided to customers (Bag Laws, 2017).
Pico Rivera, CA	Ban & Levy	2016	Plastic bags less than 57 microns thick have been banned since July 2016, just a few months before the state law came into effect. Only reusable bags and recyclable paper bags may be provided to customers at the point of sale. A mandatory 0.10USD minimum charge must be applied on all recyclable paper bags provided (Bag Laws, 2017).
Pittsburg, CA	Ban & Levy	2014	Since January 2014, plastic bags less than 57 microns thick have been banned in retail establishments within the city. Reusable bags are highly encouraged, whereas recyclable paper bags may be purchased at checkouts for a minimum charge of 0.10USD (Bag Laws, 2017).
Pleasant Hills, CA	Ban & Levy	2015	A ban on plastic bags less than 57 microns thick came into effect in February 2015. The ban applies to all restaurants, grocery stores, pharmacies and retail stores. Stores are required to provide recyclable paper bags for at least 0.10USD and are highly encouraged to provide reusable bags for a fee (Bag Laws, 2017).
Portola Valley, CA	Ban & Levy	2013	Ordinance No. 2013-398 applies the San Mateo County single-use bag ban ordinance within city limits. Therefore, plastic bags less than 57 microns thick have been banned. Stores that provide reusable bags and/or recyclable paper bags are required to charge 0.10USD per bag. The minimum charge was increased to 0.25USD in January 2015 (Bag Laws, 2017).
Redwood, CA	Ban & Levy	2013	In October 2013, a ban on plastic bags less than 57 microns thick came into effect in Redwood. Stores that provide reusable bags and/or recyclable paper bags are required to charge 0.10USD per bag. The minimum charge was increased to 0.25USD in January 2015 (Bag Laws, 2017).
Richmond, CA	Ban & Levy	2014	Since January 2014, no retail establishment may provide plastic bags less than 57 microns thick to customers. Only recycled paper bags and reusable bags may be provided. However, a minimum fee of 0.05USD must be applied on all recycled paper bags provided to customers and 0.10USD on

				reusable bags. The 0.05USD fee was increase to 0.10USD in 2016 (Bag Laws, 2017).
Saint Helena, CA	Ban & Levy	2015		Since January 1 st , 2015, plastic bags less than 57 microns thick have been banned within city limits. Recyclable paper bags may be made available at a minimum fee of 0.10USD whereas the use and provision of reusable bags is highly encouraged (Bag Laws, 2017).
Salinas, CA	Ban & Levy	2015		Plastic bags less than 100 microns thick have been banned since January 2015. Recycled paper bags and/or reusable bags must be made available to customers at a minimum charge of 0.10USD (Bag Laws, 2017).
San Anselmo, CA	Ban & Levy	2015		Plastic bags less than 57 microns thick were banned in January 2015. Only reusable bags and reusable bags may be made available to customers for a minimum fee of 0.10USD (Bag Laws, 2017).
San Bruno, CA	Ban & Levy	2013		According to Ordinance 1455, which took effect in April 2013, plastic bags less than 57 microns thick have been banned. Stores that provide reusable bags and/or recyclable paper bags are required to charge 0.10USD per bag. The minimum charge was increased to 0.25USD in January 2015. (Bag Laws, 2017).
San Carlos, CA	Ban & Levy	2013		According to Ordinance 1810, which took effect in July 2013, plastic bags less than 57 microns thick have been banned. Stores that provide reusable bags and/or recyclable paper bags are required to charge 0.10USD per bag. The minimum charge was increased to 0.25USD in January 2015. (Bag Laws, 2017).
San Francisco, CA	Ban & Levy	2007		The San Francisco bag ban was first passed in 2007 and was the first major law regulating carry out bags in the U.S. It focused on banning plastic bags less than 57 microns thick. In 2012, amendments were made to the ban in order to institute a 0.10USD fee of permitted bags as well as expand stores covered by the ban (One Bag at a Time, 2017).
San Jose, CA	Ban & Levy	2012		No retail establishment may provide plastic bags less than 57 microns thick since January 2012. Reusable bags may be made available by retail establishments as well as recyclable paper bags. At first, a mandatory

				minimum charge of 0.10USD was applied on all recyclable paper bags. The charge was increased to 0.25USD in 2014 (Bag Laws, 2017).
San Luis Obispo County, CA	Ban & Levy	2012		As of September 1 st , 2012, single-use plastic bags less than 57 microns have been banned in stores throughout the county. Recyclable paper bags as well as reusable bags, including reusable plastic bags, continue to be allowed, however customer must be charged 0.10USD minimum for these items (Bag Laws, 2017).
San Mateo County, CA	Ban & Levy	2012		On October 23 rd , 2012, the San Mateo County Board of Supervisors approved an Environmental Impact Report and adopted an ordinance banning single-use carryout bags from stores, while requiring stores that provide reusable bags and/or recyclable paper bags to charge 0.10USD per bag. The minimum charge was increased to 0.25USD in January 2015. 18 cities within the county have therefore added single-use plastic bag ordinances in their municipal codes (Bag Laws, 2017).
San Pablo, CA	Ban & Levy	2014		Plastic bags less than 57 microns thick have been banned. Only recycled paper bags and reusable bags may be made available to customers. However, at first these bags must be provided at a minimum charge of 0.05USD. The charge was increased to 0.10USD in 2016 (Bag Laws, 2017).
Santa Barbara, CA	Ban & Levy	2014		No store shall provide customers with plastic bags less than 57 microns thick since April 2014. Only recyclable paper bags and reusable bags may be made available at the point of sale. No mandatory fee is required on reusable bags however, recyclable paper bags may only be provided if 0.10USD is charged for the item (Bag Laws, 2017).
Santa Clara, CA	Ban & Levy	2014		No retail establishment may provide plastic bags less than 57 microns thick since December 2014. Only recycled paper bags or reusable bags may be made available, but at a fee of no less than 0.10USD (Bag Laws, 2017).
Santa Clara County, CA	Ban & Levy	2012		Plastic bags less than 57 microns thick are banned from retail establishments since January 2012. Only reusable bags and recycled paper bags may be provided to customers at point of sale. Retail establishments are prohibited from providing free recycled plastic bags and reusable bags may only be

				provided free of charge as part of a time-limited store promotion (Bag Laws, 2017).
Santa Cruz, CA	Ban & Levy	2013		Ordinance 2012-08 states that plastic bags less than 57 microns thick shall not be provided to customers in retail establishments. Only recyclable paper bags and reusable bags may be provided. A mandatory 0.10USD charge is also required on all recyclable paper bags (Bag Laws, 2017).
Santa Cruz County, CA	Ban & Levy	2012		Retail establishments are prohibited from providing plastic bags less than 57 microns thick since March 2012. Only recyclable paper bags and reusable bags may be made available at the point of sell for a charge of at least 0.25USD (Bag Laws, 2017).
Santa Monica, CA	Ban & Levy	2011		Ordinance 2348, which came into effect in September 2011, prohibits retail establishments from providing plastic bags less than 57 microns thick. Only recycled paper bags and reusable bags may be provided. However, recycled paper bags may only be provided if a 0.10USD minimum charge is applied (Bag Laws, 2017).
Sausalito, CA	Ban & Levy	2014		According to Ordinance No. 1216, plastic bags less than 57 microns thick have been banned within city limits. Only recyclable paper bags and reusable bags may be provided but only when a 0.10USD minimum charge is applied on these items (Bag Laws, 2017).
Seaside, CA	Ban & Levy	2015		Plastic bags less than 100 microns thick were banned in September 2015. Only recycled paper bags and reusable bags may be provided. However, a mandatory 0.10USD charge must be applied for every bag provided to customers (Seaside City Council, 2014).
Solana Beach, CA	Ban & Levy	2012		Plastic bags less than 57 microns thick have been banned since September 2012. Only reusable bags and recycled paper bags may be provided to customers at the point of sale. Retail establishments are highly encouraged to provide incentives for the use of reusable bags and are also required to charge at least 0.10USD for recycled paper bags (Bag Laws, 2017).
Soledad, CA	Ban & Levy	2015		Ordinance No. 686, which became effective in May 2015, prohibits retail establishments from providing plastic bags less than 100 microns thick.

				Recycled paper bags and reusable bags may be made available for a minimum fee of 0.10USD (Bag Laws, 2017)
Sonoma County, CA	Ban & Levy	2014		In February 2014, Ordinance No. 2014-2 was passed, establishing a waste reduction program for carryout bags. Beginning September 2014, retail establishments in the county have stopped providing single-use plastic bags (less than 57 microns thick) and charge at least 0.10USD for recyclable paper bags (Bag Laws, 2017).
South Lake Tahoe, CA	Ban	2014		Plastic bags less than 57 microns thick were banned in January 2014 (Bag Laws, 2017).
South Padre Island, CA	Ban	2012		A total bag on plastic bags took effect in January 2012 (Bag Laws, 2017).
South San Francisco, CA	Ban & Levy	2013		Plastic bags less than 57 microns thick have been banned since April 2013. Only reusable bags or recycled plastic bags may be made available. Stores that provide these bags are required to charge 0.10USD per bag. The minimum charge was increased to 0.25USD in January 2015 (Bag Laws, 2017).
Sunnyvale, CA	Ban & Levy	2012		Plastic bags less than 57 microns were banned in June 2012. Only recyclable paper bags and reusable bags may be provided at the point of sale, but only at a minimum fee of 0.10USD (Bag Laws, 2017).
Truckee, CA	Ban & Levy	2014		Plastic bags less than 57 microns have been banned since June 2014. Only recycled paper bags and reusable bags may be made available at the point of sale, but a minimum fee of 0.10USD must be applied (Bag Laws, 2017).
Ukiah, CA	Ban & Levy	2012		As of November 2012, plastic bags less than 57 microns thick have been banned in large retailers. The ban was extended to all other retailers in November 2013. Only recycled paper bags and reusable bags may be provided, but for no less than 0.10USD (Bag Laws, 2017).
Walnut Creek, CA	Ban & Levy	2014		Plastic bags less than 57 microns thick were banned from all retailers in September 2014. All retail establishments are required to make reusable bags available for purchase and any retail establishment that provides recycled

				paper bags must charge at least 0.10USD for these bags (City of Walnut Creek, 2017).
West Hollywood, CA	Ban & Levy	2013		Ordinance No. 12-898 states that plastic bags less than 57 microns thick may not be provided in retail establishments. Reusable bags are required to be made available to customers for sale or at no charge, whereas recyclable paper bags may be made available at no less than 0.10USD (Bag Laws, 2017).
Aspen, CO	Ban & Levy	2012		Grocery stores are prohibited from providing plastic bags less than 57 microns thick to their customers. They may provide reusable bags and must charge 0.20USD for every disposable paper bag provided to customers (Bag Laws, 2017).
Avon, CO	Ban & Levy	2018		As of May 2018, plastic bags less than 57 microns thick will be banned throughout the city. Retailers will only be allowed to provide reusable bags or disposable paper bags. The paper bags will be subject to a 0.10USD fee (Bag Laws, 2017).
Boulder City, CO	Levy	2013		In November 2012, a bag fee ordinance was adopted. The ordinance requires grocers to charge 0.10USD for every plastic bag less than 57 microns thick, used by customers. The fee took effect in July 2013 (Boulder City, 2017).
Breckenridge, CO	Levy	2013		All retail stores are required to charge 0.10USD for every disposable bag used by customers. These include plastic bags less than 57 microns thick (Bag Laws, 2017).
Crested Butte, CO	Ban	2018		As of September 2018, retailers will only be allowed to provide their customers with reusable bags or recyclable paper bags. Plastic bags less than 57 microns thick will be banned (Bag Laws, 2017).
Telluride, CO	Ban & Levy	2011		A total ban on plastic bags in grocery stores is in effect since March 2011. Grocers may only provide recyclable paper bags for no less than 0.10USD as well as reusable bags to their customers (Bag Laws, 2017).
Town of Carbondale, CO	Ban & Levy	2012		Grocery stores are prohibited from providing plastic bags less than 57 microns thick to their customers but may make reusable bags available.

				Disposable paper bags may also be provided, but at a fee of 0.20USD per bag (Bag Laws, 2017).
Westport, CT	Ban	2008		Plastic bags less than 57 microns are banned in Westport. Retail establishments may only provide reusable bags or recyclable paper bags to their customers at checkouts.
Coral Gable, FL	Ban	2018		A ban on the use of plastic bags in Coral Gable was approved in May 2017. Retail establishments have been given 12-months to comply with the ban. In the meantime, education campaigns will be performed to ensure full compliance in May 2018 (Bag Laws, 2017).
Hawaii County, HI	Ban	2013		Plastic bags have been banned on the Big Island since January 2013. Only reusable bags made of cloth, or other machine washable fabric, as well as reusable bags made of paper may be provided to customers (Bag Laws, 2017).
Honolulu County, HI	Ban & Levy	2012		Businesses may only provide reusable bags, compostable plastic bags or recyclable paper bags to their customers at the point of sale for at least 0.15USD. Plastic bags less than 57 microns are therefore banned. All plastic bags will be banned by 2020 (Bag Laws, 2017).
Kauai County, HI	Ban	2011		Since January 2011, retail establishments must only provide as checkout bags: recyclable paper bags, biodegradable bags and/or reusable bags. Plastic bags less than 57 microns thick were henceforth banned (Bag Laws, 2017).
Maui County, HI	Ban	2011		Plastic bags were banned in the county in January 2011. Only recyclable paper bags and reusable bags may be provided to customers. According to the ordinance, reusable bags are made of cloth or other washable fabric, or durable material suitable for reuse (Bag Laws, 2017).
Chicago, IL	Ban & Levy	2015		Plastic bags less than 57 microns thick were banned in August 2015. Only reusable bags, recyclable paper bags and/or commercially compostable plastic bags may be provided. An amendment was made in 2016, effective in February 2017, where a 0.07USD tax was imposed on paper and plastic checkout bags (Bag Laws, 2017).

Evanston, IL	Ban	2015	Plastic bags less than 57 microns thick have been banned in Evanston. Stores may only provide reusable bags, recyclable paper bags and/or commercially compostable plastic bags (Bag Laws, 2017).
Adams, MA	Ban	2017	Plastic bags less than 63 microns thick have been banned in retail establishments throughout the city since March 2017. Retail establishments may provide reusable or recyclable thick plastic, paper, fabric or other types of bags (Bag Laws, 2017).
Amherst, MA	Ban	2017	A ban on plastic bags less than 76 microns thick have been banned in the Town of Amherst since January 2017. Businesses may provide biodegradable bags, reusable bags, compostable bags or recyclable paper bags to their customers (Bag Laws, 2017).
Aquinna, MA	Ban	2017	As of January 1 st , 2017, plastic bags less than 100 microns thick have been banned in Aquinna. Stores may provide recyclable paper bags and reusable bags at checkouts (Bag Laws, 2017).
Arlington, MA	Ban	2018	Plastic bags less than 100 microns thick will be banned at all retail stores in Arlington as of March 2018. Recyclable paper bags and reusable bags as defined in the ordinance may be provided to customers at checkout (Bag Laws, 2017).
Athol, MA	Ban	2018	Plastic bags with a wall thickness of less than 63 microns are banned in grocery stores as of January 2018. Grocery stores may provide reusable bags made of cloth, fabric or other durable material (Bag Laws, 2017).
Barnstable, MA	Ban	2016	Plastic bags less than 76 microns thick have been banned throughout Barnstable since September 2016. Establishments may and are strongly encouraged to distribute paper bags, reusable bags and boxes available to customers with or without charge and educate their staff to promote reusable bags and post signs encouraging customers to use washable reusable bags (Bag Laws, 2017).
Bedford, MA	Ban	2017	In October 2017, a ban on plastic bags less than 63 microns thick came into effect. Retail stores, supermarkets, general department stores as well as

				restaurant and takeout retail may provide reusable bags made of thick plastic, cloth, fabric or other durable materials (Bag Laws, 2017).
	Boston, MA	Ban & Levy	2018	In November 2017, a ban on plastic bags less than 76 microns thick was approved. The ban will take effect in December 2018. Compostable plastic bags, recyclable paper bags and reusable bags will be permitted, however, a 0.05USD mandatory fee must be applied to each bag provided to customers (Bag Laws, 2017).
	Bourne, MA	Ban	2018	A ban on plastic bags less than 76 microns came into effect in January 2018. Customers are encouraged to bring their own reusable shopping bags to stores. Establishments may provide reusable bags at no charge or charge a reasonable fee for each paper or other bag as they so desire. Establishments are strongly encouraged to make reusable bags available for sale to customers at a reasonable price (Bag Laws, 2017).
	Bridgewater, MA	Ban	2016	Plastic bags less than 63 microns thick may not be distributed, used or sold for checkout or other purposed at any retail establishment within city limits. Customers are encouraged to bring their own reusable or biodegradable shopping bags to stores. Retail establishments may provide reusable or recyclable thick plastic, paper, fabric or other types of bags at no charge, or charge a fee for paper or other bags, as they so desire. Retail establishments are strongly encouraged to make reusable bags available for sale to customers at a reasonable price (Bag Laws, 2017).
	Brookline, MA	Ban	2013	Plastic bags less than 57 microns thick have been banned in retail establishments since December 2013. Recyclable paper bags and/or reusable bags made of cloth or other machine washable fabric, or thick plastic, may still be provided to customer at checkout (Bag Laws, 2017).
	Cambridge, MA	Ban & Levy	2016	In March 2016, the City of Cambridge banned plastic bags less than 76 microns thick. Retail establishments, which such as restaurants, grocery stores and household goods stores, may provide recyclable paper bags, reusable bags or compostable plastic bags to their customers, but they must charge a minimum fee of 0.10USD for each bag provided (Bag Laws, 2017).

Chilmark, MA	Ban	2017	Plastic bags less than 100 microns thick have been banned since January 2017. Retail establishments may provide recyclable paper bags or reusable bags to their customers at checkouts (Bag Laws, 2017).
Concord, MA	Ban	2016	Plastic bags less than 63 microns thick may not be provided at retail or grocery stores within city limits. Customers are encouraged to bring their own reusable or biodegradable shopping bags to stores. Retail or grocery stores are strongly encouraged to make reusable checkout bags available for sale to customers at a reasonable price (Bag Laws, 2017).
Dennis, MA	Ban	2018	Starting January 1 st , 2018, plastic bags less than 63 microns thick may not be provided at any establishment within the town of Dennis (Bag Laws, 2017).
Duxbury, MA	Ban	2018	Only reusable bags and recyclable paper bags may be provided at all establishments in Duxbury. Plastic bags less than 76 microns thick have been banned since early 2017 (Bag Laws, 2017).
Edgartown, MA	Ban	2017	Plastic bags less than 100 microns thick have been banned since January 1 st , 2017 throughout city limits. Stores may provide recyclable paper bags and reusable bags to their customers (Bag Laws, 2017).
Framingham, MA	Ban	2018	Grocery and retail stores are prohibited from providing plastic bags less than 63 microns thick at their checkouts. Customer are encouraged to bring their own reusable bags and retailers are strongly encouraged to make reusable checkout bags available for sale to customers at a reasonable price (Bag Laws, 2017).
Grafton, MA	Ban	2018	In July 2018, thin single-use plastic bags will be banned. However, the city ordinance does not define “thin single-use plastic bags” and therefore the exact thickness of the banned bags remains unknown. Retail establishments will be required to make reusable bags available for sale to customers at a reasonable price (Bag Laws, 2017).
Great Barrington, MA	Ban	2014	Plastic bags less than 63 microns thick were banned in March 2014. Retail establishments may provide reusable or recyclable thick plastic, paper, fabric or other types of bags at no charge or charge a fee for paper or other bags, as

				they see fit. They are also strongly encouraged to make reusable bags available for sale to customers at a reasonable price (Bag Laws, 2017).
Hamilton, MA	Ban	2016		Retail establishments are prohibited from providing plastic bags less than 76 microns thick to their customers. They may, however, provide reusable bags made of cloth or other washable fabric; durable plastic thicker than 63 microns; or some other durable non-toxic material (Bag Laws, 2017).
Harwich, MA	Ban	2016		Plastic bags less than 63 microns thick cannot be provided at any establishment within the town of Harwich. The use of reusable bags is strongly encouraged (Bag Laws, 2017).
Ipswich, MA	Ban	2017		Thin-film single-use bags (less than 63 microns) shall not be distributed or sold from any retail establishment within the Town of Ipswich. Customers are encouraged to take their own reusable or biodegradable shopping bags to stores. Retail establishments may provide reusable or biodegradable, thick-plastic, paper, fabric, or other types of bags at no charge, or impose a fee for paper or other bags, as they so desire. Retail establishments are strongly encouraged to make reusable bags available for sale to customers at a reasonable price (Bag Laws, 2017).
Lee, MA	Ban	2017		As of May 2017, no establishment can provide any plastic bags that are made of Polyethylene. Establishments may only provide reusable shopping bags or recyclable paper bags to their customers (Bag Laws, 2017).
Manchester, MA	Ban	2013		In July 2013, plastic bags less than 63 microns were banned in Manchester (Bag Laws, 2017).
Marblehead, MA	Ban	2015		No retail establishment may provide plastic bags less than 76 microns thick to their customers. Only recyclable paper bags, reusable shopping bags, compostable plastic bags or biodegradable plastic bags may be provided at checkouts (Bag Laws, 2017).
Mashpee, MA	Ban	2018		A ban on plastic bags less than 100 microns thick was approved in October 2016. Retail establishments were given until January 2018 to comply with the ban (Bag Laws, 2017).

Natick, MA	Ban	2017	Retail establishments may not provide plastic bags less than 50 microns thick in Natick. However, they may provide recyclable paper bags, reusable shopping bags made of cloth or other washable fabric or a plastic bag with a thickness of at least 50 microns thick (Bag Laws, 2017).
Newburyport, MA	Ban	2015	Through the “Thin-film plastic bags reduction ordinance”, plastic bags less than 76 microns thick have been banned in retail establishments throughout the town (Bag Laws, 2017).
Newton, MA	Ban	2015	Plastic bags less than 76 microns thick were banned from retail establishments in June 2015. Reusable shopping bags or recyclable paper bags may be provided to customers at checkouts for a fee or free of charge, as the retailer sees fit (Bag Laws, 2017).
Northampton, MA	Ban	2016	The City of Northampton banned plastic bags less than 76 microns thick in January 2016. Retail establishments may only provide reusable or biodegradable bags, or compostable plastic bags (Bag Laws, 2017).
Plymouth, MA	Ban	2018	No establishment in the Town of Plymouth may provide plastic bags less than 76 microns thick as of January 2018. Only reusable shopping bags and recyclable paper bags may be provided at checkouts (Bag Laws, 2017).
Provincetown, MA	Ban	2015	Provincetown banned the distribution of plastic bags less than 38 microns thick in all establishments in April 2015. Customers are encouraged to bring their own reusable shopping bags to Establishments. Establishments may provide paper or reusable bags at no charge or charge a fee which would be kept by the Establishment as they so desire (Bag Laws, 2017).
Salem, MA	Ban	2018	In February 2017, a ban on plastic bags less than 100 microns thick was approved. As of January 2018, the plastic bags shall not be distributed in retail establishments (Bag Laws, 2017).
Sandwich, MA	Ban	2017	A ban on plastic bags less than 100 microns thick was approved in January 2017 and took effect in November 2017. Retail establishments are therefore not permitted to distribute these bags but can make available reusable shopping bags (Bag Laws, 2017).

	Shrewsbury, MA	Ban	2017	A ban on plastic bags less than 100 microns thick was approved in May 2016 and took effect in July 2017. Retail establishments are therefore not permitted to distribute these bags but can make available reusable shopping bags or recyclable paper bags (Bag Laws, 2017).
	South Hadley, MA	Ban	2018	A ban on plastic bags less than 100 microns thick was approved in May 2017 and is expected to take effect in July 2018. Retail establishments will therefore not be permitted to distribute these bags. However, they may distribute paper bags that contain no polymers derived from fossil fuels and are intended for single use and will decompose in a natural setting to an environmentally beneficial material at a rate comparable to other biodegradable materials such as paper, leaves, and food waste as well as reusable bags that have a thickness greater than 100 microns and are specifically designed for multiple use and are made of thick recyclable plastic, cloth, fabric or other durable materials that do not decompose into harmful chemical components. A reusable bag may be recyclable or compostable and is specifically designed and manufactured for multiple reuse (Bag Laws, 2017).
	Sudbury, MA	Ban	2018	In May 2017, a ban on plastic bags less than 100 microns thick was approved. The ban will take effect in January 2018. Retail establishments will only be allowed to provide recyclable paper bags or reusable bags at their checkouts (Bag Laws, 2017).
	Tisbury, MA	Ban	2017	Since January 2017, no store can provide plastic bags less than 100 microns thick. Only recyclable paper bags and reusable bags may be provided to customers at the point of sale (Bag Laws, 2017).
	Town of Chatham, MA	Ban	2017	Plastic bags less than 63 microns thick have been banned since January 2017. Establishments may provide reusable bags at no charge or charge a reasonable fee for each paper or other bag as they desire. Establishments are strongly encouraged to make reusable bags available to customers at a reasonable price (Bag Laws, 2017).

Truro, MA	Ban	2016	As of June 2016, retail establishments may not provide plastic bags less than 38 microns thick. Retailers may provide paper or reusable bags as well as plastic bags with a wall thickness superior to 38 microns (Bag Laws, 2017).
Wayland, MA	Ban	2018	In May 2017, a ban on plastic bags less than 100 microns was approved and shall come into effect in January 2018. Retail establishments will only be allowed to provide reusable shopping bags or recyclable paper bags (Bag Laws, 2017).
Wellesley, MA	Ban	2017	Plastic bags less than 100 microns have been banned since January 2017. Recyclable paper bags and reusable shopping bags may still be provided at checkouts in retail establishments (Bag Laws, 2017).
Wellfleet, MA	Ban	2016	In January 2016, plastic bags less than 90 microns thick were banned in all retail establishments within city limits. Paper bags as well reusable bags or boxes may still be provided to customers (Bag Laws, 2017).
West Tisbury, MA	Ban	2017	Plastic bags less than 100 microns thick were banned from retail establishments in January 2017. Recyclable paper bags and reusable bags may be provided to customers (Bag Laws, 2017).
Williamstown, MA	Ban	2015	Williamston banned the distribution of plastic bags less than 100 microns in retail establishments in October 2015. Recyclable paper bags as well as reusable bags may be provided to customers at these retail areas in lieu (Bag Laws, 2017)
Chestertown, MD	Ban	2012	No retail establishment may provide customers with plastic bags less than 60 microns thick, except for restaurants involved in take-out business. Compostable plastic bags are permitted (Bag Laws, 2017).
Montgomery County, MD	Levy	2012	A tax in the amount of 0.05USD is levied and imposed on each customer for every carryout bag (including plastic bags) that a retail establishment provides to the customer (Bag Laws, 2017).
Belfast, ME	Ban	2018	Plastic bags less than 100 microns thick are to be banned as of January 2018 (Bag Laws, 2017).
Brunswick, ME	Ban	2017	In September 2017, a ban on plastic bags less than 100 microns thick started to be enforced (Bag Laws, 2017).

Falmouth, ME	Levy	2016	Businesses larger than 10,000 square feet are required as of April 2016 to charge a minimum fee of 0.05USD on all single-use carryout bags. These include compostable and biodegradable bags, including plastic bags less than 100 microns thick as well as paper bags. However, reusable bags, produce bags, product bags or bags provided by pharmacists to contain prescription drugs, and bags distribute at dry cleaning establishments are exempt from this fee (Bag Laws, 2017).
Freeport, ME	Ban & Levy	2016	In September 2016, plastic bags that do not meet all the criteria to be considered a reusable bag as defined by the city have been outlawed. Single-use paper bags may be provided if a 0.05USD fee is applied (Bag Laws, 2017).
Kennebunk, ME	Ban	2016	No plastic bag less than 76 microns thick can be distributed to customers in retail establishments within city limits. Retail establishments may provide customers with recyclable paper bags and reusable bags with or without a charge. Customers are encouraged to bring their own bags when shopping and retailers may choose to give rebates, discounts or incentives for to such customers (Bag Laws, 2017).
Portland, ME	Levy	2015	Stores are required to charge at least 0.05USD for every single-use carryout bag used by a customer. These bags include plastic bags less than 57 microns thick, compostable and biodegradable bags as well as paper bags (bag Laws, 2017).
Saco, ME	Ban	2017	A total ban on plastic bags came into effect in October 2017. All stores within city limits are permitted to provide a non-petroleum-based bag such as a paper bag, a reusable bag or a bag made from degradable resin compounds. In this ordinance, reusable bags are defined as bags manufacture for multiple reuse that are made of cloth, fiber or other machine washable fabric, but not plastic film (Bag Laws, 2017).
South Portland, ME	Levy	2016	As of March 2016, stores are required to charge a minimum 0.05USD fee for all single-use carryout bags provided to customers at checkouts. These include plastic bags less than 57 microns thick (Bag Laws, 2017).

Topsham, ME	Levy	2017	Stores have been required to charge a minimum fee of 0.05USD for every single-use carryout bag distributed to customers. These include plastic bags with a wall thickness inferior to 100 microns (Bag Laws, 2017).
York, ME	Ban	2016	Plastic bags less than 76 microns thick were banned in March 2016. Retail establishments may only provide reusable bags or recyclable paper bags. Customers are highly encouraged to bring their own reusable bags and may be offered a rebate, discount or incentive if they do so (Bag Laws, 2017).
Barrier Islands, NC	Ban	2009	Since 2009, no retailer can provide plastic bags to customers unless the bags are reusable (more than 57 microns thick) or compostable. Retailers may also provide recyclable paper bags (Bag Laws, 2017).
Longport, NJ	Ban	2015	Plastic bags less than 57 microns thick were banned in August 2015. Retailers may instead provide reusable bags made of cloth or other machine washable fabric or made of durable plastic that is at least 57 microns thick (Bag Laws, 2017).
Teaneck, NJ	Levy	2017	Plastic bags less than 76 microns thick, which are not biodegradable, are subject to a 0.05USD mandatory fee since June 2017 (Bag Laws, 2017).
Santa Fe, NM	Ban & Levy	2014	The Santa Fe reusable bag ordinance bans plastic bags less than 57 microns thick and requires retailers to charge a minimum 0.10USD fee for every recyclable paper bag provided to customers. The Use of reusable bags is highly encouraged (Bag Laws, 2017).
Silver City, NM	Ban	2015	In January 2015, plastic bags less than 57 microns thick were banned within city limits. Retail establishments may only provide reusable bags, recyclable paper bags and/or cardboard boxes to their customers with or without a fee (Bag Laws, 2017).
East Hampton, NY	Ban	2012	Retail establishments may only provide recyclable paper bags and/or reusable bags, which include plastic bags with a wall thickness superior to 57 microns (Bag Laws, 2017).
Hasting on the River, NY	Ban	2015	Plastic bags less than 57 microns thick have been banned since June 2015. Retailer may only provide recyclable paper bags and/or reusable shopping

				bags made of cloth or other fabric, and r durable plastic at least 57 microns thick (Bag Laws, 2017).
Larchmont, NY	Ban	2013		Retail establishments are only permitted to provide their customers with recyclable paper bags and/or reusable bags. Plastic bags less than 57 microns thick have been banned because they do not comply with the reusable bag definition established by the city (Bag Laws, 2017).
Long Beach, NY	Levy	2017		A fee of no less than 0.05USD is mandatory for every carryout bag provided to customers, whether it be made of plastic, paper or reusable materials (Bag Laws, 2017).
Mamaroneck, NY	Ban	2013		Plastic bags less than 57 microns have been banned in stores throughout Mamaroneck. Retailers may only provide reusable bags and/or recyclable paper bags at checkouts (Bag Laws, 2017).
New Castle, NY	Ban	2017		The New Castle Reusable Bag Law prohibits businesses from providing plastic bags less than 57 microns thick to their customers. Only reusable bags and/or recycled paper bags may be provided at checkouts (Bag Laws, 2017).
New Paltz Village, NY	Ban	2015		Plastic bags less than 57 microns thick were banned in April 2015. Retailers may provide only reusable bags and/or recyclable, biodegradable bags and/or recyclable paper bags as checkout bags to customers (Bag Laws, 2017).
New York City, NY	Levy (Failed)	2016		A minimum fee of 0.05USD on plastic bags was intended to come into effect in October 2016. In Early 2017, the New York City State Governor signed a bill that blocked the disposable bag fee (Bag Laws, 2017).
Patchogue Village, NY	Ban	2015		No retail establishment or public eating establishment shall provide a single-use carryout bag to a customer, at the check stand, cash register, point of sale or other point of departure. These include plastic bags with a wall thickness inferior to 57 microns. A retail establishment or public eating establishment may provide customers recycled paper bags or reusable bags (Bag Laws, 2017).
Rye, NY	Ban	2012		Since October 2012, retailers are prohibited from providing plastic bags less than 57 microns thick. Only reusable bags and/or recyclable paper bags may be distributed at checkouts (Bag Laws, 2017).

Southampton Town, NY	Ban	2015	Plastic bags less than 57 microns thick have been banned in retail establishments since April 2015. Only reusable bags and/or recyclable paper bags may be provided to customers at checkout (Bag Laws, 2017).
Southampton Village, NY	Ban	2012	Plastic bags less than 57 microns thick have been banned in retail establishments. Only reusable bags and/or recyclable paper bags may be provided to customers at checkout (Bag Laws, 2017).
Suffolk County, NY	Levy	2018	In September 2016, a law was approved that requires retail establishments such as convenience store, grocery stores and apparel stores, to charge a minimum 0.05USD fee for any carryout bag provided to customers. The law is set to take effect in January 2018 (Bag Laws, 2017).
Ashland, OR	Ban & Levy	2014	Plastic bags less than 100 microns thick cannot be provided in retail establishments. Retailers that choose to provide paper bags at the point of sale must provide a recyclable paper bag at a fee of no less than 0.10USD (Bag Laws, 2017).
City of Manzanita, OR	Ban	2017	In November 2017, single-use plastic bags were banned in the city of Manzanita. The related ordinance does not specify the exact thickness of these bags but mentions that they do not include reusable plastic bags (Bag Laws, 2017).
Corvallis, OR	Ban & Levy	2013	Plastic bags provided to customers must be at least 57 microns thick. Enforcement began January 1, 2013 for larger businesses (over 50 full-time equivalent employees (FTEs)) and July 1, 2013 for smaller businesses (50 or less FTEs). Thick plastic bags — 57 microns or greater — are considered reusable and may be provided with or without charge at the retailer’s discretion. Retailers that provide paper bags must provide recyclable paper bags at a fee of no less than 0.05USD (Bag Laws, 2017).
Eugene, OR	Ban & Levy	2013	Plastic bags provided to customers must be at least 100 microns thick. These are considered reusable bags. Retailers that provide paper bags must provide recyclable paper bags at a fee of no less than 0.05USD (Bag Laws, 2017).

Portland, OR	Ban	2011	Plastic bags less than 100 microns thick are banned in Portland. Retailers may provide recycled paper bags, reusable cloth bags and/or reusable plastic bags that are at least 100 microns thick and have handles (Bag Laws, 2017).
Barrington, RI	Ban	2013	In January 2013, plastic bags less than 57 microns were banned. Retail establishments could provide recyclable paper bags and/or reusable bags, including plastic bags thicker than 57 microns. However, in December 2015, the ban on plastic bags was amended to prohibit all plastic bags regardless of thickness, except thin barrier bags (Bag Laws, 2017).
Middletown, RI	Ban	2017	Ordinance 2017-9 states that no business establishment may provide or make available any plastic carryout bag at the point of sale, regardless of thickness. Establishments may provide recyclable paper bags and reusable bags made primarily of cloth or other nonwoven textiles or is constructed of multiple layers of insulation. The ordinance took effect in November 2017 (Bag Laws, 2017).
Newport, RI	Ban	2017	Since November 2017, plastic bags less than 100 microns thick have been banned in retail establishments within city limits (Bag Laws, 2017)
Austin, TX	Ban	2013	Business Establishments may not provide single-use carry-out bags to its customers or any person or entity and shall display signage to educate their customers about their bag options. They may, however, provide or sell reusable carry-out bags to its customers or any person. Reusable bags intended for multiple include paper bags with a wall thickness superior to 100 microns, recycled and recyclable paper bags, as well as bags made of cloth, other washable fabric or other durable materials whether woven or non-woven (Bag Laws, 2017).
Brownsville, TX	Levy; Ban	2011; 2017	A 1.00USD per-transaction fee for customers using plastic bags and other single-use carryout bags took effect in 2011. Following a lawsuit by the Texas Attorney General in 2016, the fee was scrapped. However, as of April 1 st , 2017, Business establishments are prohibited from providing plastic checkout bags less than 100 microns thick, but instead shall only provide reusable bags as checkout bags to their customers with or without charge (Bag Laws, 2017).

Dallas, TX	Levy (Failed)	2015	An environmental fee on plastic bags paper bags was intended to take effect in January 2015. However, the fee was repealed in June 2015 and carryout bags are once again delivered free of charge (Bag Laws, 2017).
Fort Stockton, TX	Ban	2011	Ordinance No. 10-117 states that businesses are prohibited from providing plastic shopping bags, which include compostable plastic bags. Instead, businesses may only provide recyclable plastic bags, reusable bags or biodegradable bags as well as recyclable paper bags (Bag Laws, 2017).
Kermit, TX	Ban & Levy	2013	Plastic bags less than 57 microns thick have been banned in stores throughout city limits. Retailers may provide reusable bags as well as recyclable paper bag but must charge at least 0.10USD for the paper bags (Bag Laws, 2017).
Laguna Vista, TX	Ban	2013	Ordinance No. 2012-23 states that businesses are prohibited from providing plastic carry-out bags to their customers. Instead, businesses may provide reusable bags, compostable bags and recyclable paper bags. Affected retail establishments are strongly encouraged to provide incentives for the use of reusable bags through the use of education and credits, rebates, or tokens for individuals who bring reusable bags (Bag Laws, 2017).
Port Aransas, TX	Ban (Failed)	2016	In January 2016, plastic shopping bags were banned in Port Aransas. Nine months later, the city council voted to suspend the ban due to other Texas cities being caught in lawsuits over intended bans, such as Laredo. The city feared that a lawsuit was also on its way (Caffrey, J., 2016).
Sunset Valley, TX	Ban	2013	Plastic bags less than 100 microns thick were banned in September 2015. Retail establishments may provide recyclable paper bags or reusable bags to their customers. Business establishment within the City limits must provide prominently displayed signage advising customers of the benefit of reducing, reusing and recycling and of the need to use reusable carryout bags. (Bag Laws, 2017).
Park City, UT	Ban	2017	It is unlawful for any large grocery to distribute plastic bags less than 57 microns thick to customers. Recyclable paper bags or reusable bags should be made available to customers (Bag Laws, 2017).

Bainbridge Island, WA	Ban & Levy	2012	Bainbridge Island's plastic bag ban went into effect in November 2012. Single-use plastic bags are prohibited. This includes all plastic bags less than 57 microns thick provided at checkout or point of sale. Retailers may provide reusable bags or recycled paper bags but must charge at least 0.05USD for these latter items (Bag Laws, 2017).
Bellingham, WA	Ban & Levy	2012	Plastic bags less than 100 microns thick were banned in retail establishments within city limits in August 2012. Retailers may provide reusable bags or recyclable paper bag. However, they must charge at least 0.05USD per paper bag provided to a customer (Bag Laws, 2017).
Edmonds, WA	Ban	2010	Edmonds was the first town in Washington to ban single-use plastic shopping bags. In fact, since July 2010, retail establishments are only allowed to provide reusable bags and/or recyclable paper bags to their customers. Plastic bags thicker than 57 microns are considered reusable bags (Bag Laws, 2017).
Ellensburg, WA	Levy	2018	An ordinance that requires retailers to charge a minimum fee of 0.05USD for plastic or recyclable paper bags was approved in November 2016. This includes a minimum fee for plastic bags less than 57 microns thick. Thicker plastic bags are considered reusable. The ordinance is set to take effect in January 2018.
Issaquah, WA	Ban & Levy	2013	In 2012, the Issaquah City Council adopted an ordinance that bans single-use plastic carryout bags in retail stores. These are plastic bags less than 57 microns thick. The ban followed a phased approach, applying to larger retailers in March 2013 and smaller retailers as of July 2014. The ordinance also requires stores to charge at least 0.05USD to large recycled paper bags and encourages the use of reusable bags (Bag Laws, 2017).
Kirkland, WA	Ban & Levy	2016	Disposable plastic carryout bags have been banned since March 2016. These include any carryout bag made from plastic or bioplastic, including materials marketed or labeled "biodegradable" or "compostable" that are not reusable. Paper bags may be provided to customers, however, a minimum 0.05USD fee must be applied to larger recyclable paper bags. The use of reusable bags is highly encouraged (Bag Laws, 2017).

Lacey, WA	Ban & Levy	2014	A ban on plastic bags less than 57 microns took effect in July 2017. Retailers may provide any size recyclable paper or reusable carryout bags. However, a minimum fee of 0.05USD must be applied to larger recyclable paper bags. Plastic bags thicker than 57 microns are considered reusable (Bag Laws, 2017)
Mukiltteo, WA	Ban & Levy	2013	Retail establishments within city limits may only provide reusable bags, recyclable paper bags, 100% postindustrial resin bags and/or bags made from renewable compostable materials. Plastic bags with a wall thickness superior to 57 microns are considered reusable, therefore any plastic bag with a thinner wall thickness are prohibited. A mandatory 0.05USD fee must also be applied to all recyclable paper bag provided to customers (Bag Laws, 2017).
Olympia, WA	Ban & Levy	2014	A ban on plastic bags less than 57 microns took effect in July 2017. Retailers may provide any size recyclable paper or reusable carryout bags. However, a minimum fee of 0.05USD must be applied to larger recyclable paper bags. Plastic bags thicker than 57 microns are considered reusable (Bag Laws, 2017)
Port Townsend, WA	Ban & Levy	2012	Plastic bags less than 57 microns thick may not be provided in retail establishments. Retailers may distribute reusable bags and/or recyclable paper bags. A minimum fee of 0.05USD must be applied to larger single use paper bags provided to customers (Bag Laws, 2017).
Quil Ceda Village, WA	Ban	2018	No retail establishment may provide plastic bags less than 100 microns thick to their customers. Thicker plastic bags are considered reusable and may be distributed. Recyclable paper bags and other reusable alternatives may also be distributed to customers (Bag Laws, 2017).
San Juan County, WA	Ban	2017	No retail establishment may provide plastic bags less than 57 microns thick to their customers. Thicker plastic bags are considered reusable and may be distributed. Recycled paper bags and other reusable alternatives may also be distributed to customers (Bag Laws, 2017).
Seattle, WA	Ban & Levy	2012	Since July 2012, retail stores re prohibited from providing customers with plastic bags less than 57 microns thick, which include biodegradable,

				degradable, decomposable, or similar bags. Recyclable paper bags may be provided, however, a minimum fee of 0.05USD must be applied to larger paper bags. Reusable plastic bags thicker than 57 microns are permitted as well as other types of reusable bags, which are highly encouraged. In 2017, the plastic bag prohibition extended to plastic bags (such as produce bags) that are tinted green or brown (Bag Laws, 2017).
	Shoreline, WA	Ban & Levy	2014	Plastic bags less than 57 microns thick were banned from retail establishments in February 2014. Recyclable paper bags are allowed, however, a 0.05USD minimum fee is applied for each paper bag provided to a customer. The use of reusable bags is encouraged (Bag Laws, 2017).
	Tacoma, WA	Ban & Levy	2017	Thin plastic checkout bags may no longer be distributed at any Tacoma retail establishments. These include plastic bags less than 57 microns thick. A minimum pass-through charge of 0.05USD for each recycled paper or reusable checkout bag requested by customers is also required by the ordinance (Bag Laws, 2017).
	Thurston County - Unincorporated, WA	Ban & Levy	2014	A ban on plastic bags less than 57 microns took effect in July 2017. Retailers may provide any size recyclable paper or reusable carryout bags. However, a minimum fee of 0.05USD must be applied to larger recyclable paper bags. Plastic bags thicker than 57 microns are considered reusable (Bag Laws, 2017)
	Tumwater, WA	Ban & Levy	2014	A ban on plastic bags less than 57 microns took effect in July 2017. Retailers may provide any size recyclable paper or reusable carryout bags. However, a minimum fee of 0.05USD must be applied to larger recyclable paper bags. Plastic bags thicker than 57 microns are considered reusable (Bag Laws, 2017)
Australia				
Australia	Birregurra (Victoria)	Voluntary	2004	In October 2004, the 15 businesses in the small town of Birregurra signed declarations that they will no longer distribute plastic bags. Instead, they will be providing paper bags or boxes. Customers will also be given the choice to buy reusable bags, such as bags made of calico (Marino, M., 2004).

Cannons Creek (Victoria)	Voluntary	Early 2000s	Through voluntary agreements between governments and businesses, these towns became plastic bag free (Clean Up Australia, 2015).
Cohuna (Victoria)			
Leitchville (Victoria)			
Metung (Victoria)			
Murtoa (Victoria)			
Timboon (Victoria)			
Coles Bay (Tasmania)	Voluntary	2003	Coles Bay was the first town to become plastic bag free in Australia. The voluntary ban was implemented when the town's businesses agreed to stop distributing plastic bags due to their negative impacts on wildlife and nature. Every household was given calico bags to encourage their use (Fisckling, D., 2003).
Huskisson (NSW)	Voluntary	Early 2000s	Through voluntary agreements between governments and businesses, these towns became plastic bag free (Clean Up Australia, 2015).
Kangaroo Valley (NSW)			
Mogo (NSW)			
Orient Point (NSW)			
Lajamanu (Northern Territory)	Ban	N/A	Lajamanu banned plastic bags throughout its community (Clean Up Australia, 2015).
Milikapiti (Northern Territory)	Ban	2004	Due to environmental and infrastructure damages, the community of Milikapiti banned the use of plastic bags. Instead, paper bags and reusable calico bags are distributed to customers (Tiwi News, 2004).
Oyster Bay (NSW)	Voluntary	2004	In May 2004, the Sydney Community of Oyster Bay became plastic bag free. All local retailers replaced their plastic bags with paper bags instead and 500 reusable calico bags were distributed to residents (Sydney Morning Herald, 2004).
Wadeye (Northern Territory)	Ban	N/A	The cities of Wadeye and Yulara have also banned plastic bags throughout their communities (Clean Up Australia, 2015).

South America				
Argentina	Buenos Aires	Ban	2017	The autonomous city of Buenos Aires banned the use and distribution of non-biodegradable plastic bags in supermarkets, hypermarkets as well as food and beverage self-service stores as of January 1 st , 2017. These stores may now provide eco-friendly bags (biodegradable, reusable, recyclable, etc.), paper bags made of 80% recycled material and plastic bags used for hygiene purposes. Reusable bags must be made with recyclable materials that allow for repeated use and must be a size that would be equivalent to three or four plastic bags (Gobierno de la Ciudad Autonoma de Buenos Aires, 2016).
	El Bolson (Rio Negro)	Ban	2006	On January 1 st , 2006, an ordinance came into effect which prohibits the use of plastic bags in supermarkets, hypermarkets as well as other types of commercial establishments. Biodegradable and reusable bags may still be provided to customers (Agencia de Noticias Bariloche, 2009).
	El Calafate (Patagonia)	Ban	2007	Ordinance No. 1018/06, which came into effect in 2007, prohibits the use of non-biodegradable plastic bags in supermarkets and any other type of commercial establishments throughout the city (Honorable Concejo Deliberante de la Ciudad de El Calafate, 2006).
	San Carlos de Bariloche (Rio Negro)	Ban	2012	Plastic bags were gradually phased-out of supermarkets in late 2012. In August, supermarkets were only allowed to distribute four plastic bags per customer. This amount decreased by one every month until they were completely banned in December. Supermarkets will then provide locally manufactured reusable bags to their customers (Editorial Rio Negro, 2012).
	Ushuaia (Tierra del Fuego)	Ban	2012	Ordinance No. 4040 of 2011 prohibits the use of all plastic bags including biodegradable and oxobiodegradable alternatives in all commercial establishments throughout the city (Concejo Deliberante de la Ciudad de Ushuaia, 2011).
Colombia	Bogota	Reduction campaign	2011	In May 2011, a program to reduce the environmental impacts caused by lightweight plastic shopping bags was introduced in Bogota. This program, led by the District Department of the Environment seeks to reduce by at least 40% the number of plastic bags used in supermarkets, chain stores and

				shopping centers through campaigns aimed at rationalization, reuse and recycling (Secretaria Distrital de Ambiente, 2011).
Ecuador	Loja	Ban	2017	In March 2017, an ordinance was published which regulated the implementation of sustainable practices to reduce harmful environmental impacts. Through this ordinance, the use of plastic bags is regulated by gradually reducing their use at first and then completely banning them in August 2017. Only reusable bags will be allowed as of August 2017 (Diaz, Y., 2017).
Peru	La Molina	Reduction campaign	2016	In October 2016, an ordinance that promote the reduction of products made from single-use plastic materials, including plastic bags. The ordinance establishes a framework to promote good environmental practices in the district. Each Wednesday was declared a “Day Without Plastic”; environmental education campaigns are carried out to raise awareness and promote reusable and/or biodegradable alternatives; and a “Environmentally friendly establishment” certification was established to recognize commercial establishment which voluntarily implement strategies to reduce their use and distribution of plastic bags (Bianchi-Diminich, C.I., 2016).

References

- Abada, A. (2016) Ethiopia to restrict the use of plastic products. Africa Review. Published March 29th, 2016. [Online] <http://www.africareview.com/news/Ethiopia-to-restrict-the-use-of-plastic-products/979180-3137822-jumv3o/index.html>
- A Bag's Life (2010-A) Statewide plastic bag recycling campaign launches during earth day at the Capitol. Posted April 21st, 2010. [Online] <http://www.abagslife.com/blog/blog.php?id=7459>
- A Bag's Life (2010-B) Virginia launches campaign aimed at plastic bag recycling. Posted November 17th, 2010 [Online] <http://www.abagslife.com/blog/blog.php?id=12965>
- A Bag's Life (2011-A) A Bag's Life Kicks off in New York. Posted December 31st, 2011. [Online] <http://www.abagslife.com/blog/blog.php?id=18618>
- A Bag's Life (2011-B) North Carolina launches A Bag's Life plastic bags recycling program. Posted March 11th, 2011 [Online] <http://www.abagslife.com/blog/blog.php?id=14374>
- A Bag's Life (2011-C) Keep Pennsylvania Beautiful. Posted December 2nd, 2011. [Online] <http://www.abagslife.com/blog/blog.php?id=18615>
- A Bag's Life (2011-D) A Bag's Life launches at the Texas State Capitol. Posted February 15th, 2011. [Online] <http://www.abagslife.com/blog/blog.php?id=14304>
- A Bag's Life (2012) Statewide plastic bag recycling program launches at Georgia Capitol. Posted March 2nd, 2012 [Online] <http://www.abagslife.com/blog/blog.php?id=18620>
- A Bag's Life (2017) Louisiana [Online] <http://www.abagslife.com/louisiana/>
- Abdullah, A. (2015) Ajman becomes 90 percent plastic bag free. Khaleej Times. Published, May 25th, 2015 [Online] <https://www.khaleejtimes.com/nation/general/ajman-becomes-90-per-cent-plastic-bag-free>
- Actualicese (2017) Impuesto al uso de bolsas plasticas, modificacion al INC por un ambiente sano. Published May 12th, 2017. [Online] <http://actualicese.com/actualidad/2017/05/12/impuesto-al-uso-de-bolsas-plasticas-modificacion-al-inc-por-un-ambiente-sano/>
- AEON (2015) Shopping bag campaign. [Online] <http://www.aeon.info/environment/environment/mybag.html>

- Agence Telegraphique Suisse (2016) Le Parlement renounce a demander une interdiction. Parlement Suisse. Published September 22nd, 2016. [Online Press Release] https://www.parlament.ch/fr/services/news/Pages/20160922121207274194158159041_bsf092.aspx
- Agencia de Noticias Bariloche (2009) Insisten con la prohibicion de utilizar bolsas de plastico en los comercios. Published February 28th, 2009 [Online] <http://www.anbariloche.com.ar/noticias/2009/02/28/7524-insisten-con-la-prohibicion-de-utilizar-bolsas-de-plastico-en-los-comercios>
- Agencia de residus de Catalunya (2017) Prohibicion de la gratuidad de las bolsas de plastico. Generalitat de Catalunya. Last updated March 29th, 2017 [Online] http://residus.gencat.cat/es/ambits_dactuacio/prevencio/prohibicio-per-la-gratuitat-de-les-bosses-de-plastic/
- Agriculture and Agri-Food Canada (2016) An Overview of the Canadian Agriculture and Agri-Food System 2016. Last updated May 9th 2016. [Online] <http://www.agr.gc.ca/eng/an-overview-of-the-canadian-agriculture-and-agri-food-system-2016/?id=1462288050282#a3>
- Akita Prefectural Government Office (2017) Regarding the efforts of business entities that conclude an agreement on shopping bag reduction/my bag promotion campaign. Published January 31st, 2017 [Online] <http://www.pref.akita.lg.jp/pages/archive/7542>
- Alam, H. (2010) Poly bags rule despite ban. The Daily Star. Published September 19th, 2010. [Online] <http://www.thedailystar.net/news-detail-155049>
- Alami, A. (2016) Going green: Morocco bans use of plastic bags. AlJazeera, Morocco. Published July 1st, 2016. [Online] <http://www.aljazeera.com/news/2016/07/green-morocco-bans-plastic-bags-160701141919913.html>
- Alberta Environment and Parks (2012) Alberta Plastic Bag Distribution. Annual Report March 2012. Retrieved from <http://aep.alberta.ca/waste/waste-and-recycling-at-home/documents/PlasticBagReduction-2012AnnualReport-2016.pdf>
- Ali, C. (2016) Plus de sacs plastiques à partir du 1^{er} juillet. FranceInfo : Mayotte 1ere. Published June 10th, 2016. [Online] <http://la1ere.francetvinfo.fr/mayotte/plus-de-sacs-plastiques-partir-du-1er-juillet-369515.html>
- All About Bags (2012) Reduction Strategies – What Works? [Online] <http://www.allaboutbags.ca/reduction.html#top>
- aLome News (2014) Sachets plastiques: les contrevenants doivent se conformer sous peine de sanctions. Published August 27th, 2014 [Online] <http://news.alome.com/h/26208.html>
- Al Serkal, M. (2013) Dubai municipality drive to cut use of 500m plastic bags by year-end. Gulf News: Environment, Published May 9th, 2013 [Online] <http://gulfnews.com/>

news/uae/environment/dubai-municipality-drive-to-cut-use-of-500m-plastic-bags-by-year-end-1.1181428

Alvarez, P. & Weidenslaufer, C. (2014) Restricciones o prohibiciones en el uso de bolsas plasticas: Legislacion comprada. Biblioteca del Congreso Nacional de Chile. Asesoría Técnica Parlamentaria, November 11th, 2014

Amanpoor, A.S. (2014) Despite ban, plastic bags continue to jeopardize health of people in Afghanistan. Afghan Zariza. Pulished December 4th, 2014. [Online] <http://www.afghanzariza.com/2014/12/04/despite-ban-plastic-bags-continue-to-jeopardize-health-of-people-in-afghanistan>

American Samoa Environmental Protection Agency (2017) Plastic Bag Ban. [Online] <http://www.epa.as.gov/plastic-bag-ban>

Ampnsem, J. (2017) Ghana: Active citizen discussion “Ban on Plastics”. Africa Business. Published January 13th, 2017. [Online] <http://africabusiness.com/2017/01/13/ghana-active-citizen-discuss-ban-on-plastics/>

Andreou, E. (2017) Plastic bag levy from next year (Updated). Cyprus Mail. Published July 13th, 2017. [Online] <http://cyprus-mail.com/2017/07/13/134580/>

Anacostia River Cleanup and Protection Act of 2009. D.C. Law 18-55, § 4, 56 DCR 5703

Anwar, S. (2015) Non-degradable products; Plastic bags posing environmental hazards. The Express Tribune Pakistan, Published January 27th, 2015 [Online] <https://tribune.com.pk/story/828090/non-degradable-products-plastic-bags-posing-environmental-hazards/>

Aomori Prefectural Government (2017) About efforts to reduce plastic shopping bags. Last updated June 27th, 2017 [Online] <http://www.pref.aomori.lg.jp/nature/kankyo/rejibukuro.html>

Arabian Business (2016) UAE should implement ban on plastic bags, says FNC. Published March 30th, 2016. [Online] <http://www.arabianbusiness.com/uae-should-implement-ban-on-plastic-bags-says-fnc-626690.html>

Arkansas State Legislature (2013) House Bill 1036 – Introduced by Representative Altes. State of Arkansas: 89th General Assemble, Regular Session, 2013. January 17th, 2013 [Online] <http://www.arkleg.state.ar.us/assembly/2013/2013R/Pages/BillInformation.aspx?measureno=HB1036>

Asmuni, Hussin, Khalili & Zain (2015) Public participation and effectiveness of the no plastic bag day program in Malaysia. Procedia-Social and Behavioral Sciences, Volume 168, p.328-340. Published January 9th, 2015.

- Association des détaillants en alimentation du Québec, Canadian Council of Grocery Distributors, Conseil Québécois du commerce de détail, Éco Entreprise Québec & RecycQuébec (2008) Voluntary code of best practices for the use of shopping bags. April 2008 [Online] <http://www.cqcd.org/static/en-CA/pdf/voluntary-code-of-best-practices-shopping-bags.pdf>
- Australian Capital Territory government (2017) Plastic bag ban. Environment, Planning and Sustainable Development Directorate – Environment. Last updated June 7th, 2017 [Online] <https://www.environment.act.gov.au/waste/plastic-bag-ban>
- Baaitse, F. (2015) Gov't failing to collect plastic levy. Botswana Weekend Post. Published May 25th, 2015. [Online] <http://www.weekendpost.co.bw/wp-news-details.php?nid=1053>
- Bag Laws (2017) Bag Laws: The resource for retail packaging legislation [Online] <http://www.baglaws.com/>
- Bag Laws (2016) Bag ban in Puerto Rico going into effect. Posted October 5th, 2016 [Online] <http://www.baglaws.com/news/bag-ban-in-puerto-rico-going-into-effect/>
- Bah, S. (2015) Vendors, consumers seek for substitute to banned plastic bags. Foroyaa Newspaper. Published April 27th, 2015. [Online] <http://www.foroyaa.gm/archives/4919>
- Balch, O. (2014) EU legislation on plastic bag pricing must be accompanied by retailer action. The Guardian. Published April 29th, 2014. [Online] <https://www.theguardian.com/sustainable-business/plastic-bag-eu-law-tax-charge-retailers-sustainable>
- Barbiere, C. (2015) EU to halve plastic bag use by 2019. Translated by White, S. (2015) EurActive French Reports. Published April 29th 2015. [Online] <https://www.euractiv.com/section/sustainable-dev/news/eu-to-halve-plastic-bag-use-by-2019/>
- Bayo Jr., I. (2017) Plus aucun sachet plastique en circulation au Niger. La Tribune Afrique. Published August 18th, 2017 [Online] <http://afrique.latribune.fr/entreprises/industrie/energie-environnement/2017-08-18/plus-aucun-sachet-plastique-en-circulation-au-niger-747320.html>
- BBC News (2007) East African ban on plastic bags. Published June 14th, 2007. [Online] <http://news.bbc.co.uk/1/hi/world/africa/6754127.stm>
- Bethel Municipal Code (2017) Chapter 8.12: Plastic Bags and Polystyrene Containers. Current through Ordinance 17-43, September 26th, 2017 [Online] <http://www.codepublishing.com/AK/Bethel/>
- Bianchi-Diminich, C.I. (2016) Ordenza No. 324: Ordenza que promueve la reduccion de luso de elementos elaborados a base de plastico y de un solo uso en el distrito de La

- Molina. El Peruano, Published October 7th, 2016 [Online] <http://busquedas.elperuano.pe/normaslegales/ordenanza-que-promueve-la-reduccion-del-uso-de-elementos-ela-ordenanza-no-324-1439202-1/>
- Bienvenu Wanga et al. (2014) comparative study of legal instruments of Democratic Republic of Congo, Cameroon, and Congo Republic into the production of non-biodegradable package. International Journal of Innovation and Applied Studies. Vol. 9 No. 4. December 4th, 201. pp. 1755-1764
- Bisbee City Council (2017) Ordinance 0-17-15. November 21st, 2017 [Online] <https://www.bisbeeaz.gov/documentcenter/view/4002>
- Block, B. (2016) China reports 66-percent drop in plastic bag use. World Watch Institute. [Online] <http://www.worldwatch.org/node/6167>
- Brasor, P. & Tsubuku, M. (2013) Supermarkets finally get serious about shopping bags. The Japan Times. Published November 21st, 2013. [Online] <http://blog.japantimes.co.jp/yen-for-living/supermarkets-finally-get-serious-about-shopping-bags/>
- Breniuc, I. (2015) Whi in Romania the eco-t did not reduce the consumption of plastic bags, as in other EU states. Green Report Romania. Published October 21st, 2015. [Online] <https://www.green-report.ro/de-ce-in-romania-eco-taxa-nu-a-reduc-consumul-de-pungi-de-plastic-ca-in-alte-state-ue/>
- Briet, S. (2004) La Corse, modèle antiplastique. Libération, published October 25th, 2004 [Online] http://www.liberation.fr/terre/2004/10/25/la-corse-modele-antiplastique_497178
- Bruxelles Environnement (2017) Les sacs à usage unique. Last updated October 31st, 2017 [Online] <http://www.environnement.brussels/thematiques/dechets-ressources/vos-obligations/les-sacs-usage-unique>
- Bruxelles Environnement (2018) Interdiction des sacs de caisse à usage unique : Bruxelles Environnement mène des actions de contrôle sur le terrain. Published January 2nd, 2018 [Online] <http://www.environnement.brussels/news/interdiction-des-sacs-de-caisse-usage-unique-bruxelles-environnement-mene-des-actions-de>
- Bonarrigo, S. (2017) La fin des sac plastiques. Monaco Hebdo. Published January 13th, 2017. [Online] <http://www.monacohebdo.mc/19668-fin-sacs-plastiques>
- Botswana Bureau of Standards (2017) Standards Catalogue: April 2017. page 77
- Boulder City (2017) What is the disposable bag fee. [Online] <https://bouldercolorado.gov/zero-waste/disposable-bag-fee>
- Boulder Daily Camera (2016) Boulder ponders raising grocery bag fee to reduce use. The Denver Post. Published September 28th, 2016 [Online] <https://www.denverpost.com/2016/09/28/boulder-raising-grocery-bag-fee/>

- Brenuic, I. (2015) Why the eco-tax in Romania has not reduced the consumption of plastic bags, as in other EU states. Green Report. Published October 21st, 2015 [Online] <https://www.green-report.ro/de-ce-in-romania-eco-taxa-nu-a-reduc-consumul-de-pungi-de-plastic-ca-in-alte-state-ue/>
- Budhwari, Y. (2017) Uttarakhand government imposes plastic ban. The Times of India. Published January 15th, 2017 [Online] <https://timesofindia.indiatimes.com/city/dehradun/uttarakhand-government-imposes-plastic-ban/articleshow/56541475.cms>
- Burkina Faso National Assembly (2014) Loi No^o. 017-2014/AN: Portant interdiction de la production, de l'importation, de la commercialisation et de la distribution des emballages et sachets plastiques non-biodégradable. IV^e République, Cinquième Législateur. Unité-Progrès-Justice. May 20th, 2014.
- Business Focus (2017) Uganda lags behind as Kenya implements ban on plastic bags. Published August 28th, 2017. [Online] <http://businessfocus.co.ug/uganda-lags-behind-kenya-implements-ban-plastic-bags/>
- Business Focus Antigua (2016) Plastic bag ban implemented as gov't launches reusable bag initiative. Published September 22nd, 2016. [Online] <http://businessfocusantigua.com/13042/>
- Butlleti Oficial del Principat d'Andorra (2017) Decret del 17-05-2017 d'aprovacio del Reglament per a la reduccio del consum de les bosses de plastic. Andorra la Vella, May 17th, 2017. [Online] https://www.bopa.ad/bopa/029033/Documents/GR20170518_15_03_01.pdf
- BYO Bag (2017, June 28) Phil Goff speaks about need for plastic bag regulation. [Online Press Release] <http://www.scoop.co.nz/stories/PO1706/S00392/phil-goff-speaks-about-need-for-plastic-bag-regulation.htm>
- Cabo Verde Council of Ministers (2015) Aprova a interdição da produção, da importação e da comercialização de sacos de plástico convencional para a embalagem. Republica de Cabo Verde. Approved March 26th, 2015. [Online] http://www.parlamento.cv/userfiles/image/HIPERLINK/Sacos%20de%20pl%C3%A1stico_Ante-Proposta%20de%20Lei%2009012015-%20ultima%20vers%C3%A3o.pdf
- Caffrey, J. (2016) Port Aransas suspends plastic bag ban. September 16th, 2016 [Online] <http://www.kristv.com/story/33115196/port-aransas-suspends-plastic-bag-ban>
- California Legislative Information (2014) Senate Bill No. 270: Chapter 850. Solid waste: single-use carryout bags. Approved by Governor September 30th, 2014 [Online] https://leginfo.legislature.ca.gov/faces/billNavClient.xhtml?bill_id=201320140SB270
- Californians Against Waste (2015) Plastic bags: Local ordinances. [Online] <https://www.cawrecycles.org/list-of-local-bag-bans/>

- CalRecycle (2017) Plastic Carryout Bags: Ban on single-use carryout bags (SB 270/Proposition 67) – Frequently asked questions. California Department of Resources Recycling and Recovery. Last Updated May 4th, 2017. [Online] http://www.calrecycle.ca.gov/Plastics/CarryOutBags/FAQ.htm#Ordinanceshttp://leginfo.legislature.ca.gov/faces/codes_displayexpandedbranch.xhtml?tocCode=PRC&division=30.&title=&part=3.&chapter=5.3.&article
- Canada Department of Justice (2015) Federal legislation and the private law of the Canadian territories: An argument for Complementarity. Last modified July 9th, 2015. [Online] <http://www.justice.gc.ca/eng/rp-pr/csj-sjc/harmonization/gaudr/territories/p1.html>
- Canadian Plastics (2011) Northwest Territories imposes plastic bag tax. Published February 16th 2011 [Online] <http://www.canplastics.com/packaging/northwest-territories-imposes-plastic-bag-tax/1000402460/>
- Canadian Plastics Industry (2012) Canada Update – Trends in Managing Plastic Shopping Bags. Published online at All About Bags. <http://www.allaboutbags.ca/canadaupdate.html#1>
- Card, D. (2016) Packaging taxes in Belgium. Institute for European Environmental Policy and Eunomia. December 2016 [Online] <https://ieep.eu/uploads/articles/attachments/750b4c86-75d6-4016-8e1b-da2e69d2ded9/BE%20Packaging%20Tax%20conference%20draft.pdf?v=63673818840>
- Carvalho, J.D. (2016) Why Aruba just banned plastic bags. CJ Caribbean Journal. [Online] <https://www.caribjournal.com/2016/08/08/aruba-just-banned-plastic-bags/#>
- CBC News (2007) It's official: Manitoba town gives plastic bags the boot. Published April 2nd, 2007 [Online] <http://www.cbc.ca/news/canada/manitoba/it-s-official-manitoba-town-gives-plastic-bags-the-boot-1.657651>
- CBC News (2016) Montreal to ban plastic shopping bags as of 2018. Published February 22nd 2016 [Online] <http://www.cbc.ca/news/canada/montreal/denis-coderre-plastic-bag-ban-future-montreal-1.3458240>
- Central Intelligence Agency (2017) Welcome to the World Factbook. [Online] <https://www.cia.gov/library/publications/resources/the-world-factbook/index.html>
- Center for Environment and Development for the Arab Regions and Europe (2017) Egyptian Minister of Environment launches the “National Initiative of Reduction of Plastic Bags Consumption”. Resource Efficiency & Green Economy. [Online] <http://web.cedare.org/sgp/events/2017/06/06/egyptian-minister-of-environment-launches-the-national-initiative-of-reduction-of-plastic-bags-consumption/#more-2756>
- Chaffee, C. and Yaros, BR. (2007) Life Cycle Assessment for Three Types of Grocery Bags – Recyclable Plastic; Compostable, Biodegradable Plastic; and Recycled,

Recyclable Paper. Final report prepared for the Progressive Bag Alliance. [Online] <https://plastics.americanchemistry.com/Life-Cycle-Assessment-for-Three-Types-of-Grocery-Bags.pdf>

Chamorro, P.J. (2017) Necesaria ley como la 492 de Panama. La Prensa. Published August 23rd, 2017. [Online] <http://www.laprensa.com.ni/2017/08/23/columna-del-dia/2284287-necesaria-ley-como-la-492-de-panama>

China Ministry of Commerce (2008) Administrative measures for the paid use of plastic bags at commodity retailing places. Order No.8 [2008] of the ministry of Commerce, the National Development and Reform Commission and the State Administration for Industry and Commerce. [Online] <http://www.lawinfochina.com/display.aspx?lib=law&id=6822&CGid=>

Chitotombe, J.W. (2014) The Plastic bag ban controversy in Zimbabwe: an analysis of policy issues and local responses. *International Journal of Development and Sustainability*. Volume 3, Number 5, pp. 1000-1012

Chong et al. (2010) Information Campaign to Reduce Plastic Bag Consumption in Supermarkets in Mexico. *Innovations for Poverty Action (IPA)*. [Online] <https://www.povertyactionlab.org/evaluation/information-campaign-reduce-plastic-bag-consumption-supermarkets-mexico>

Chuan, K. & Chen, C. (2017) Taiwan to expand ban on free plastic bags next year. *Focus Taiwan News Channel*. Published July 20th, 2017. [Online] <http://focustaiwan.tw/news/afav/201707200016.aspx>

City Council of Desert Hot Springs (2017) Ordinance No. 543: Single-Use Carryout Plastic Bags. Adopted March 18th, 2014 [Online] <http://www.qcode.us/codes/deserthotsprings/revisions/543.pdf>

City of Brossard (2016) By-law No. REG-351: By-law relating to the distribution of shopping bags. [Online] http://www.ville.brossard.qc.ca/Brossard/media/Documentation/Environnement/REG-351_By-LAW_translation_Plastic_Shopping_Bags.pdf

City of Montreal (2016) By-law 16-051: By-law prohibiting the distribution of certain shopping bags in retail stores. Published April 30th, 2016 [Online] <http://ville.montreal.qc.ca/sel/sypre-consultation/afficherpdf?idDoc=27530&typeDoc=1>

City of Montreal (2018) Light plastic bags prohibited as of January. Published January 10th, 2018. [Online] <https://beta.montreal.ca/en/nouvelles/light-plastic-bags-prohibited-january>

City of Santa Barbara (2016) Two-year review of single-use carryout bag ordinance. Environmental Services Division, Finance Department. April 26th, 2016 [Online]

http://services.santabarbaraca.gov/CAP/MG131792/AS131796/AS131810/AS131816/AI135427/DO135428/DO_135428.pdf

City of Thompson (2010) By-law number 1839-2010: Single-use plastic bag by-law. Passed on September 27th, 2010 [Online] <http://www.thompson.ca/modules/showdocument.aspx?documentid=1192>

City of Victoria (2017) Reducing single-use plastic bags. [Online] <http://www.victoria.ca/EN/main/residents/climate-change/single-use-plastic-bags.html>

City of Walnut Creek (2017) Plastic bag ordinance. [Online] <http://www.ci.walnut-creek.ca.us/plastic-bag-regulations>

Clapp, J. & Swanston, L. (2009) Doing away with plastic shopping bags: international patterns of norm emergence and policy implementation. *Environmental Politics*, 18:3. May 2009 pp.315-332

Clean Up Australia (2015) Report on actions to reduce circulation of single-use plastic bags around the world. (2nd ed.) [Online] http://www.cleanup.org.au/PDF/au/cua_plastic_bag_usage_around_world_august-2015.pdf

Comores Infos (2016) L'usage du sac plastique prohibé à Moroni. Published January 12th, 2016 [Online] <http://www.comores-infos.net/lusage-du-sac-plastique-prohibe-a-moroni/>

Congreso de la Republica de Colombia (2015) Proyecto de Ley No.º163 Por medio de la cual se impulsa el uso de bolsas reutilizables y se compromete a toda la cadena de produccion, utilizacion y postconsumo a desmonstrar paulatinamente el uso de bolsas plasticas de unico uso, inutiles y no reutilizables y se dictan ostras disposiciones. [Online] http://www.imprenta.gov.co/gacetap/gaceta.mostrar_documento?p_tipo=22&p_numero=163&p_consec=44408

Congreso de Michoacan de Ocampo (2016) Ley ambiental para el desarrollo sustentable del estado de Michoacan de Ocampo. Ultima reforma publicada en el periodico oficial el 29 diciembre de 2016. [Online] http://transparencia.congresomich.gob.mx/media/documentos/trabajo_legislativo/ley_ambiental_para_el_desarrollo_sustentable_ref_29_dic_2016.pdf

Connecticut Department of Energy & Environmental Protection (2017) CT DEEP, public officials launch campaign to recycle more plastic bags, wraps. Published February 21st, 2017. [Press Release] <http://www.ct.gov/deep/cwp/view.asp?A=4918&Q=590322>

Connecticut General Assembly (2017) An act establishing a tax on single-use plastic and paper bags. Substitute for H.B. No. 6313: Session year 2017. [Online] https://www.cga.ct.gov/asp/cgabillstatus/cgabillstatus.asp?selBillType=Bill&bill_num=HB06313&which_year=2017

- Conseil québécois du commerce de détail (2017) Voluntary good practices code for plastic bag management. [Online] <http://www.cqcd.org/en/tools/voluntary-good-practices-code-for-plastic-bag/>
- Consejería de Hacienda y Administración Pública (2017) Impuesto sobre las bolsas de Plastico de un Solo Uso en Andalucía. Last Updated October 2017 [Online] <http://www.juntadeandalucia.es/economia/hacienda/tributos/impuestos/propios/bolsas.htm>
- Concejo Deliberante de la Ciudad de Ushuaia (2011) Ordenanza No. 4040. Last modified December 6th, 2011 [Online] <http://www.concejoushuaia.com/biblioteca/files/ordenanzas/4040.pdf>
- Conserving Now (2018) Plastic bag consumption facts. [Online] <https://conservingnow.com/plastic-bag-consumption-facts/>
- Cook Islands News (2012) Plastic bag ban still in transition. Published October 9th, 2012. [Online] <http://www.cookislandsnews.com/national/environment/item/15363-plastic-bag-ban-still-in-transition/15363-plastic-bag-ban-still-in-transition><http://www.ciherald.co.ck/articles/t454b.htm>
- Coop (2017) NY lag om plastkassar – det har hor Coop. Published June 1st, 2017. [Online] <http://pressrum.coop.se/ny-lag-om-plastkassar-det-har-gor-coop/>
- Cooper, L. (2017) Victoria just announced it will ban single-use plastic bags. The Huffington Post Australia. Published October 17th, 2017. [Online] http://www.huffingtonpost.com.au/2017/10/17/victoria-just-announced-it-will-ban-single-use-plastic-bags_a_23245619/
- Cordova Municipal Council (2017) Chapter 8.37: Plastic Bags and Polystyrene Containers. Current through Ordinance No. 1160, November 1st, 2017. [Online] https://library.municode.com/ak/cordova/codes/code_of_ordinances?nodeId=TIT8HE_SA_CH8.37PLBAPOCO
- Corporal, L.L. (2010) Thailand fights addiction to plastic bags. The Guardian: Environment Network, Published June 28th, 2010 [Online] <https://www.theguardian.com/environment/2010/jun/28/thailand-plastic-bags>
- Corriveau, J. (2017) La fin des sacs de plastique à Montréal en 2018. Le Devoir. Published December 8th, 2017 [Online] <http://www.ledevoir.com/politique/montreal/514994/la-fin-des-sacs-de-plastique>
- Corroenne, O. (2017) En Wallonie, les sacs plastiques n'ont pas (encore) disparu. Radio-télévision belge de la Fédération Wallonie-Bruxelles, Published June 13th, 2017 [Online] https://www.rtf.be/info/societe/onpdp/enquetes/detail_en-wallonie-les-sacs-plastiques-n-ont-pas-encore-disparu?id=9631773

- Coulibaly, M. (2017) Lutte contre les sachets plastiques au Mali: Le tendon d'Achille du government. Published February 14th, 2017. [Online] <http://news.abamako.com/h/152687.html>
- Countdown (2017) Plastic bags. [Online] <https://www.countdown.co.nz/community-environment/environmental-sustainability/our-commitment-to-phasing-out-plastic-bags>
- County of Los Angeles (2016) About the bag: Announcements. Department of Public Works [Online] <http://dpw.lacounty.gov/epd/aboutthebag/announcements.cfm>
- Cunninghame, M. (2017) This South Pacific nation is saying goodbye to single-use plastic bags and bottles. Nation of Change, published August 4th, 2017. [Online] <https://www.nationofchange.org/2017/08/04/south-pacific-nation-saying-goodbye-single-use-plastic-bags-bottles/>
- Cusi, R.C. (2012) Proyecto de ley – Promueve el uso sostenible de bolsas biodegradables a nivel nacional. Proyecto de Ley No.º1638/2012-CR. Congreso de la Republica del Peru. Lima, Peru. Published October 30th, 2012
- The Danish Ecological Council (2015) Consequences of the European plastic bag Directive. Published August 6th, 2016. [Online] <https://www.ecocouncil.dk/en/releases-3/109-economy-and-politics/2568-consequences-of-the-european-plastic-bag-directive>
- Dar Post (2017) Manufacturers hope for middle-ground on bag ban. Published July 23rd, 2017. [Online] <http://www.darpost.com/2017/07/manufacturers-hope-for-middle-ground-on-bag-ban/>
- DC Department of Energy & Environment (2015) Skip the Bag, Save the River. [Online] <https://doee.dc.gov/bags>
- Delaware (2015) Chapter 198, Formerly House Bill No. 15. As amended by House Amendment No. 1. An Act to Amend Chapter 60, Title 7 of the Delaware Code Relating to Recycling and Waste Reduction in the State of Delaware. 7 DE Code § 6099A (2015)
- Delaware General Assembly (2009) House Bill 15. 145th General Assemle (2009-2010). Signed August 17th, 2009. [Online] <https://legis.delaware.gov/BillDetail/19538>
- Dempsy, N. (2001) S.I. No. 605/2001 – Waste Management (Environmental Levy) (Plastic Bag) Regulations, 2001. Minister of Environment and Local Government. Published December 19th, 2001. [Online] <http://www.irishstatutebook.ie/eli/2001/si/605/made/en/print>
- Departamento de Asuntos del Consumidor (2016) Informacion sobre la ley que prohíbe el uso de bolsas plasticas. Posted October 21st, 2016 [Online] <http://daco.gobierno.pr/educacion/bolsasplasticas>

- Department for Environment, Food & Rural Affairs (2015) Carrier bag charges: retailers' responsibilities. UK Government. Last updated July 31st, 2017. [Online] <https://www.gov.uk/guidance/carrier-bag-charges-retailers-responsibilities>
- Department of Environment, Parks and Recreation (2013) No plastic bag weekend. Brunei Ministry of Development. [Online] <http://www.env.gov.bn/SitePages/No%20Plastic%20Bag%20Weekend.aspx>
- Department of Environmental Affairs and Tourism (2002) Memorandum of Agreement between the Department of Environmental Affairs and Tourism, organised labour, and organised business. September 26th, 2002. [Online] https://www.westerncape.gov.za/text/2005/7/mou_plastic_26092002.pdf
- De Verteuil, M. (2017) Retailers on Caribbean island of Barbados introduce a voluntary plastic bag charge. Cyan Caribbean. Published May 29th, 2017. [Online] <https://www.cyancaribbean.com/single-post/2017/05/28/Retailers-on-Caribbean-island-of-Barbados-introduce-a-voluntary-plastic-bag-charge>
- Diaz, Y. (2017) Ordenza de la huella ambiental en registro oficial. Municipio de Loja. Published March 28th, 2017 [Online] <http://www.loja.gob.ec/noticia/2017-03/ordenanza-de-la-huella-ambiental-en-registro-oficial>
- Dikgang, J. & Visser, M. (2010) Behavioral response to plastic bag legislation in Botswana. Environment for Development: Discussion Paper Series. Published May 25th, 2010. EfD DP 10-13.
- Dikgang, Leiman & Visser (2012) Elasticity of demand, price and time: Lessons from South Africa's plastic-bag levy. Applied Economics, 44:26, pp. 3339-3342
- Dodgley, D. (2017) Environment Protection Act, 2016 – Environment Protection (Restriction on manufacturing, importation and distribution of Plastic Bags) Regulations 2017. S.I. of 2017, Ministry of Environment, Energy & Climate Change. January 10th, 2017. [Online] https://members.wto.org/crnattachments/2017/TBT/SYC/17_0650_00_e.pdf
- Duboise, T. (2012) Albay province, Philippines, prohibits plastic bags. Plastic bag ban report. Posted June 3rd, 2012 [Online] <http://plasticbagbanreport.com/albay-province-philippines-prohibits-plastic-bags/>
- Dupuis, B. (2016) Plastic bag fee helps bring usage down. Pique News Magazine, Published June 11th, 2016 [Online] <https://www.piquenewsmagazine.com/whistler/plastic-bag-fee-helps-bring-usage-down/Content?oid=2794979>
- E.Leclerc (2016) E.Leclerc et la suppression des sacs de sortie de caisse : un combat pour la protection de l'environnement. Dossier de presse, July 2016 [Online] https://www.mouvement.leclerc/sites/default/files/2016-07/DP%20E.LECLERC-160701_0.pdf

- Earth Justice (2015) Philippines: Plastic bag bans to reduce land-based marine pollution. [Online] <https://ocean.si.edu/sites/default/files/Philippines%20Earth%20Justice%20Law%20Summary.pdf>
- Earth Policy Institute (2014) Plastic bag regulations worldwide. Data for Plan B Update 123. Published May 1st, 2014. [Online] http://www.earth-policy.org/data_center/C26
- Editorial Rio Negro (2012) Bariloche comienza a eliminar las bolsas plasticas. Published August 1st, 2012 [Online] http://www.rionegro.com.ar/region/bariloche-comienza-a-eliminar-las-bolsas-plast-HCRN_931745
- Edwards, C. and Fry, JM. (2011) Life cycle assessment of supermarket carrier bags: a review of the bags available in 2006. Published February 2011 by the Environment Agency (UK)
- Eglitis, J. (2016) Latvijā grib mainīt pircēju paradumus: veikalos aizlieds par brīvu dalīt plastmasas maisiņus. Published September 15th, 2016. [Online] <https://skaties.lv/zinas/latvija/latvija-grib-mainit-pirceju-paradumus-veikalos-aizlieds-par-brivu-dalit-plastmasas-maisinus/>
- Ejercito, J.V. (2013) Plastic bag regulation Act of 2013. Senate of the Philippines, 16th Congress. Senate Bill No.1454. Filed August 29th, 2013 [Online] https://www.senate.gov.ph/lis/bill_res.aspx?congress=16&q=SBN-1454
- Ekoulla, C. (2016) Interdiction des emballages plastiques : Pourquoi certains pays echouent? Published June 9th, 2016 [Online] <http://afriqueinside.com/interdiction-emballages-plastiques-certains-pays-echouent09062016/>
- Environmental Protection Department (2015) Environmental levy scheme on plastic shopping bags. The Government of the Hong Kong Special Administrative Region. Last updated May 22nd, 2015[Online] http://www.epd.gov.hk/epd/english/environmentinhk/waste/pro_responsibility/env_levy.html
- Equinox Center (2013) Plastic Bag Bans: Analysis of Economic and Environmental Impacts. Published October 23, 2013. San Diego, CA.
- Estonia State Gazette (2017) Packaging Act 2004. Published April 10th, 2017. [Online] <https://www.riigiteataja.ee/en/eli/510042017001/consolide>
- European Commission (2017) June infringements package : key decisions. Brussels, June 14th, 2017. [Online] http://europa.eu/rapid/press-release_MEMO-17-1577_en.htm
- European Environment Agency (2011) 2011 Survey of resource efficiency policies in EEA member and cooperating countries – Latvia. Published May 2011. [Online] <https://www.eea.europa.eu/themes/economy/resource-efficiency/resource-efficiency-policies-country-profiles>

- European Parliament and the Council of the European Union (2015) EU Directive 2015/720. Official Journal of the European Union, April 29th, 2015
- Fanovich, Gozaine & Aleman (2017) Proyecto de Ley 492 – Que promueve el uso y entrega de bolsas reutilizables en establecimientos comerciales a nivel nacional. Asamblea Nacional Panama. Tramite Legislativo 2016-2017. Published April 17th, 2017. [Online] http://www.asamblea.gob.pa/proyley/2017_P_492.pdf
- Federal Ministry of Agriculture, Forestry, Environment and Water Management (2017) Farewell plastic carrier bag. Ocean Conference, United Nations, New York, June 5-9 2017. [Online] <https://oceanconference.un.org/commitments/?id=16526>
- Fickling, D. (2003) Tasmania carries the eco-fight by banning plastic bags carries hoped of environment. The Guardian, published April 29th 2003 [Online] <https://www.theguardian.com/world/2003/apr/29/australia.davidfickling>
- Fight the Plastic Bag Ban (2013) Citizens of Homer, Alaska Overturn Plastic Bag Ban. October 5th, 2013 [Online] <https://fighttheplasticbagban.com/2013/10/05/citizens-of-homer-alaska-overturn-plastic-bag-ban/>
- Fiji Bill No.º29 of 2017. A Bill for an act to amend the environmental levy Act 2015. [Online] <http://www.fiji.gov.fj/getattachment/c2c4adb3-7893-4bb8-b45c-bb4d3f567a42/BILL-NO--29-OF-2017---FOR-AN-ACT-TO-AMEND-THE-ENVI.aspx>
- Fiji Department of Environment (2017) Introduction of Plastic Shopping Bag Reduction. Ocean Conference, United Nations 5-9 June 2017. [Online] <https://oceanconference.un.org/commitments/?id=19994>
- Finnish Ministry of Environment (2016) Green Deal agreements. Helsinki, October 28th, 2016. [Online] http://www.ymp.fi/en-US/The_environment/Waste/Green_Deal_agreements
- Finnish Ministry of Environment (2016) Green Deal: Framework agreement to reduce the consumption of lightweight plastic carrier bags (Plastic Carrier Bag Agreement). Helsinki, October 31st, 2016.
- Fleury, J. (2012) Mumbai aims at total ban on plastic bags. The Times of India. Published June 16th, 2012 [Online] <https://timesofindia.indiatimes.com/city/mumbai/Mumbai-aims-at-total-ban-of-plastic-bags/articleshow/14168500.cms>
- Fondazion ACRA (2017) Excess Baggage – Reducing plastic bag waste in major cities of Cambodia. Switch-Asia March-April 2017 Newsletter [Online] <http://www.switch-asia.eu/projects/reducing-plastic-bag-waste/>
- Foodstuffs (2017) Reducing plastic bag usage. [Online] <https://www.foodstuffs.co.nz/reducing-plastic-bag-usage/>

- Fortun, L.L. (2013) Plastic Bag Regulation Act of 2013. Republic of the Philippines, House of Representatives 16th Congress. House Bill No. 359. July 1st, 2013. [Online] http://www.congress.gov.ph/legisdocs/basic_16/HB00359.pdf
- Future Centre Trust (2017) No Plastic Bags. [Online] <http://futurecentretrust.org/main/projects-programmes/no-plastic-bags>
- Galapagos Conservancy (2014) New resolution in Galapagos will phase out plastic bags. Published December 16th, 2014 [Online] <https://www.galapagos.org/newsroom/galapagos-bans-plastic-bags/>
- Gallo, F. (2016) Prevention instruments on plastic bags: voluntary agreements. Regional Activity Center for Sustainable Consumption and Production. [Powerpoint presentation] Regional Meeting on the further implementation of the Regional plan on the management of the marine litter in the Mediterranean, July 19-20, 2016. Tirana, Albania.
- General Assembly of the State of Missouri (2015) House Bill No. 722. 98th General Assembly: First regular session [Online] <http://house.mo.gov/billtracking/bills151/billpdf/truly/HB0722T.PDF>
- The General Court of the Commonwealth of Massachusetts (2016) An Act reducing plastic bag pollution. Presented by James B. Eldridge. 190th General Court. [Online] <https://malegislature.gov/Bills/190/S424>
- German Trade Association (2016) Many plastic bags on 1 July paid. June 23rd, 2016. [Online] <http://www.einzelhandel.de/index.php/presse/pressearchiv/item/126696-viele-kunststoff%C3%BCten-zum-1-juli-kostenpflichtig>
- German Trade Association (2016) Trade initiative against plastic waste – Many plastic bags are paid for. April 26th, 2016 [Online] <http://www.einzelhandel.de/index.php/presse/pressearchiv/item/126525-handelsinitiative-gegen-plastikm%C3%BCll-viele-kunststoff%C3%BCten-werden-kostenpflichtig>
- Gobierno constitucional de Aguascalientes (2010) Ley de proteccion ambiental para el estado de Aguascalienter. Official Gazette No. 43. Published October 25th, 2010 [Online] <http://www.aguascalientes.gob.mx/IMAE/Leyes/pdfs/LPAEA.pdf>
- Gobierno de Cantabria (2010) Boletin Oficial de Cantabria; Titulo 1 – Medidas fiscales. BOC Extraordinario Num. 33. Published December 27th, 2010. pp. 2265-2267 [Online] <http://www.agenciacantabratributaria.es/documents/2082094/2082729/LEY112010IMPUESTOBOLSAS.pdf>
- Gobierno de la Ciudad Autonoma de Buenos Aires (2016) Bolsas plasticas [Online] <http://www.buenosaires.gob.ar/agenciaambiental/residuos/bolsas>

- Gobierno de la Provincia del Neuquen (2012) Sancionan una ley que prohíbe el uso de bolsas de plástico no degradables. Ministerio de Gobierno y Justicia. Published September 27th, 2012. [Online] <http://www.neuqueninforma.gob.ar/sancionan-una-ley-que-prohibe-el-uso-de-bolsas-de-plastico-no-degradables/>
- Gobierno del Chubut (2010) Boletín Oficial No. 10993. Decreto Provincial – Ley XI No. 31. Published June 1st, 2010 [Online] <http://www.chubut.gov.ar/portal/medios/uploads/boletin/Junio%2001,%202010.pdf>
- Govern d'Andorra (2017) Reglament per a la reducció del consum de les bosses de plàstic. Ministeri de Medi Ambient, Agricultura i Sostenibilitat. Andorra la Vella, May 22nd, 2017. [Online] https://www.mediambient.ad/images/stories/PDF/temes-interes/Reglament_BossesPlastic.pdf
- Government of the Azores (2017) Sacos de Plástico. [Online] <http://www.azores.gov.pt/Gra/srrn-residuos/conteudos/livres/Sacos.htm>
- Government of Canada (2017) Industry Profile for the Canadian Plastic Products Industry. Last updated January 4th 2014. [Online] <https://www.ic.gc.ca/eic/site/plastics-plastiques.nsf/eng/pl01383.html>
- Government of Fiji Gazette Supplement (2017) Environment and Climate Adaptation Levy (Plastic Bags) Regulations 2017. Legal Notice No. 61. Published August 1st 2017. [Online] [http://www.fiji.gov.fj/getattachment/a3ed8423-57c1-472f-b255-6d841f0968e2/Environment-and-Climate-Adaptation-Levy-\(Plastic-B.aspx](http://www.fiji.gov.fj/getattachment/a3ed8423-57c1-472f-b255-6d841f0968e2/Environment-and-Climate-Adaptation-Levy-(Plastic-B.aspx)
- Government of Goa (2002) Goa non-biodegradable garbage (control) Act, 1996. Official Gazette, Series II No. 52. Department of Science, Technology & Environment. Published March 30th, 2002. [Online] <https://www.goa.gov.in/wp-content/uploads/2016/05/Goa-Non-Biodegradable-Garbage-Control-1996.pdf>
- Government of Manitoba (2014) Recycling and Waste Reduction: A discussion paper. Part of Tomorrow Now, Manitoba's Green Plan. [Online] http://www.gov.mb.ca/sd/envprograms/recycling/pdf/mb_recycling_strategy_2014.pdf
- Government of Mauritius (2015) The Environment Protection Act – Environment Protection (Banning of Plastic Bags) Regulations 2015. The Government gazette of Mauritius No. 81. Government Notice No. 153 of 2015. Published August 6th, 2015. pp. 1175-1178
- Government of Morocco (2015) Dahir no. 1-15-148 du 25 safar 1437 (7decembre 2015) portant promulgation de la loi no.77-15 portant interdiction de la fabricatin, de l'importation, de l'exportation, de la commercialisation et de l'utilisation de sacs en matières plastiques. Official Gazette No. 6422 -5 rabii I 1437. Published December 12th, 2015. pp. 4435-4436
- Government of the Netherlands (2015) What does the ban on free plastic bags entail for consumers? Ministry of Infrastructure and the Environment. [Online]

<https://www.government.nl/topics/environment/ban-on-free-plastic-bags/what-does-the-ban-on-free-plastic-bags-entail-for-consumers>

Government of the Northwest Territories (2017) FAQ - Single-use retail bag program. Environment and Natural Resources [Online]

<http://www.enr.gov.nt.ca/en/services/single-use-retail-bag-program/faq-single-use-retail-bag-program>

Government of Pakistan (2013) Prohibition of Non-degradable Plastic Products (manufacturing, sale and usage) Regulations 2013. Pakistan Environmental Protection Agency (Ministry of Climate Change). The Gazette of Pakistan January 23rd, 2013 [Online] <http://environment.gov.pk/act-rules/Plasticbags%20Regulation%202013.pdf>

Government of the Republic of Slovenia (2017) 142nd Government Session. Published July 6th, 2017. [Online Press Release] http://www.vlada.si/en/media_room/government_press_releases/press_release/article/142nd_government_session_60112/

Government of Western Australia (2017) WA Plastic Bag Ban. Department of Water and Environmental Regulation. [Online] <https://www.der.wa.gov.au/your-environment/wa-plastic-bag-ban>

Governo do Estado de Goias (2013) Lei No. 16.268, de 29 de Maio de 2008. Gabinete Civil da Governadoria – Superintendencia de Legislacao. [Online] http://www.gabinetecivil.goias.gov.br/leis_ordinarias/2008/lei_16268.htm

Governo do Rio de Janeiro (2012) Uso consciente das sacolas plasticas – Consumo sustentavel V. Published May 18th, 2012 [Online] <http://www.procon.rj.gov.br/index.php/publicacao/detalhar/213>

Governo dos Acores (2017) Marta Guerreiro says the azores are reaching more demanding targets in urban waste processing. Published May 17th, 2017 [Online] http://www.azores.gov.pt/Portal/en/entidades/sreat/noticias/Marta_Guerreiro_says_the_Azores_are_reaching_more_demanding_targets_in_urban_waste_processing.htm

GRET (2013) Banning plastic bags in Mauritania. Published February 13th, 2013. [Online] <http://www.gret.org/2013/02/banning-plastic-bags-in-mauritania/?lang=en>

Gutierrez, Anchia, and Shackelford (2017) Costa Rica paves the way to end single-use plastics. United Nations Environment Programme. Published July 18th, 2017 [Online] <http://www.undp.org/content/undp/en/home/blog/2017/7/14/Costa-Rica-abre-el-camino-hacia-el-fin-de-los-plasticos-de-un-solo-uso.html>

Guyana Ministry of Communities (2017) Putting waste in its place : A national integrated solid waste management strategy for the Cooperative Republic of Guyana 2017-2030. [Online] <http://chpa.gov.gy/images/PDF/GuyanaNSWMS.pdf>

- Hartford, S. (2014) Coop Sweden works to reduce plastic bag usage. European Supermarket Magazine. Published June 1st, 2017. [Online] <https://www.esmmagazine.com/coop-sweden-works-reduce-plastic-bags/43980>
- Hattam, J. (2011) Blissful Turkish Aegean island gets just a little bit more beautiful with new plastic bag ban. Tree Hugger, Published June 5th, 2011 [Online] <https://www.treehugger.com/corporate-responsibility/blissful-turkish-aegean-island-gets-just-a-little-bit-more-beautiful-with-new-plastic-bag-ban.html>
- Hayne, J. (2017) What difference did the plastic bag ban make to Canberra's waste. Published April 9th, 2017 [Online] <http://wastemanagementreview.com.au/ban-the-bag-debate/>
- Hellenic Government (2017) Official Gazette of the Government. Issue 2, No.º2812. Decree No.º180036/952 for the Determination of measures and rules for the reduction plastic bag consumption in accordance with EU Directive 2015/720. Published August 10th, 2017.
- Hernandez-Sanchez, J. (2017) Reformas a la ley de residuos solidos del Distrito Federal. El sol de Mexico. Published September 2nd, 2017 [Online] <https://www.elsoldemexico.com.mx/metropoli/cdmx/Reformas-a-la-Ley-de-Residuos-S%C3%B3lidos-del-Distrito-Federal-249270.html>
- The Hindu (2010) Karwar CMC bans use of plastic. Published August 9th, 2010 [Online] <http://www.thehindu.com/todays-paper/tp-national/tp-karnataka/Karwar-CMC-bans-use-of-plastic/article16125184.ece>
- The Hindustan Time (2016) Ban on plastic bags in urban areas in Punjab from April 1. Published February 18th, 2016 [Online] <http://www.hindustantimes.com/punjab/ban-on-plastic-bags-in-urban-areas-from-apr-1/story-My1jnAaTGxhxYtaTk2AB7O.html>
- Hong Kong Environmental Protection Department (2007) Overseas experience on plastic shopping bag reduction. Legislative Council – Panel on Environmental Affairs. [Online] http://www.epd.gov.hk/epd/english/news_events/legco/files/OverseasExperienceonPlasticShoppingBagReduction.pdf
- Honorable Concejo Deliberante de la Ciudad de El Calafate (2006) Ordenanza No. 1018/H.C.D/06. Sanctioned September 26th, 2006 [Online] <http://www.hcdelcalafate.gov.ar/files/1018-06.PDF>
- Hoskings, R. & Tyson, D. (2007) The plastic bag debate. The Telegraph: published November 27th 2007 [Online] <http://www.telegraph.co.uk/news/earth/earthcomment/3316094/The-plastic-bag-debate.html>

- Hurriyet Daily News (2016) Plastic bags to be banned in Istanbul's Princes' Islands. Published February 19th, 2016 [Online] <http://www.hurriyetaidailynews.com/plastic-bags-to-be-banned-on-istanbul-princes-islands-95429>
- Hussain, S. (2017) Maharashtra Government to ban plastic bags completely next year. Homegrown India, published September 15th, 2017 [Online] <https://homegrown.co.in/article/801706/maharashtra-govt-moves-to-completely-ban-use-of-plastic-bags>
- Icelandic Environment Ministry (2016) Action plan to reduce the use of plastic bags. [Online] https://www.stjornarradid.is/media/umhverfissraduneyti-media/media/PDF_skrar/250816-Adgerdaraaetlun-plastpokar.pdf
- IKEA (2008) The results are in ... over 92% of IKEA customers bagged the plastic bag. Conshohocken, PA. Published April 2nd, 2008. [Online Press Release] http://www.ikea.com/ms/en_US/about_ikea/press_room/press_release/national/blue_bag_thank_you.html
- IKEA Canada (2009) IKEA Canada to ban plastic bags. Published April 13th, 2009. [Online] http://www.ikea.com/ca/en/about_ikea/newsitem/2009_plastic_bags
- Illinois General Assembly (2016) Amendment to House Resolution 1139. 99th General Assembly. [Online] <http://www.ilga.gov/legislation/fulltext.asp?DocName=09900HR1139ham001&GA=99&LegID=97340&SessionId=88&SpecSess=0&DocType=HR&DocNum=1139&GAID=13&Session=>
- India Today (2015) Uttar Pradesh government bans polythene bags in the state: Harmful effects of plastic. New Delhi, December 22nd, 2015. [Online] <http://indiatoday.intoday.in/education/story/uttar-pradesh-government-bans-polythene-bags/1/553256.html>
- The Indian Express (2015) Maharashtra ban on plastic carry bags comes into force. Published February 24th, 2015 [Online] <http://indianexpress.com/article/india/india-others/maharashtra-ban-on-plastic-carry-bags-comes-into-force/>
- The Indian Express (2017) Kerala: Blanket ban on plastic bags in Thiruvananthapuram. Published March 5th, 2017 [Online] <http://indianexpress.com/article/cities/thiruvananthapuram/blanket-ban-on-plastic-bags-in-thiruvananthapuram-4555646/>
- Indiana General Assembly (2016) House Enrolled Act No. 1053. Second Regular Session of the 119th General Assembly. [Online] <https://iga.in.gov/legislative/2016/bills/house/1053#document-d2328d28>
- Institut National d'Études Démographiques (2015) Imagine the population of tomorrow. [Online] https://www.ined.fr/en/everything_about_population/population-games/tomorrow-population/

- Iowa Legislature (2017) House File 295. [Online] <https://www.legis.iowa.gov/legislation/BillBook?ga=87&ba=hf295>
- Ireland Department of Housing, Planning, Community and Local Government (2016) Plastic bag levy. [Online] <http://www.housing.gov.ie/environment/waste/plastic-bags/plastic-bag-levy>
- IRIN News (2010) Just say no to plastic bags. Published November 24th, 2010 [Online] <http://www.irinnews.org/news/2010/11/24/just-say-no-plastic-bags>
- IRIN (2011) Plastics proliferate despite ban. Dhaka, 2 March 2011. [Online] <http://www.irinnews.org/report/92072/bangladesh-plastics-proliferate-despite-ban>
- Island Times (2017) House pass plastic ban bill on final reading. Published August 4th, 2017. [Online] <http://islandtimes.us/house-pass-plastic-ban-bill-on-final-reading/>
- Israel Ministry of Environmental Protection (2017) Reducing plastic bag use in Israel. Last updated January 19th, 2017. [Online] http://www.sviva.gov.il/English/env_topics/Solid_Waste/Pages/Supermarket-Bags.aspx
- Italian Chamber of Deputies (2016) National rules on the marketing of non-biodegradable plastic bags (shoppers). Services and Offices of the Chamber. Published January 11th, 2016. [Online] <http://www.camera.it/temiap/t/news/post-OCD15-10929>
- Jaliff, Petri, Vicchi & Manzitti (2005) Ley 7319. Provincia de Mendoza, Ministerio de Ambiente y Obras Publicas. Mendoza, January 1st, 2005 [Online] <http://www.estrucplan.com.ar/Legislacion/Mendoza/Leyes/Ley07319.asp>
- Jaliff, Rodriguez, marin & Manzitti (2007) Modificatoria de la ley 7319 obre prohibicion de entrega de bolsas materiales no biodegradables. Boletin Oficial, October 22nd, 2007. [Online] Jaliff, Rodriguez, marin & Manzitti, 2007
- Jalil et al. (2013) Using Plastic Bags and its Damaging Impact on Environmental and Agriculture: An Alternative Proposal. Published on August 17th 2013. International Journal of Learning & Development Vol. 3, No. 4
- Japan for Sustainability (2008) Charge for plastic shopping bags begins throughout Toyama Prefecture. Posted August 8th, 2008. [Online] https://www.japanfs.org/en/news/archives/news_id027108.html
- Japan Ministry of Environment (2012) Survey on plastic bags (FY 2011). [Online] https://www.env.go.jp/recycle/yoki/c_1_questionnaire/questionnaire_23_b_4_1_1.htm
- Johnston, I. (2017) India just banned all forms of disposable plastics in its capital. The Independent. Published January 25th, 2017 [Online] <http://www.independent.co.uk/news/world/asia/india-delhi-bans-disposable-plastic-single-use-a7545541.html>

- Kagame, Makuza & Karugarama (2008) Law No. 57/2008 of 10/09/2008 Relating to the prohibition of manufacturing, importation, use and sale of polyethylene bags in Rwanda. Official Gazette of the Republic of Rwanda, No. 12bis. Published March 23rd, 2009. pp. 78-86
- Kamat, P. (2017) Goa bans thin plastic bags to tackle garbage. The Hindu, published May 30th, 2017. [Online] <http://www.thehindu.com/news/national/other-states/goa-bans-thin-plastic-bags-to-tackle-garbage/article18622435.ece>
- Karstens-Smith, G. (2014) Retailers going bag to free plastic bags. The Star, Published June 14th, 2014 [Online] https://www.thestar.com/business/2014/06/14/retailers_going_back_to_free_plastic_bags.html
- Kathmandu Post (2017) Plastic bag ban proves to be just a fanciful idea. Posted July 28th, 2017. [Online] <http://kathmandupost.ekantipur.com/news/2017-07-28/plastic-bag-ban-proves-to-be-just-a-fanciful-idea.html>
- Kazda, K. (2014) The Plastic Bag Proble. Sustainable America. Posted June 9th, 2014 [Online] <http://www.sustainableamerica.org/blog/the-plastic-bag-problem/>
- Keep Australia Beautiful (2017) Northern Territory plastic bag ban (5 year litter performance review). Published January 12th, 2017 [Online] <http://kabcnt.org.au/northern-territory-plastic-bags-ban-5-year-litter-performance-review/>
- Keita, I.B. (2014) Loi No. 2014-024 du 3 juillet 2014 portant interdiction de la production, de l'importation et de la commercialisation des sachets plastiques non biodégradables en République du Mali. Journal Officiel de la République du Mali. Published July 3rd, 2014. p.126
- Kèko, I. (2017) Interdiction des sachets plastiques au Bénin : Une proposition de loi sur la table des députés. La Nouvelle Tribune. Published February 16th, 2017. [Online] <https://lanouvelletribune.info/archives/benin/politique/32193-interdiction-sachets-proposition-loi>
- Kraut, A. (2016) Montgomery County relauches bag tax campaign as fee collections remain high. Bethesda Magazine, Published June 20th, 2016 [Online] <http://www.bethesdamagazine.com/Bethesda-Beat/Web-2016/Montgomery-County-Relauches-Bag-Tax-Campaign-As-Fees-Collections-Remain-High/>
- Kroyer, A.M. (2015) Fact Sheet: Tax on plastic bags. The Danish Ecological Council. Published August 12th, 2015 [Online] <https://www.ecocouncil.dk/en/documents-3/temasider/1776-150812-tax-on-plastic-bags>
- Landais, E. (2010) Ajman bans non-biodegradable bas. Gulf News: Environment. Published January 21st, 2010. [Online] <http://gulfnews.com/news/uae/environment/ajman-bans-non-biodegradable-bags-1.571136>

- Langenheim, J. (2017) Indonesia pledges \$1bn a year to curb ocean waste. The Guardian. Published March 2nd, 2017. [Online] <https://www.theguardian.com/environment/the-coral-triangle/2017/mar/02/indonesia-pledges-us1-billion-a-year-to-curb-ocean-waste>
- Larsen, J. and Venkova, S. (2014) The Downfall of the Plastic Bag: A Global Picture. Published May 1st, 2014. [Online] http://www.earth-policy.org/plan_b_updates/2014/update123
- Laurence, D. & Bonnelame, B. (2017) In effort to phase out plastic from Seychelles, government steps up enforcement. Seychelles News Agency. Published February 17th, 2017 [Online] <http://www.seychellesnewsagency.com/articles/6766/In+effort+to+phase+out+plastic+from+Seychelles%2C+government+steps+up+enforcement>
- LaVoz (2011) Confusion por el tipo de bolsas plasticas que permite la ley. Published March 9th, 2011. [Online] <http://www.lavoz.com.ar/ciudadanos/confusion-tipo-bolsas-plasticas-que-permite-ley>
- Legard, L.B. (2014) Plastic Bag Regulation Act of 2014. Senate of the Philippines, 16th Congress. Senate Bill No. 2415. Filed September 18th, 2014. [Online] https://www.senate.gov.ph/lis/bill_res.aspx?congress=16&q=SBN-2415
- Legimonaco (2017) Ordonnace n.5.831 du 09/05/2016 relative aux sac et ustensils en plastique. Journal de Monaco du 13 mai 2016. Gouvernemnt Princier : Principaute de Monaco. [Online] <http://www.legimonaco.mc/305/legismclois.nsf/ViewTNC/FB67D3113A617A86C1257FCC002AE064!OpenDocument>
- Legislacion de la Provinica de Cordoba (2009) Ley No. 9696. [Online] <http://web2.cba.gov.ar/web/leyes.nsf/0/D7C6F9AB6756B6A10325767E00683ACC?OpenDocument&Highlight=0,9696>
- Legislatura constitucional del estado libre y soberano de Quintana Roo (2015) Ley para la prevencion y la gestion integral de residuos del estado de Quintana Roo. Published in the Official Gazette on March 30th, 2015. [Online] http://legismex.mty.itesm.mx/estados/ley-quin/QR-L-PrevGesInteRes2015_03.pdf
- Legislatura del Estado de Zacatecas (2010) Ley de residuos solidos para el estado de Zacatecas. Published October 16th, 2010 [Online] <http://www.congreso Zac.gob.mx/e/articulo&art=33783&ley=156&tit=0&cap=0&sec=0>
- Legislature San Luis Potosi (2015) Ley Ambiental del Estado de San Luis Postosi. Articles 104 & 107. March 25th, 2014 [Online] <http://www.ordenjuridico.gob.mx/Documentos/Estatal/San%20Luis%20Potosi/wo95741.pdf>
- Legislature of American Samoa (2010) House Bill No. 31-4. Public law No. 31. The Thirty-First Legislature of American Samoa: Third regular session. [Online] http://www.epa.as.gov/sites/default/files/documents/plastic_ban/plasticbagban.pdf

- Legislature of the State of Idaho (2016) House Bill No. 372. Sixty-third legislature: Second regular session – 2016. In the House of Representatives [Online] <https://legislature.idaho.gov/wp-content/uploads/sessioninfo/2016/legislation/H0372.pdf>
- Legislature of the Virgin Islands (2016) Bill No. 31-0379. 31st legislature of the Virgin Islands: Regular session 2016. Approved September 20th, 2016 [Online] <http://www.viωμα.org/images/PDFDOCS/plasticbagban.pdf>
- Le Monde Afrique (2017) Pour lutter contre la pollution, le Kenya bannit les sacs en plastique. Le Monde.fr. Published August 28th, 2017. [Online] http://www.lemonde.fr/afrique/article/2017/08/28/pour-lutter-contre-la-pollution-le-kenya-bannit-les-sacs-en-plastique_5177680_3212.html
- Les Naturalistes de Mayotte (2014, November 4th) 2014-11-04 JT Mayotte 1ere – Interdiction des sacs plastiques à Mayotte à partir de 2016. [Video File] Retrieved from <https://www.youtube.com/watch?v=sylUxiU2eOs>
- Leung, C.Y. (2014) Product Eco-responsibility (Amendment) Ordinance 2014. Hong Kong Special Administrative Region. Ordinance No.4 of 2014. Enacted by the Legislative Council. [Online] <https://www.elegislation.gov.hk/hk/2014/4!en>
- Live Mint (2017) NGT bans use of non-biodegradable plastic bags in Delhi. Published August 10th, 2017 [Online] <http://www.livemint.com/Politics/ifvbNDgrPjKNMRHY81hZzM/NGT-bans-use-of-nondegradable-plastic-bags-in-Delhi.html>
- The Local (2017) Plastic bags on the way out in Austria's supermarkets. Published January 16th, 2017. [Online] <https://www.thelocal.at/20170116/plastic-bags-on-the-way-out-in-austrias-shops-and-supermarkets>
- Logistica (2009) Comienza la prohibicion de entregar bolsas plasticas en la provinica de Buenos Aires. Published October 14th, 2009. [Online] <http://www.logisticasud.enfasis.com/notas/14609-comienza-la-prohibicion-entregar-bolsas-plasticas-la-provincia-buenos-aires>
- Loukoula, J.M. (2016) Sac en plastique : la guerre continue! Agence d'information d'Afrique Centrale. Published November 18th, 2016. [Online] <http://adiac-congo.com/content/sacs-en-plastique-la-guerre-continue-58157>
- Luxembourg Environnement et Gestion de l'Eau (2017) Loi du 21 mars 2017 relative aux emballages et aux dechets d'emballages. Journal Officiel du Grand-Duche de Luxembourg. Published March 27th, 2016. [Online] <http://legilux.public.lu/eli/etat/leg/loi/2017/03/21/a330/jo>
- Lyons, Withana & Faria (2013) Case Study : Reducing plastic bag use in the UK and Ireland. Dynamix, July 2013. p.33 [Online] http://dynamix-project.eu/sites/default/files/Plastic%20bags_Ireland%20and%20UK.pdf

- Mahafaly-S., O. (2017) Décret No. 2017-10 Portant interdiction de la production, de l'importation, de la commercialisation, de la constitution de stock et de l'utilisation des sachets et des sacs en plastique sur le territoire national. Madagascar Ministry of Environment, Ecology and Forests. Antananarivo, January 3rd, 2017. [Online] https://upload.wikimedia.org/wikipedia/commons/thumb/d/d1/Flag_of_Malawi.svg/1280px-Flag_of_Malawi.svg.png
- Maine Department of Environmental Protection (2016) Waste Management: Plastic bag and plastic film recycling. [Online] <http://www.maine.gov/dep/waste/recycle/plastic-bag-film.html>
- Maldives Customs Service (2017) Customs Statistics [Online] <https://www.customs.gov.mv/Statistics>
- Maldives Getaways (2015) Bodufolhudhoo becomes first island in Maldives to ban single-use plastic bags. Published December 6th, 2015 [Online] <http://www.guesthousesofmaldives.com/bodufolhudhoo-becomes-first-island-in-maldives-to-ban-single-use-plastic-bags/>
- Maldives Getaways (2016-A) Dhiraagu to support Keyodhoo's single-use plastic bag ban initiative. Published December 22nd, 2016 [Online] <http://guesthouses.mv/dhiraagu-to-support-keyodhoos-single-use-plastic-bag-ban-initiative/>
- Maldives Getaways (2016-B) Ukulhas joins "Ban the Bags" campaign to ban single-use plastic bags from 1st January 2017. Published December 28th, 2017 [Online] <http://guesthouses.mv/ukulhas-joins-ban-the-bags-campaign-to-bans-single-use-plastic-bags-from-1st-january-2017/>
- Malta Chamber of SMEs (2016) Excise duty on plastic bags, sacks, cones, films, sheets and tubes. [Online] <http://www.grtu.org.mt/index.php/publications/publications-after-2010/publications-in-2016/3560-excise-duty-on-plastic-bags-sacks-cones-films-sheets-or-tubes>
- Mariana's Variety (2014) Yap bans plastic bags. Pacific/Regional News. Press release published July 9th, 2014 [Online] <http://www.mvariety.com/regional-news/67044-yap-bans-plastic-bags>
- Marino, M. (2004) Birregurra bins the plastic bag. Fairfax Media – The Age. Published October 9th, 2004 [Online] <http://fdp.theage.com.au/articles/2004/10/08/1097089567097.html?from=storylhs>
- Martinki, K. (2017) Tunisia bans disposable plastic shopping bags. Tree Hugger. Published March 23rd, 2017. [Online] <https://www.treehugger.com/environmental-policy/tunisia-bans-disposable-plastic-shopping-bags.html>
- McClatch, J.C. & McClatch, C.M. (2012) Haiti bans plastic bags and styrofoam containers. The Christian Science Monitor. Published September 12th, 2012 [Online]

<https://www.csmonitor.com/World/Americas/2012/0928/Haiti-bans-plastic-bags-and-styrofoam-containers>

McLaughlin, M. (2016) Ban, Fee, Take-Back/Recycle: Which Approach Wins Out in the End? (Master's Thesis) Submitted to the University of New Hampshire, May 2016.

McLaughlin, M. & Halstead, J. (2016) The ubiquitous plastic bag – and what to do. *BioCycle*. Volume 57, No 7, p. 38. Published August 2016

Menabdishvili, M. (2017) Plastic bags to be banned in Georgia from September. *The Georgian Journal*. Published March 28th, 2017. [Online] <https://www.georgianjournal.ge/society/33441-plastic-bags-to-be-banned-in-georgia-from-september.html>

Mercilla-Revilla, L. (2013) Plastic Bag Regulation Act of 2013. Republic of the Philippines, House of Representatives 16th Congress. House Bill No. 106. July 1st, 2013. [Online] http://www.congress.gov.ph/legisdocs/basic_16/HB00106.pdf

Michelot, P. (2014) C'est fini pour le sac plastique au Cameroun. *L'encre Noir*. Published April 30th, 2014. [Online] <http://lencrenoir.com/cest-fini-pour-le-sac-plastique-au-cameroun/>

Ministères Économiques et Financiers (2017) Les sacs en plastiques jetables, c'est fini! Le Portail de l'Économie, des Finances, de l'Action et des Comptes public. Direction générale de la concurrence, de la consommation et de la répression de fraudes. Published January 2nd, 2017. [Online] <https://www.economie.gouv.fr/dgccrf/sacs-en-plastique-jetables-cest-fini>

Ministerio de Agricultura y Pesca, Alimentacion y Media Ambiente (2017) Proyecto de real decreto sobre reduccion del consume de bolsas de plastic y por el que se cera el registro de productores de productos (REPP). Secretaria de Estado de Medio Ambiente – Direccion general de calidad y evaluacion ambiental y medio natural. Published July 25th 2017. [Online] http://www.mapama.gob.es/es/calidad-y-evaluacion-ambiental/participacion-publica/170725rdbolsasyrepp_tcm7-462536.pdf

Ministerio de Gobierno Buenos Aires Provincia (2008) Ley 13868. El Senado y Camara de Diputados de la Provincia de Buenos Aires. [Online] <http://www.gob.gba.gov.ar/legislacion/legislacion/l-13868.html>

Mnisterios das Financas et do Ambiente, do Ordenamento do Territorio e Energia (2014) Portaria n.º286-B/2014. Ordinance relating to plastic bgas. Published December 31st, 2014. [Online] <https://dre.pt/application/file/66014856>

Ministry of Environment (2017-A) Plastic bags, new regulations. Published January 11th, 2017. [Online] <http://www.mediu.gov.md/index.php/serviciul-de-presaNoutati/2604-pungile-de-plastic-noi-reglementari>

- Ministry of Environment (2017-B) Marketing of plastic bags in commercial units – forbidden. Published July 7th, 2017. [Online] <http://www.mediu.gov.md/index.php/serviciul-de-presa/noutati/2684-comercializarea-pungilor-de-plastic-in-unitatile-comerciale-interzisa>
- Ministry of Environment of the Republic of Lithuania (2016) Retailers will no longer be allowed to hand out plastic carrier bags free of charge. Published June 16th, 2016. [Online] http://www.am.lt/VI/en/VI/article.php3?article_id=823
- Mir, R. (2018) Around 55 billion plastic shopping bags being used amid 15% rise per annum. Urdu News, Published January 18th, 2018 [Online] <https://www.urdupoint.com/en/pakistan/around-55-bln-plastic-shopping-bags-being-use-251730.html>
- Mishra, A. (2017) Plastic ban in India. EcoRight [Online] <https://ecorightbags.com/2017/04/19/plastic-ban-in-india/>
- Missouri House of Representatives (2015) House Bill 722: Bill Actions. [Online] <http://house.mo.gov/BillActionsPrn.aspx?bill=HB722&year=2015&code=R>
- Mizzima News (2009) Ban on polythene bags in Naypyitaw. Published October 20th, 2009 [Online] <http://archive-1.mizzima.com/news/myanmar/2932-ban-on-polythene-bags-in-naypyitaw>
- Mohamed, M. (2016) State of the Environment 2016. Ministry of Environment and Energy- Republic of the Maldives. Handhuvaree Hingun, Male, Madives.
- Moniteur Belge (2007) Loi, Decrets, Ordonnances et Reglement. No.°180. 3^e ed. Bruxelles, June 5th, 2007. p. 32862 - 32863
- Morin, C. (2017) Niger: suppression progressive des sacs en plastique. Tribune Ouest. Published August 18th, 2017. [Online] <https://tribuneouest.com/2017/08/18/niger-suppression-progressive-sac-plastique/>
- Moudgali, S. (2016) Total plastic ban in Karnataka. The Times of India. Published March 14th, 2016. [Online] <https://timesofindia.indiatimes.com/city/bengaluru/Total-plastic-ban-in-Karnataka/articleshow/51397198.cms>
- Mousmouti, M. (2014) The “effectiveness test” as a tool for law reform. IALS Student Law Review. Volume 2 Issue 1, Autumn 2014 Special Issue, pp. 4-8
- Mozambique Council of Ministers (2015) Decreto no.16/2015 – Regulamento sobre a gestao e control do saco de platicon. Republic of Mozambique Official Gazette No. 62, Serie 1. Published August 5th, 2015 [Online] <http://zitamar.com/wp-content/uploads/2016/01/Plastic-bag-law.pdf>
- MRC de Marguerite-d’Youville (2017) Portrait du territoire. [Online] <http://margueritedyouville.ca/territoire/portrait-du-territoire/>

- Mtulya, A. (2016) Tanzania : Plastic bags ban still Jan 1, says govt. All Africa – The Citizen. Published October 22nd, 2016. [Online] <http://allafrica.com/stories/201610220203.html>
- Mudgal, Lyons, Kong, André, Monier & Labouze (2011) Assessment of impacts of options to reduce the use of single-use plastic carrier bags. Bio Intelligence Service. September 11th, 2011
- Multi-Material Stewardship Manitoba (2014) Annual Report – 2014. Winnipeg, Manitoba. [Online] <http://stewardshipmanitoba.org/wp-content/uploads/2013/10/MMSM-Annual-Report-for-20142.pdf>
- Muluzi, A. (2015) Environment Management Act – Environment Management (Plastics) Regulations, 2015. The Malawi Gazette : Government Notice No.4. March 27th, 2015. pp. 69-71.
- Namib Times (2017) Swakopmund uses about 25 million shopping bags annually. Published October 17th, 2017 [Online] <http://namibtimes.net/swakopmund-uses-about-25-million-shopping-bags-annually/>
- National Conference of State Legislatures (2016) State Plastic and Paper Bag Legislation. [Online] <http://www.ncsl.org/research/environment-and-natural-resources/plastic-bag-legislation.aspx>
- National Geographic (2017) Great Pacific Garbage Patch. [Online] <https://www.nationalgeographic.org/encyclopedia/great-pacific-garbage-patch/>
- National Geographic (2017) Ocean Gyre. [Online] <http://nationalgeographic.org/encyclopedia/ocean-gyre/>
- National Oceanographic and Atmospheric Administration (2014) Ingestion: Occurrence and Health Effects of Anthropogenic Debris Ingested by Marine Organisms. 2014 NOAA Marine Debris Program Report. Published April 2014. Silver Spring, MD. 19pp.
- Nelson, E. (2017) Legislature blocks plastic bag ban in Minneapolis. The Star Tribune. Published May 31st, 2017 [Online] <http://www.startribune.com/state-legislature-blocks-plastic-bag-ban-in-minneapolis/425517333/>
- The New Indian Express (2017) Goa to ban plastic bags from May next year. Published December 19th, 2017 [Online] <http://www.newindianexpress.com/nation/2017/dec/19/goa-to-ban-plastic-bags-from-may-next-year-1731229.html>
- New York State Department of Environmental Conservation (2015) NYS Plastic bag and film plastic reduction. [Online] <http://www.dec.ny.gov/chemical/50034.html>

- Nhamo, G. (2003) Waste management policy implementation in South Africa: An emerging stakeholder participation paradox. *South African Journal of Environmental Education*. Vol, 20 October 4th, 2003. pp. 39-52
- Niaounakis, M. (2017) *Management of Marine Plastic Debris*. Amsterdam, Netherlands: Elsevier.
- Nicholls, F. (2016) 6 amazing plastic bans from around the world. GreenPeace. Published on July 29th, 2016. [Online] <https://www.greenpeace.org.uk/bans-plastic-across-world-take-plastics-pledge-20160725/>
- Northern Territory Environment Protection Authority (2017) Plastic bag ban – Retailer information and resources. [Online] <https://ntepa.nt.gov.au/waste-pollution/plastic-bag-ban/retailer-information-and-resources>
- Norway Environment Agency (2015) Norwegiaans need plastic bags. Published October 5th, 2015. [Online] <http://www.miljodirektoratet.no/no/Nyheter/Nyheter/2015/Oktober-2015/Nordmenn-har-bruk-for-plastposer/>
- Norway Environment Agency (2016) Suggests to make plastic carrier bags more expensive. Published December 15th, 2016. [Online] <http://www.miljodirektoratet.no/no/Nyheter/Nyheter/2016/Desember-2016/Foreslar-a-gjore-plastbareposer-dyrere/>
- Northern Ireland Department of Agriculture, Environment and Rural Affairs (2017) Northern Ireland carrier bag levy annual statistics 2016/17. Published August 24th, 2017 [Online] https://www.daera-ni.gov.uk/sites/default/files/publications/daera/stats-carrier-bag-levy-2016-17_0.PDF
- The Northwest Company (2013) Canada’s oldest retailer reduces plastic bag usage in Nunavut & Nunavik by 67% - Greener Tomorrow Initiative achieves success in Northern Canada. Winnipeg, Manitoba. Published April 16th, 2013 [Press Release] retrieved from: http://www.northwest.ca/content/news_releases/2013_Greener_Tomorrow_Initiative_Achieves_Success_in_Northern_Canada.pdf
- Nunez, D. (2015) Recyclable shopping bag program in Ambergris Caye. *The Ambergris Today*, Published April 22nd, 2015 [Online] <https://www.ambergristoday.com/content/stories/2015/april/22/recyclable-shopping-bag-program-san-pedro-ambergris-caye>
- Obateru, T. (2016) Nigeria and the menace of plastic bags. Published April 14th, 2016 [Online] <https://globalreportingblog.wordpress.com/2016/04/14/nigeria-and-the-menace-of-plastic-bags/>
- Ohio Grocers Association (2009) Plastic bag recycling. [Online] <http://www.ohiogrocers.org/foundation/green-scene/plastic-bag-recycling/>
- Ohio State University (2017) Minimizing waste across the campus. Facilities operations and development. [Online] <https://fod.osu.edu/recycling>

- One Bag at a Time (2017) The San Francisco Bag Ban. [Online] <https://1bagatatime.com/learn/guide-bag-bans/bag-ban-san-francisco/>
- One Bag Habit (2017) About one bag habit. [Online] <http://www.onebaghabit.se/#omonebaghabit>
- Ontario Plastic Bag Reduction Task Group (2010) Progress Report, 2008/09. Published December 20th, 2010. [Online] https://monsacintelligent.ca/wp-content/uploads/2017/03/ONTARIO-BAG-REDUCTION-Progress-Report-November-26-2010_FINAL.pdf
- Orru, Boyer and Jaraudias (2005) Halte aux sacs plastiques. Annales des Mines. Published July 2005 [Online] <http://www.anales.org/re/2005/re39/orru.pdf>
- Ouattara, Al. (2013) Décrêt No^o. 2013-327 du 22 Mai 2013 portant interdiction de la production, de l'importation, de la commercialisation, de la détention et de l'utilisation des sachets plastiques. Présidence de la République de Côte d'Ivoire. Abidjan, 22 novembre 2013. [Online] <http://www.environnement.gouv.ci/img/14216635417decretportantinterdictiondessachetsplastiques.pdf>
- Page Peru (2016) El uso de las bolsas plasticas en nuestra vida. Published December 9th, 2016. [Online] <http://pageperu.org.pe/2016/12/19/el-uso-de-las-bolsas-plasticas-en-nuestra-vida/>
- Parker, L. (2015) Ocean Trash: 5.25 Trillion Pieces and Counting, but Big Questions Remain. Published January 11th 2015. National Geographic. [Online] <http://news.nationalgeographic.com/news/2015/01/150109-oceans-plastic-sea-trash-science-marine-debris/>
- Perdomo, D. (2016) Guanaja prohíbe el uso de bolsas plasticas. Buenos Noticias Honduras, published July 6th, 2016 [Online] <http://buenasnoticias.hn/2016/07/06/guanaja-prohibe-el-uso-de-bolsas-plasticas/>
- Petru, A. (2014) A Brief History of the Plastic Bag. Triple Pundit. Published November 5th 2014 [Online] <http://www.triplepundit.com/2014/11/brief-history-plastic-bag/>
- Phuntsho, S. (2013) Plastic ban still ineffective. BBS Bhutan. Published January 14th, 2013. [Online] <http://www.bbs.bt/news/?p=22302>
- Phyu, A.S. & Gaung, J.S. (2011) Plastic bags get the toss from Yangon. The Myanmar Times. Published May 2nd, 2011 [Online] <https://www.mmmtimes.com/national-news/2950-plastic-bags-get-the-toss-from-yangon.html>
- Pierre H. & Atangana, L.M.M. (2012) Arrêté conjoint No^o. 004 MINEPDED/MINCOMMERCE du 24 Oct. 2012 portant réglementation de la fabrication, de l'importation et de la commercialisation des emballages non biodégradables. République du Cameroun – Le Ministre de l'environnement, de la

protection de la nature et du développement durable ainsi que le Ministre du Commerce. Yaoundé, le 24 Octobre 2012.

- Pieters, J. (2017) Dutch ban on free plastic bags sees 71% drop in use. The Netherlands Times. Published April 18th, 2017 [Online] <https://nltimes.nl/2017/04/18/dutch-ban-free-plastic-bags-sees-71-pct-drop-use>
- Plastech (2011) Macedonia (FYROM) bans plastics bags. Published February 7th, 2011 [Online] <https://www.plastech.biz/news/Macedonia-FYROM-bans-plastics-bags-4295>
- Plastic Bag Reduction Act of 2009, H.R. 2091, 111th Congress (2009)
- Plastics Industry Association (2017) Global Marine Litter Declaration. [Online] <http://www.plasticsindustry.org/more/industry-programs-home/global-marine-litter-declaration>
- Pohnpei Legislature (2011) An act to amend Title 27 of the Pohnpei Code, by adding a new chapter 4, entitled “Control of Plastic Wastes” to prohibit the use of plastic bags in the sale or distribution of merchandise; and for other purposes. S.L.No. 7L-103-11. Seventh Pohnpei Legislature – Twelfth Regular Session 2011. L.B. No. 167-09 [Online] <http://www.fm/PohnpeiLeg/Public%20Law/SL%20No.%207L-103-11.pdf>
- The Point (2015) Plastic bag use, importation to be banned in Gambia. Published April 22nd 2015. [Online] <http://thepoint.gm/africa/gambia/article/plastic-bag-use-importation-to-be-banned-in-gambia>
- Poland Ministry of Environment (2017) Let`s use reusable bags. Published July 3rd, 2017. [Online] <https://www.mos.gov.pl/aktualnosci/szczegoly/news/korzystajmy-z-toreb-wielokrotnego-uzytku-1/>
- Portail de la Wallonie (2017) Interdiction des sacs plastique en Wallonie :état des lieux ce 1^{er} mars. Published March 3rd, 2017 [Online] <http://www.wallonie.be/fr/actualites/interdiction-des-sacs-plastique-en-wallonie-etat-des-lieux-ce-1er-mars>
- Presidencia del Congreso del Estado de Baja California (2016) Comision de medio ambiente y desarrollo sustentable. Dictamen No. 11. Approved February 25th, 2016 [Online] http://www.congresobc.gob.mx/Parlamentarias/Dictamen/11_MEDAMBIEN_25FEB2016.pdf
- Presidencia de la Republica del Paraguay (2015) Poder legislativo Ley No.º5414 de promocion de la disminucion del uso de plastic polietileno. Published May 5th, 2015.
- Presidencia de la Republica del Paraguay (2016) Por el cual se reglamenta la ley No.º5414/2015 “De promocion de la disminucion del uso de plastico polietileno”. Decreto No.º5537. Pataguay Ministerio de Industria y Comercio. Published July 30th, 2016.

- Presidencia de la Republica del Paraguay (2017) Por el cual se reglamenta el articulo 2 del Decreto No.5537/2016 “Que reglamenta la ley No.º5414/2015 de promocion de la disminucion del uso de plastic polietileno” y se establece el regimen de licencia previa de importacion de bolsas de plastic y bolsas biodegradables. Resolucion No.º353. Paraguay Ministerio de Industria y Comercio. Published March 27th, 2017
- President Guelleh (2016) Arrêté No°. 2016-284/PRE portant interdiction d’importation et de commercialisation des sacs plastiques non biodégradables, non produits en République de Djibouti. Published May 20th, 2016. [Online] <http://www.presidence.dj/texte.php?ID=2016-284&ID2=2016-04-20&ID3=Arr%EA%E9&ID4=8&ID5=2016-04-30&ID6=n>
- Prime Minister of Aruba – Mike Eman (2016) Ban on non-sustainable grocery bags. Published June 30th, 2016. [Online] <http://www.pmoaruba.com/initiatives/ban-on-non-sustainable-grocery-bags/>
- Projeto de lei No.º612 (2007). Brazil Chamber of Deputies. [Online] <http://www.camara.gov.br/proposicoesWeb/fichadetramitacao?idProposicao=346504>
- Provincia de la Rioja (2008) Boletin Oficial No. 10.592. Ley N. 8.277. Published July 15 2008, La Rioja. [Online] <http://www.boletinoflarioja.com.ar/pdf/2008//2008-07-15-B.pdf>
- Provincial Government of Bulacan (2012) Bulacan bans use of plastic bags. Published April 1st, 2012 [Online] <http://bulacan.gov.ph/newsarticle.php?id=1468>
- Pulau Pinang State Government (2011) Launching of everyday is “No Free Plastic Bag” day. Published January 15th, 2011 [Online] <https://www.penang.gov.my/en/dmedia/633-launching-of-everyday-is-no-free-plastic-bags-day>
- Queensland Government (2017) About the ban on the supply of lightweight plastic shopping bags. Last updated September 26th, 2017 [Online] <https://www.qld.gov.au/environment/pollution/management/waste/plastic-bags/about>
- Quillen, S. (2017) Tunisia bans plastic bags in supermarkets. The Arab Weekly. Published March 19th, 2017 [Online] <http://www.thearabweekly.com/Environment/8063/Tunisia-bans-plastic-bags-in-supermarkets>
- Radio New Zealand (2016) Ban on plastic bags begins in PNG. Published January 28th, 2016 [Online] <http://www.radionz.co.nz/international/pacific-news/295150/ban-on-plastic-bags-begins-in-png>
- Radio New Zealand (2017) Plastic-bag ban to benefit Solomons’ tourism. Posted June 6th, 2017 [Online] <http://www.radionz.co.nz/international/pacific-news/332369/plastic-bag-ban-to-benefit-solomons-tourism>

- Rahman, T.A. (2017) Maalhos to do away with plastic bags. The Eydhafushi Times. Published February 3rd, 2017 [Online] <http://www.eydhafushitimes.com/english/business/4934/>
- Rajput, V. (2017) Noida fails to enforce ban on use of plastic bags. The Hindustan Time, Published August 12th, 2017 [Online] <https://www.hindustantimes.com/noida/noida-fails-to-enforce-ban-on-use-of-plastic-bags/story-PFwcZ0n4uBNtQq0VqMXcZP.html>
- Ralitera, M. (2017) L'utilisation des sacs plastiques règlementée. L'Epress de Madagascar. Published May 1st, 2017. [Online] https://upload.wikimedia.org/wikipedia/commons/thumb/d/d1/Flag_of_Malawi.svg/1280px-Flag_of_Malawi.svg.png
- Recycling Council of British Columbia (2009) Thrifty Foods nixes Plastic Bags. May 2009 [Online] <https://www.rcbc.ca/membership/member-resources/recap/may09>
- Recycling Council of Ontario (2017) Plastic Bag Grab Challenge: How the plastic bag grab challenge works. [Online] <http://www.plasticbaggrab.com/>
- Regional Municipality of Wood Buffalo (2012) Bylaw No. 12/007: Single-use shopping bag bylaw. Passed April 10th, 2012 [Online] <https://www.rmwb.ca/Assets/Departments/Legislative+and+Legal+Services/Bylaws/ShoppingBag.pdf>
- Rehman, D. (2017) Plastic bags banned in Balochistan. The Daily Pakistan. Published April 16th, 2017 [Online] <https://en.dailypakistan.com.pk/pakistan/plastic-bags-banned-in-balochistan/>
- Republica de Colombia (2016) Por la cual se reglamenta el uso racioal de bolsas plasticas y se adoptan otras disposiciones. Resolucion No.º0668. Bogota D.C. El Ministerio de Ambiente y Desarrollo Sostenible. Published April 28th 2016
- Republic of Estonia Ministry of the Environment (2016) A minimum price for plastic bags will be established as of 2019 to reduce plastic bag consumption. [Online] <http://www.envir.ee/en/news/minimum-price-plastic-bags-will-be-established-2019-reduce-plastic-bag-consumption>
- Republic of the Marshall Islands (2016) Styrofoam and plastic products prohibition act 2016. 37th Constitutional Regular Session, 2016. Bill No.º28. [Online] <https://rmiparliament.org/cms/images/LEGISLATION/BILLS/2016/2016-0028/StyrofoamandPlasticProductsProhibitionAct2016.pdf>
- Republic of the Marshall Islands (2016) Styrofoam cups and plates, and plastic products prohibition, and container deposit act 2016. Bill No.º 28ND1 P.L.2016-17. [Online] <http://rmicourts.org/wp-content/uploads/P.L.2016-17-Styrofoam-Cups-and-Plates-and-Plastic-Products-Prohibition-and-Container-Deposit-Act-2016.pdf>

- Republic of the Philippines (2014) Ordinance No. 2014-05. Province of Guimaras, Office of the Sangguniang Panlalawigan. July 23rd, 2014 [Online] http://www.guimaras.gov.ph/images/8th_Sangguniang_Panlalawigan/OrigOrdinances/2014/2014-05.pdf
- Republic of the Philippines (2017) Resolution No. 125-S-2012: A resolution approving provincial ordinance No. 007-2012. Province of Cavite, Office of the Sangguniang Panlalawigan April 10th, 2012 [Online] <http://generaltrias.gov.ph/wp-content/uploads/2012/10/PROVINCIAL-ORDINANCE-NO.007-2012Regulating-the-use-of-Plastic.pdf>
- Republique Togolaise (2011) Décret No. 2011-003/PR fixant les modalités de gestion des sachets et emballages plastiques au Togo. Ministère du commerce et de la promotion du secteur privé; Ministère de la santé; Ministère de l'eau, de l'assainissement et de l'hydraulique villageoise; Ministère de l'administration territoriale, de la décentralisation et des collectivités locales porte-parole du gouvernement; Ministère de l'agriculture de l'élevage et de la pêche; Ministère des transports; Ministère de l'environnement et des ressources forestières; and Ministère de l'industrie, de la zone franche et des innovations technologiques. Signed in Lomé, January 5th, 2011 [Online] <http://extwprlegs1.fao.org/docs/pdf/tog143632.pdf>
- Retail Council of Canada (2008) B.C. industry brings in comprehensive plan on plastic bags. [Press Release] Retrieved from <http://www.newswire.ca/news-releases/bc-industry-brings-in-comprehensive-plan-on-plastic-bags-536660251.html>
- Retail Council of Canada (2017) Municipal by-laws on shopping bags in Quebec. Last updated July 2017 [Online] https://www.retailcouncil.org/sites/default/files/Municipal_bylaws_shopping_bags%20Quebec_Aug_2017.pdf
- Retail Council of Canada, the Canadian Federation of Independent Grocers, and the Canadian Association of Chain Drugstores (2012) Alberta Plastic Bag Distribution. Annual Report March 2012. [Online] <http://bvwaste.ca/wp-content/uploads/2013/01/Alberta-Plastic-Bags-Annual-Report-2012-Final.pdf>
- Revilla Jr., R.A. (2015) Plastic Bag Regulation Act of 2015. Senate of the Philippines, 16th Congress. Senate Bill No. 2613 Filed February 2nd, 2015. [Online] https://www.senate.gov.ph/lis/bill_res.aspx?congress=16&q=SBN-2613
- Roach, J. (2003) Are Plastic Grocery Bags Sacking the Environment. National Geographic News. Published September 2nd, 2003. [Online] https://news.nationalgeographic.com/news/2003/09/0902_030902_plasticbags.html
- Romania Journal (2017) Plastic bags to be banned in Romania. Published October 6th, 2017 [Online] <http://www.romaniajournal.ro/plastic-bags-to-be-banned-in-romania/>
- Rosenthal, E. (2008) By 'bagging it', Ireland rids itself of a plastic nuisance. New York Times. Published January 31st, 2008. [Online] <http://www.nytimes.com/2008/01/31/world/europe/31iht-bags.4.9650382.html>

- Rutan Poly Industries Inc. (2015) The History of Plastic Bags. Posted June 30th, 2015 [Online] <http://rutanpoly.com/the-history-of-plastic-bags/>
- Sabah Ministry of Tourism, Culture and Environment (2017) Reduce plastic bag use August. [Online] <http://kepkas.sabah.gov.my/2017/06/28/reduce-plastic-bag-use-august/>
- Sall, M. (2015) Loi No. 2015-09 du 04 mai 2015 relative à l'interdiction de la production, de l'importation, de la détention, de la distribution, de l'utilisation de sachets plastiques de faible micronnage et à la gestion rationnelle des déchets plastiques. République du Sénégal, Journal Officiel No. 6859. Dakar, Published July 4th, 2015. pp. 621-623 [Online] <http://www.douanes.sn/sites/default/files/fichiers/FC-7989.pdf>
- Saloj-Chiyal, B.L. (2017) To help conserve Lake Atitlan, town bans plastic bags. Global Press Journal, Published May 4th, 2017 [Online] <https://globalpressjournal.com/americas/guatemala/to-help-serve-lake-atitlan-town-bans-plastic-bags/>
- San Francisco Department of Environment (2016) Checkout Bag Ordinance. [Online] <https://sfenvironment.org/article/checkout-bag-ordinance>
- Saskatchewan Association of Rural Municipalities (2014) Banning of Plastic Grocery Bags. [Online] <http://sarm.ca/advocacy/resolutions/item/?n=856>
- Scientific American (2015) Do plastic bag bans work. [Online] <https://www.scientificamerican.com/article/do-plastic-bag-bans-work/>
- Scottish Statutory Instruments (2014) 2014 No. 161 Environmental Protection – The Single use Carrier Bags charge (Scotland) Regulations 2014. Published June 3rd, 2014. [Online] http://www.legislation.gov.uk/ssi/2014/161/pdfs/ssi_20140161_en.pdf
- Scuiller, L. (2016) Papua: plastic bags prohibited. Published February 1st, 2016, EnezGreen. [Online] <http://www.enezgreen.com/en/actualite/papua-plastic-bags-prohibited>
- Seaside City Council (2014) Ordinance No. 1017. August 21st, 2014. [Online] <https://www.ci.seaside.ca.us/DocumentCenter/View/322>
- Secretaria Distrital de Ambiente (2011) Bogota : una ciudad hacia el uso racional de las bolsas plasticas. Published May 11th, 2011 [Online] <http://oab.ambientebogota.gov.co/es/con-la-comunidad/noticias/bogota-una-ciudad-hacia-el-uso-racional-de-las-bolsas-plasticas>
- Seguchi, R. & Hotta, Y. (2013) Best Practices and Recommendations for Waste Reduction: Towards sustainable consumption. Friends of the Earth Japan in collaboration with the Institute for Global Environmental Strategies. March 2013. [Online] <http://www.foejapan.org/en/waste/policy/pdf/140227.pdf>

- Seoul Metropolitan Government (2017) Seoul to take measures to reduce single-use plastic bags. Published September 19th, 2017 [Press Release] <http://english.seoul.go.kr/seoul-take-measures-reduce-single-use-plastic-bags/>
- Sharp A & Wheeler M 2012 South Australian Plastic Bag Ban, An empirical evaluation, Ehrenberg-Bass Institute for Marketing Science, University of South Australia, prepared for Zero Waste SA, Government of South Australia
- Shera, U. (2017) Tirana municipality working to reduce plastic bag use. Albanian Telegraphic Agency, Published September 20th, 2017 [Online] <https://www.ata.gov.al/tirana-municipality-working-to-reduce-plastic-bag-use/>
- Sibon, P. (2017) DBKU to ban plastic bags by 2018. The Borneo Post. Published January 4th, 2017 [Online] <http://www.theborneopost.com/2017/01/04/dbku-to-ban-plastic-bags-by-2018/>
- Sibu Municipal Council (2017) SMC specifies 3 days in a week as no-plastic day from October. Published September 25th, 2017 [Online] http://www.smc.gov.my/modules/web/pages.php?mod=news&sub=news_view&nid=271
- Slevin C. (2009) Colorado lawmakers bag statewide plastic bag ban. The San Diego Union-Tribune, Associated Press. Published February 25th, 2009. [Online] <http://www.sandiegouniontribune.com/sdut-plastic-bags-colorado-022509-2009feb25-story.html>
- Slezak, M. (2017) Woolworths and Coles to phase out single-use plastic bags. The Guardian, July 14th, 2017. [Online] <https://www.theguardian.com/environment/2017/jul/14/woolworths-to-phase-out-single-use-plastic-bags-over-12-months>
- The Slovak Spectator (2017) Parliament passed ban on giving plastic bags for free. Published March 23rd, 2017. [Online] <https://spectator.sme.sk/c/20491160/parliament-passed-ban-on-giving-out-plastic-bags-for-free.html>
- Smith, C. (2013) Italy bags the plastic. Urbino Project 2013: Multimedia Journalism in Italy. Published June 30th, 2013. [Online] <http://2013.inurbino.net/plastic-bags/>
- Smith, C. (2017) Plastic bag deterrent fee here to stay. Loop News Barbados. Published June 3rd, 2017. [Online] <http://www.loopnewsbarbados.com/content/plastic-bag-deterrent-fee-here-stay>
- Soft Plastics Recycling (2017) Home – Partners. [Online] <http://www.recycling.kiwi.nz/solutions/soft-plastics>
- Sotherar, K. & Stackhouse, R. (2016) Extra charge for grocery bags nears as law is finalized. The Cambodian Daily. Published October 18th, 2016. [Online] <https://www.cambodiadaily.com/news/extra-charge-grocery-bags-nears-law-finalized-119425/>

- Sossu, I. (2016) Bénin : l'usage de sacs plastiques (sachets) bientôt interdit par une loi. Benin Web TV. Published August 11th, 2016. [Online] <https://beninwebtv.com/2016/08/benin-lusage-de-sacs-plastiques-sachets-bientot-interdit-loi/>
- South Australia EPA (2017) Plastic bag ban. Data & Publications. Last updated January 20th, 2017 [Online] http://www.epa.sa.gov.au/data_and_publications/all_publications/for_councils/plastic_bag_ban
- South Korea Ministry of Environment (2013) Waste Prevention Policy. Last updated October 29th, 2013. [Online] <http://eng.me.go.kr/eng/web/index.do?menuId=141>
- The Star (2016-A) Total ban on plastic bags in Malacca to be enforced strictly. Published January 6th, 2016 [Online] <https://www.thestar.com.my/metro/community/2016/01/06/total-ban-on-plastic-bags-in-malacca-to-be-enforced-strictly/>
- The Star (2016-B) Saying 'no' to plastic bags is in the bag. Published December 28th, 2016 [Online] <https://www.thestar.com.my/opinion/columnists/the-star-says/2016/12/28/saying-no-to-plastic-bags-is-in-the-bag/>
- The Star (2017-A) No more plastic bags in Johor supermarkets. Published June 14th, 2017 [Online] <https://www.thestar.com.my/news/nation/2017/06/14/no-more-plastic-bags-in-johor-supermarkets/>
- The Star (2017-B) Perak plastic ban on hold. Published May 23rd, 2017 [Online] <https://www.thestar.com.my/news/nation/2017/05/23/perak-plastic-ban-on-hold-mb-proper-studies-needed-before-prohibiting-usage-statewide/>
- The Star (2017-C) Sabah to bring back no plastic bag campaign. Published June 21st, 2017 [Online] <https://www.thestar.com.my/news/nation/2017/06/21/sabah-to-bring-back-no-plastic-bag-campaign/>
- State of Arizona (2016) HB 2131. Introduced by Representative Peterson. House of Representatives: Fifty-second Legislature, Second regular session. Passed on March 14th, 2016 [Online] <https://legiscan.com/AZ/text/HB2131/id/1292045>
- State of Michigan (2016) Enrolled Senate Bill No. 853. Introduced by Senators Stamas, Horn, Brandenburg, Shirkey and Schmidt. 98th Legislature, Regular Session 2016. Approved December 28th, 2016 [Online] <http://www.legislature.mi.gov/documents/2015-2016/publicact/pdf/2016-PA-0389.pdf>
- State of Minnesota (2017) 2017 Minnesota Statutes: 471.9998 merchant bags. Revisor of Statutes. [Online] https://www.revisor.mn.gov/statutes?id=471.9998&year=2017&keyword_type=all&keyword=plastic+bag
- State of Rhode Island General Assembly (2017) House Bill 5946: an Act relating to health and safety. Introduced by Representatives Edwards, Canario, Kazarian, Amore and Lima. [Online] <http://webserver.rilin.state.ri.us/BillText/BillText17/HouseText17/H5946.pdf>

- Statutory Rules of Northern Ireland (2013) 2013 No. 4 Environmental Protection – The Single Use Carrier Bags Charge Regulations (Northern Ireland) 2013. Department of Environment. Published January 15th, 2013. [Online] http://www.legislation.gov.uk/nisr/2013/4/pdfs/nisr_20130004_en.pdf
- The Straits Time (2013) Tax slashes use of plastic bags in NUS shops and canteens. Asia One, Published September 4th, 2013 [Online] <http://www.asiaone.com/singapore/tax-slashes-use-plastic-bags-nus-shops-and-canteens>
- The Straits Times (2017) Ban on non-biodegradable plastic bags takes effect in Malaysia's Federal Territories. Published September 2nd, 2017. [Online] <http://www.straitstimes.com/asia/se-asia/ban-on-non-biodegradable-plastic-bags-takes-effect-in-malaysias-federal-territories>
- Suzuki, D. (2012) Are Plastic Bags Really Necessary? The David Suzuki Foundation. Published August 2, 2012. [Online] <http://www.davidsuzuki.org/blogs/science-matters/2012/08/are-plastic-bags-really-necessary/>
- Svet Kapitala (2017) V Sloveniji od leta 2019 prepoved brezplačnih plastičnih vrečk. Published July 6th, 2017. [Online] http://svetkapitala.delo.si/aktualno/v-sloveniji-od leta-2019-prepoved-brezplacnih-plasticnih-vreck-2697?meta_refresh=true
- Sydney Morning Herald (2004) Suburb to be Sydney's first plastic bag free zone. Published May 7th, 2004 [Online] <http://www.smh.com.au/articles/2004/05/06/1083635285044.html>
- Taiwan Environmental Protection Administration (2003) 80% reduction in plastic bag consumption over six months. Environmental Policy Monthly. July 2003, Volume VI, Issue 7
- Taiwan Environmental Protection Administration (2017) Plastic bag reduction to be expanded. Last updated August 24th, 2017. [Online] <https://www.epa.gov.tw/ct.asp?xItem=61822&ctNode=35637&mp=epaen>
- Tamminen, T. (2011) Afghanistan banned plastic bags, can they also go farther than the U.S. in fixing air pollution? Published June 16th, 2011. [Online] <https://www.fastcompany.com/1760552/afghanistan-banned-plastic-bags-can-they-also-go-farther-us-fixing-air-pollution>
- Tasmania EPA (2013) Plastic Shopping Bags. [Online] <http://epa.tas.gov.au/sustainability/resources-for-the-community/plastic-shopping-bags>
- Teasdale, M. (2013) Plastic bags: Singapore litter gets worse. Gaia Discovery. Published August 4th, 2013 [Online] <https://www.gaiadiscovery.com/corporate-social-responsibility/plastic-bags-singapore-litter-gets-worse.html>

- Tekleberhan, M. (2011) Ethiopia bans plastic bag import. Published November 25th, 2011. [Online] <http://www.2merkato.com/news/alerts/607-ethiopia-bans-plastic-bag-import>
- Thalassa Foundation (2015) Alonissos: the first island without plastic bags in Greece. Published December 1st, 2015 [Online] <http://thalassafoundation.com/en-GB/news/news-2015/alonissos-the-first-island-without-plastic-bags-in-greece>
- The Times of Jaipur (2014) Despite Ban, Plastic bags litter state. Published October 10th, 2014. [Online] <http://epaperbeta.timesofindia.com/Article.aspx?eid=31810&articlexml=Despite-Ban-Plastic-Bags-Litter-State-10102014002031>
- Thulin, S.G. (1965) U.S. Patent No. 3,180,557 A. Celloplast Ab
- Tiwi News (2004) Community Goes Green. Issue 9, p.5. Published December 3rd, 2004 [Online] http://www.territorystories.nt.gov.au/bitstream/10070/223389/1/news_December_3.pdf
- Tossavi, L. (2017) Atelier sur l'interdiction des sachets plastiques au Bénin; Pour un egestion efficace des déchets. La nouvelle Tribune. Published August 17th, 2017. [Online] <https://lanouvelletribune.info/2017/08/atelier-interdiction-sachets-plastiques-benin/>
- Town of Fogo Island (2015) Town News: End of plastic grocery bags on Fogo Island. Published June 1st, 2015 [Online] <http://www.townoffogoisland.ca/home/blog-240>
- Trash Reduction Act of 2013, H.R. 1686, 113th Congress (2013)
- Trash Reduction Act of 2015, H.R. 3977, 114th Congress (2015)
- The Tribune India (2017) No check on polybags smuggled into state from Delhi, Gujarat. Published December 5th, 2017 [Online] <http://www.tribuneindia.com/news/punjab/no-check-on-polybags-smuggled-into-state-from-delhi-gujarat/508258.html>
- Tsunoda, I. (2007) Global warming measures starting with waste reduction in Sendai, Miyagi Prefecture. Japan for Sustainability, September 2007 [Online] https://www.japanfs.org/en/news/archives/news_id027947.html
- Tubei, G. (2017) What Kenya can learn from these African countries that have tried to ban plastics. Business Insider by Pulse Live. Published August 29th, 2017. [Online] <http://www.pulselive.co.ke/bi/strategy/plastic-pollution-what-kenya-can-learn-from-these-african-countries-that-have-tried-to-ban-plastics-id7218228.html>
- Turkiye Perakendeciler Federasyonu (2017) vegetable-fruit basket will be cheaper to fill. In News. Published March 29th, 2017. [Online] <http://www.tpf.com.tr/sebze-meyve-sepeti-daha-ucuza-dolacak/>

- Tuoi Tre News (2017) Vietnam considers fivefold gallop in plastic bag tax. Published September 28th, 2017 [Online] <https://tuoitrenews.vn/news/business/20170928/vietnam-considers-fivefold-gallop-in-plastic-bag-tax/41784.html>
- TVNZ (2009) The Warehouse to charge for plastic bags. Published March 18th, 2009. [Online] <http://tvnz.co.nz/content/2560577/2591764.xhtml>
- United Nations (2005) Press Conference on Community Commons – local perspectives on millennium development goals. Press conference June 20th 2005. [Online] http://www.un.org/press/en/2005/MDGs_Press_Conference_050620.doc.htm
- United Nations (2015) Institut National d'Études Démographiques: UN Simulation. [Online] https://www.ined.fr/en/everything_about_population/population-games/tomorrow-population/
- United Nations (2017) Fight against plastic bags: UN in Albania. The Ocean Conference: 5-9 June 2017. [Online] <https://oceanconference.un.org/commitments/?id=17098>
- United Nations Environment Programme (2015) Burkina Faso endorses law on sustainable development and bans non-biodegradable plastic bags. UNDP-UNEP Poverty-Environment Initiative. [Online] <http://www.unpei.org/latest-news/burkina-faso-endorses-law-on-sustainable-development-and-bans-non-biodegradable-plastic-bags>
- United Nations Environment Program – Nicaragua (2015) Comunidad de Little Island anuncia fin de la bolsa plastica. Published January 21st, 2015 [Online] <http://www.ni.undp.org/content/nicaragua/es/home/presscenter/articles/2015/01/21/comunidad-de-little-island-anuncia-fin-de-la-bolsa-pl-stica.html>
- United Nations Environment Programme (2017) UN Declares war on ocean plastic. Published February 23rd, 2017. [Online] <http://www.unep.org/newscentre/un-declares-war-ocean-plastic>
- United Nations Environment Programme (2017) UN Environment 2016 Annual Report: Antigua and Barbuda says good riddance to plastic bags. [Online] <http://www.unep.org/annualreport/2016/index.php?page=5&lang=en>
- Valls, M. (2016) Décrets, arrêtés, circulaire : Décret no 2016-379 du 30 mars 2016 relatif aux modalités de mise en œuvre de la limitation des sacs en matières plastiques à usage unique. Ministère de l'Environnement, de l'Énergie et de la Mer, en charge des relations internationales sur le climat. Published March 30th, 2016. [Online] https://www.legifrance.gouv.fr/jo_pdf.do?id=JORFTEXT000032319878
- Valqui Matos, N.A. (2013) Proyecto de Ley – Ley de promoción del uso de bolsas biodegradables. Proyecto de Ley No.º2967/2013-CR. Congreso de la Republica del Peru. Lima, Peru. Published November 21st, 2013

- Vara, Al. (2013) The Plastic Bag Agreement. Catalan Waste Agency [Powerpoint presentation] Review meeting of the regional plan on marine litter management, May 17-18, 2013. Barcelona, Spain.
- Vermont General Assembly (2017-A) Bill H.88. Introduced by Representatives Yantachka, McCormack, Sullivan, Christensen, Dunn and Gannon. [Online] <http://legislature.vermont.gov/assets/Documents/2018/Docs/BILLS/H-0088/H-0088%20As%20Introduced.pdf>
- Vermont General Assembly (2017-B) Bill H.105. Introduced by Representatives Mrowicki, Squirrel and Till. [Online] <http://legislature.vermont.gov/assets/Documents/2018/Docs/BILLS/H-0105/H-0105%20As%20Introduced.pdf>
- Vidal, J. (2007) Welcome to Modbury: Just don't ask for a plastic bag. The Guardian, Published April 28th, 2007 [Online] <https://www.theguardian.com/environment/2007/apr/28/plasticbags.frontpagenews>
- Vietnam Law and Legal Forum (2011) Environmental Protection Tax. Published August 30th, 2011 [Online] <http://vietnamlawmagazine.vn/environmental-protection-tax-4058.html>
- Villacorta, C.T. (2014) Proyecto de ley para la prevencion y control de los riesgos del uso de las bolsas plasticas en mercados o supermercados. Proyecto de ley No.º3208/2013-CR. Congreso de la Republica del Peru. Lima, Peru. Published March 4th, 2014
- Ville de Deux-Montagnes (2013) Virage vert : Interdiction de distribuer des sacs de plastique – un règlement qui protège l'environnement efficacement [Online] <http://www.ville.deux-montagnes.qc.ca/virage-vert/>
- Ville de Deux-Montagnes (2014) Entrée en vigueur : Règlement No. 1533. Published September 16th, 2014 [Online] http://www.ville.deux-montagnes.qc.ca/wp-content/uploads/2013/04/Sept1533_-Entr%C3%A9e_vigueur.pdf
- Ville de Saint-Basile-le-Grand (2017) Interdiction d'utilisation de sacs de plastique dans les commerces. Last updated September 20th, 2017 [Online] <https://www.ville.saint-basile-le-grand.qc.ca/vie-citoyenne/reglementation/reglements/interdiction-utilisation-sacs-plastique-commerces/>
- Ville de Saint-Bruno-de-Montarville (2017) Bannissement des sacs de plastiques à usages unique. [Online] <http://www.stbruno.ca/ecosac>
- Ville de Ste-Martine (2011) Interdictions des sacs de plastiques. [Online] http://www.municipalite.sainte-martine.qc.ca/cgi-bin/index.cgi?page=p1_7_9&langue=
- Ville de Varennes (2017) Bannissement des sacs de plastique à usage unique : la MRC de Marguerite-d'Youville fait sa part. Published September 25th, 2017[Online]

<https://www.ville.varenes.qc.ca/une/20170925-bannissementdessaacsdeplastiqueausageuniqueclamrcdemargueritedyouvillefaitsapart%21>

- Vos, J. (2017) Western Cape DA passes motion to reduce plastic bag waste. Western Cape Democratic Alliance. Published October 9th, 2017. [Online] <https://www.da.org.za/2017/10/western-cape-da-passes-motion-reduce-plastic-bag-waste/>
- Wakhungu, J.W. (2017) The environment management and co-ordination Act. Gazette Notice No. 2356. The Kenya Gazette. Vol. CXIX – No.31. Nairobi, March 14th, 2017.
- Walmart Canada (2016) Walmart Canada aims to reduce plastic waste. Mississauga, ON. Published January 25th, 2016. Mississauga, ON. [Online Press Release] http://www.walmartcanada.ca/_news_/news-archive/2016/01/25/walmart-canada-aims-to-reduce-plastic-waste
- Wardhani, D.A. (2016) Jakarta withdraws from plastic bag charge program. The Jakarta Post. Published February 25th, 2016 [Online] <http://www.thejakartapost.com/news/2016/02/25/jakarta-withdraws-plastic-bag-charge-program.html>
- The Warehouse (2016) Warehouse in the community. [Online] <http://www.thewarehousegroup.co.nz/community-environment/the-warehouse-community>
- Waste Management Review (2017) The effect of banning the bag. Published December 6th, 2017 [Online] <http://wastemanagementreview.com.au/ban-the-bag-debate/>
- Waters, A. (2015) Environmental effects of the single-use bag ordinance in Austin, Texas. Austin Resource Recovery and the Zero Waste Advisory Commission. June 10th, 2015 [Online] <https://www.austintexas.gov/edims/document.cfm?id=232679>
- Welsh Government (2016) Single-use carrier bags. Published October 6th, 2016 [Online] http://gov.wales/topics/environmentcountryside/epq/waste_recycling/substance/carrier_bags/?lang=en
- Welsh Statutory Instruments (2010) 2010 No. 2880 (W.238) Environmental Protection, Wales – The Single Use Carrier Bags Charge (Wales) Regulations 2010. Published November 30th, 2010. [Online] http://www.legislation.gov.uk/wsi/2010/2880/pdfs/wsi_20102880_mi.pdf
- Western Australia Local Government Association (2016) Discussion paper: Plastic bags. Published August 2016. [Online] http://www.wastenet.net.au/Profiles/wastenet/Assets/ClientData/FINAL_Discussion_Paper_on_Plastic_Bags_August_2016.pdf
- Whole Foods Market (2008) Whole Foods Market to sack disposable plastic grocery bags by Earth Day. Austin, TX. Published January 22nd, 2008. [Online Press Release] <http://media.wholefoodsmarket.com/news/whole-foods-market-to-sack-disposable-plastic-grocery-bags-by-earth-day>

- Wijnen, P. (2017) Grocery chains introduced plastic bag fee. Norway Today. Published May 30th, 2017. [Online] <http://norwaytoday.info/everyday/plastic-bag-fee-grocery-chains/>
- Wisconsin State Legislature (2016) 2015 Wisconsin Act 302. Published March 31st, 2016 [Online] <http://docs.legis.wisconsin.gov/2015/related/acts/302>
- Woolworths Group (2017, July 14) Woolworths Group announces move away from single-use lightweight plastic shopping bags nationwide. [Online Press Release] https://www.woolworthsgroup.com.au/page/media/Latest_News/woolworths-group-announces-move-away-from-single-use-lightweight-plastic-shopping-bags-nationwide/
- World Wildlife Fund Canada (2009) Loblaw launches national plastic shopping bag reduction program. Brampton, ON. Published April 20th, 2009. [Online Press Release] <http://www.wwf.ca/newsroom/?3500>
- World Wildlife Fund Global (2017) Don't let plastic choke the planet. Posted June 28th, 2017 [Online] http://wwf.panda.org/wwf_news/?303950/Dont-let-plastic-choke-the-planet
- Xuereb, M. (2009) Eco tax on plastic bags from March 1. Times of Malta. Published January 29th, 2009. [Online] <https://www.timesofmalta.com/articles/view/20090129/local/eco-tax-on-plastic-bags-from-march-1.242668>
- You, L. (2017) Experts Question China's Ban on Free Plastic Bags. Published June 13th, 2017 [Online] <http://www.sixthtone.com/news/1000322/experts-question-chinas-ban-on-free-plastic-bags>
- Young, T. (2010) Rajasthan bans use of plastic bags. Business Green. Published July 28th, 2010 [Online] <https://www.businessgreen.com/bg/news/1802454/rajasthan-bans-plastic-bags>
- Zen, Ahmad & Omar (2013) No plastic bag campaign day in Malaysia and the policy implication. Environment, Development and Sustainability, Volume 15, p.1259-1269. Published January 25th, 2013
- Zero Waste Australia (2011) Plastic bag ban. Last updated February 28th, 2011 [Online] <http://www.zerowaste.sa.gov.au/plastic-bags>
- Zolijargal, M.(2013) Less paper, more plastic. The UB Post. Posted April 15th, 2013. [Online] <http://ubpost.mongolnews.mn/?p=3657>
- Zona Libre de Plastico (2017) Linea de accion 1 : Incentivos municipales para sustituir plastico de un solo uso por materiales renovables y compostables. [Online] <http://www.zonalibredeplastico.org/linea-de-accion/incentivos-municipales-para-sustituir-plastico-de-un-solo-uso-por-materiales>